



ASPA 2019 ANNUAL CONFERENCE PROGRAM

A CALL FOR ACTION

ADVANCING PUBLIC SERVICE

March 8-12 | Washington, DC | #ASPA2019

Celebrating 80 Years

PUBLIC FINANCE

INFRASTRUCTURE

SOCIAL EQUITY

PUBLIC SERVICE

**GLOBAL PUBLIC
ADMINISTRATION**



AMERICAN UNIVERSITY
SCHOOL OF PUBLIC AFFAIRS

Celebrating 85 Years of Excellence

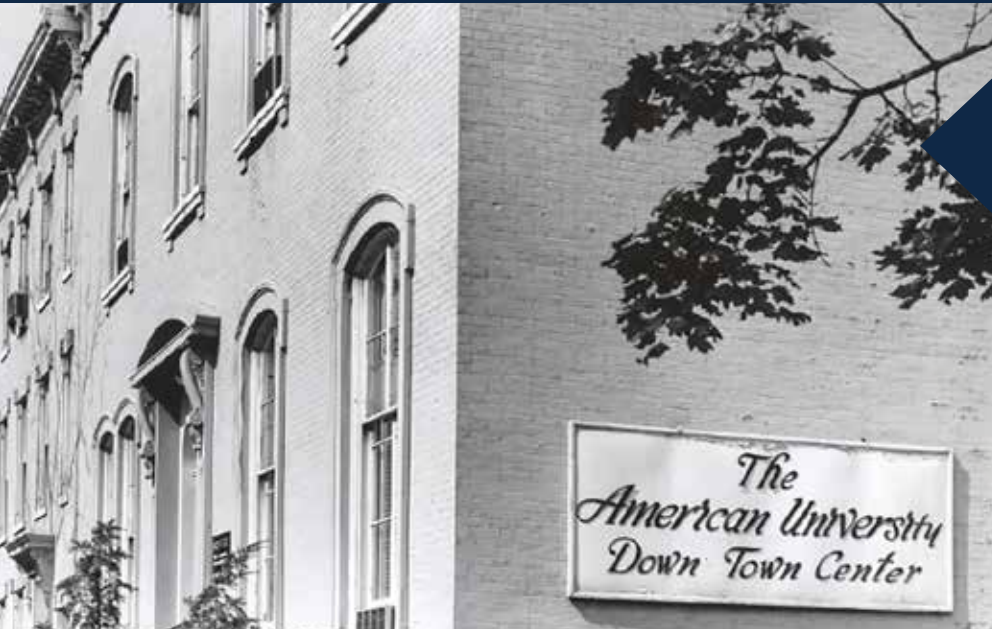

In 1934, American University School of Public Affairs was established as part of President Franklin Delano Roosevelt's New Deal. From FDR's vision for "practical contacts between the collegiate and educational world, and the operations of government," the School of Public Affairs at American University was born.

For 85 years, SPA has been committed to training, educating, informing, and elevating public servants.

Thank you, public servants, for your service and for making our communities, states, and country better every day.

www.american.edu/spa



SCHOOL *of*
PUBLIC AFFAIRS

AMERICAN UNIVERSITY • WASHINGTON, DC

Welcome Letters.....	2
ASPA Officers and The National Council.....	5
Content Leads.....	6
Conference Sponsors.....	8
Founders' Fellows Supporters	12
General Information	13
Hotel Floor Plan	15
Conference at a Glance	16
Chapter, Section, Journal Meetings.....	18
A Guide to the 2019 Annual Conference Tracks.....	19
ASPA Sections.....	20
ASPA Past Presidents	21
Exhibit Hall/Exhibitors	22

Plenaries and Lectures

Opening Plenary.....	25
Elliot Richardson Lecture	28
Gloria Hobson Nordin Social Equity Award Luncheon	29
Public Service Plenary	30
Global Public Administration Plenary and International Assembly	31
Section for Women in Public Administration National Awards Breakfast.....	32
Donald C. Stone Lecture.....	33
Closing Plenary	34

Special Events and Activities

Presidential Panels.....	37
Partner Organization Sessions	58
Welcome Reception	59
Student and New Professional Summit.....	60
Founders' Fellows Reception	63
Founders' Fellows Panels	64
National Public Service Awards	65
2019 Society Awards.....	68
2019 Section Awards	70
Networking Events.....	74

FRIDAY, March 8, 2019

Overview	75
Sessions	77

SATURDAY, March 9, 2019

Overview	105
Sessions	107

SUNDAY, March 10, 2019

Overview	133
Sessions	135

MONDAY, March 11, 2019

Overview	159
Sessions	161

TUESDAY, March 12, 2019

Overview	193
Sessions	194

Conference Leaders	205
Advertisers.....	206
Presenter Directory.....	207
ASPA Life Members.....	217
Charter Members.....	218
ASPA 50 and 25 Year Members.....	218
Code of Conduct	219



1730 Rhode Island Ave., NW, Suite 500 • Washington, DC 20036
Telephone: 202-393-7878 • Fax: 202-638-4952 • www.aspanet.org

Dear Colleagues:

Eighty years ago, our Society's founders set forth a mission as bold and encompassing as the field in which we practice, study, teach and research: to *advance excellence in public service*. As the leading professional public service organization bridging the practitioner and academic communities, we have seen our field evolve, become more specialized and face ever increasing pressures on the men and women dedicated to doing the public good. Despite these changes and the passage of time, ASPA has remained steadfast in our mission, one that remains as relevant today as ever before.

It is in this spirit that we welcome to Washington, DC for our Society's 80th Annual Conference. Against the backdrop of unprecedented challenges for our field, it is in many ways appropriate that we gather not only where our national government is rooted, but where state and local governments and private and nonprofit organizations intersect in very special ways. Our host city is a microcosm of our entire public service sector; we all can learn from being here.

Our conference theme, *A Call for Action: Advancing Public Service*, encourages dialogue aimed at generating actionable ideas to help us *serve* across four critical, high impact areas: infrastructure, public finance, public service and social equity. Our fifth track—global public administration—recognizes that our field is an interconnected one, spanning geographic boundaries. We encourage you to make the most of this conference, including new features that will enable you to engage in different ways. Our five topical tracks provide a focused experience that drills in on our most critical challenges; you can be as concentrated or general as you wish with your learning experience. Taking place throughout the conference pop-up panels will allow you to continue discussions with your peers outside formalized panels. Eighteen presidential panels will bring forth insights on the critical issues of our time from some of the most informed experts across the field.

In keeping with our robust history, we will honor individuals who embody the ideals of those for whom our lectures are named, recognizing excellence in practice, academia and advancing social equity, one of ASPA's core values. We will honor career-long public service excellence through the National Public Service Awards and, of course, recognize the next generation of public service leaders through the 2019 class of Founders' Fellows.

Please join us for the welcome reception, taking place here at the historic Mayflower Hotel, where you can network with colleagues and friends, enjoy entertainment and celebrate our 80th anniversary in style. Taking place Sunday and Monday evenings, university and group receptions will offer even more occasions for you to network with your peers and honor individuals for their accomplishments. We are most grateful to those individuals and organizations that have generously supported our receptions—and the entirety of our conference—through sponsorships, contributions and other gifts. You have made this event possible.

We extend a warm greeting to those who have made attending our conference an annual tradition. For those joining us for the first time, we know you will find this conference to be a welcoming place to forge new professional and personal relationships; we hope this is the first of many you will attend.

Thank you for attending our Society's 2019 Annual Conference. We are grateful to each of you for actively and meaningfully engaging in our work. We salute your dedication and commitment to public service, in the United States and around the world.

Jane Pisano
2018-2019 President

Bill Shields
Executive Director

Dear Conference Attendees:

Welcome to Washington, D.C.—the epicenter of the United States public service and nonprofit administration fields. Also, to us at The School of Public Affairs (SPA) at American University, it's our hometown.

At SPA, we celebrate our shared commitments with ASPA—promoting the value of joining and elevating the public service profession, achieving innovative solutions in governance and providing education and professional development for those committed to public service.

This month marks SPA's 85th anniversary. In 1934, the School of Public Affairs at American University was established to train federal employees with the skills needed for President Franklin D. Roosevelt's pioneering New Deal legislation.

At the school's dedication, FDR shared his vision for “practical contacts between the collegiate and educational world, and the operations of government.” He believed that the collaboration of academia and public service would result in better decisionmaking, not only for Depression-era Americans, but also for future generations.

For more than eight decades, we have married FDR's vision with the theoretical and practical skills public service professionals need, working toward this year's ASPA meeting theme of advancing public service.

The school is grateful for public servants—many of whom are SPA alumni—who make our communities, states and country better every day. We are also proud of AU President Sylvia Burwell, who has dedicated a lifetime commitment to public service and will deliver the 2019 Donald C. Stone lecture.

We look forward to robust conversations and exciting ideas throughout the conference. Our thanks go to each and every one of you in public service. We are committed to your advancement.

Sincerely,



Vicky Wilkins
Dean
American University School of Public Affairs

Politics & Public Administration Books from Routledge

Free global shipping + 20% off your order at booths 8,9,&12!



Public Service Ethics
Individual and Institutional Responsibilities
James S. Bowman,
Jonathan P. West

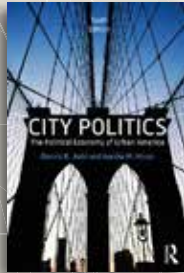

City Politics
The Political Economy of Urban America
Dennis R. Judd, Annika M. Hinze

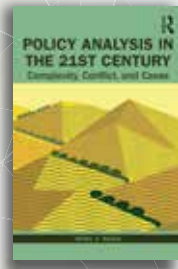

Policy Analysis in the Twenty-First Century
Complexity, Conflict, and Cases
Beryl Radin



The Public Administration Profession
Policy, Management, and Ethics
Bradley S. Chilton, Stephen M. King, Viviane E. Foyou, J. Scott McDonald



The Routledge Handbook of LGBTQIA Administration and Policy
Edited by Wallace Swan

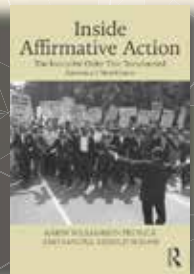

Inside Affirmative Action
The Executive Order That Transformed America's Workforce
Karin Williamson Pedrick,
Sandra Arnold Scham



Emergency Management: The American Experience
Claire B. Rubin



Public Sector Enterprise Risk Management
Advancing Beyond the Basics
Edited by Kenneth C. Fletcher,
Thomas H. Stanton

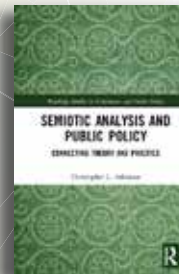

Semiotic Analysis and Public Policy
Connecting Theory and Practice
Christopher L. Atkinson

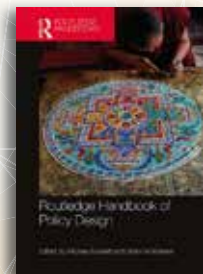

Routledge Handbook of Policy Design
Edited by Michael Howlett,
Ishani Mukherjee

Recent titles in the ASPA Series in Public Administration and Public Policy Edited by David H. Rosenbloom



Making Collaboratives Work
How Complex Organizational Partnerships Succeed
Susan Meyers Chandler



Transforming Disaster Response
Federalism and Leadership
William Lester

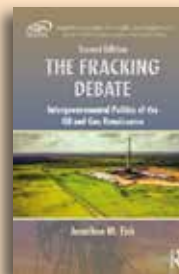

The Fracking Debate
Intergovernmental Politics of the Oil and Gas Renaissance
Jonathan M. Fisk



Researcher-Policymaker Partnerships
Strategies for Launching and Sustaining Successful Collaborations
Edited by Jenni W. Owen, Anita M. Larson

routledge.com/politics

Routledge Politics

@Rout_PoliticsIR

Routledge
Taylor & Francis Group

Routledge... think about it
www.routledge.com

ASPA OFFICERS AND THE NATIONAL COUNCIL

Welcome You to the Society's 80th Annual Conference



Jane Pisano
President



Paul Danczyk
President-Elect



Kendra Stewart
Vice President



Janice Lachance
Immediate Past President



William Shields, Jr.
Executive Director

NATIONAL COUNCIL

District I

Michael Ahn
Maria D'Agostino
Joshua Osowski

District II

Michael Brintnall
Diane Disney
Angela Kline

District III

Thomas Barth
Jared Llorens
Terry Murphy

District IV

J. Paul Blake
Suzanne Discenza
Stephen Kleinschmit

District V

Galia Cohen
Rex Facer, II
Aziza Zemrani

International Director

Allan Rosenbaum

Student Representative

Christopher Pierce

COMPA Representative

Loretta Tillery

Global Public Administration Track

Rich Callahan



Rich Callahan's research, consulting, publications and teaching focuses on leadership behaviors, strategy and performance management practices that are effective in complex and dynamic environments in the public sector. He is a professor at the University

of San Francisco, with a joint appointment in the School of Management and the School of Nursing and Health Professions. He is also an elected fellow in the National Academy of Public Administration and the current editor of the *International Journal of Public Leadership*. He was a visiting researcher at Oxford University in 2016, the Visiting Scholar 2018 for the Center for California Studies and a Fulbright Specialist award in 2011 for lectures on public institutions at Aydin University, Istanbul, Turkey. He has been published in journals such as *Public Administration Review*, *Public Management Review*, *Government Finance Officers Review* and *The National Civic Review*.

Marilyn Rubin



Marilyn Rubin is a distinguished research fellow at the School of Public Affairs and Administration at Rutgers—Newark. She is also professor emerita of public administration and economics and former director of the MPA Program at John Jay College of the City University of New York

(CUNY). She has had more than 35 years of experience working as a consultant and advisor to high-level government officials in the United States and abroad on projects related to fiscal policy, economic development and strategic planning and has been a member of economic advisory boards to elected officials at the federal, state and local levels. She is a National Academy of Public Administration fellow and has been a member of editorial boards for *Public Administration Review* and *Public Budgeting and Finance*. She has edited books and book chapters and published several articles in many professional journals, as well as serving as a visiting professor at universities outside the United States including Xiamen University, Jiangxi University and Sun Yat Sen University in China. She has been a Fulbright senior specialist program advisor in Ecuador and Brazil, as well.

Infrastructure Track

Wendy Haynes



Wendy Haynes serves as special assistant to the vice president for university advancement at Bridgewater State University. A tenured full professor and former director of the NASPAA-accredited MPA program, Haynes brings a rich background of public service leadership, as well as scholarship,

teaching and consulting, to her new role. She is a seasoned “pracademic,” having served in a variety of state and local government leadership roles across the United States. Intrigued by systems for ensuring institutional accountability and smart strategic planning, she served for 13 years in the Massachusetts Office of Inspector General, most recently as first assistant inspector general for megaproject oversight. She is an ASPA past president, a NAPA fellow and deeply engaged in the State Department’s Young African Leader Initiative and Mandela Washington Fellowship. Haynes lives on Cape Cod with her husband and contends that being a grandmother is the best job ever.

John Kirlin



Distinguished professor of public policy John Kirlin is the founding director of McGeorge’s Public Policy Program, offering two degrees: master’s of public policy and master’s of public administration. He is the author of more than 100 articles, chapters and monographs, and 13 books. He

is a National Academy of Public Administration fellow and has served as a consultant to the State of California on matters ranging from species protection to oversight of local government debt and the interface of energy and environmental policies. He served as executive director of the Marine Life Protection Act Initiative as well, making recommendations to the California Fish and Game Commission for protection of marine life along the California coast, and as executive director of Delta Vision, reframing state water policies and ecosystem vitality in the Delta, foundational work for a major package of legislation enacted in 2009.

Public Finance and Public Service Tracks

Judy England-Joseph



Judy England-Joseph is a strategic advisor and former director of research with the Partnership for Public Service; an employee engagement consultant with CPSHR; and an adjunct professor at the Schar School of Policy and Government, George Mason University. She was formerly a

senior executive with the U.S. Government Accountability Office (GAO) and now works in its Center for Audit Excellence. Her work covers a wide range of organizational performance assessment, strategic planning, enterprise risk management, leadership and human capital management issues. She also develops and delivers training on the design and conduct of performance auditing for federal Inspectors General, State Auditors and Supreme Audit Institutions (GAO equivalents) around the world. While an executive at GAO, she led its work in the housing, community and economic development, small business, emergency management, telecommunications and energy areas. She oversaw more than 600 congressionally requested reviews of federal programs, many of which resulted in legislative actions, budgetary savings and improved government performance. She represented GAO by testifying in more than 100 congressional hearings, on national television, in the press and at national conferences. She is a National Academy of Public Administration fellow and a member of its Board of Directors, and president of ASPA's National Capital Area Chapter. She is a graduate of American University.

Track Sponsored By:



SCHOOL of
PUBLIC AFFAIRS

Social Equity Track

Susan T. Gooden



Susan T. Gooden is interim dean and professor of the L. Douglas Wilder School of Government and Public Affairs at Virginia Commonwealth University. She is an internationally recognized social equity expert, a National Academy of Public Administration fellow and ASPA past president. Her

research has been funded by several organizations including the Russell Sage Foundation, the Kellogg Foundation, the Smith Richardson Foundation, MDRC and the Manhattan Institute for Policy Research. Gooden was appointed to the Commission on Peer Review and Accreditation, the accrediting arm of the Network of Associated Schools of Public Policy, Affairs and Administration. She has served previously as an elected member to the national policy council of the Association for Public Policy Analysis and Management. In 2016, she was appointed to the Virginia Community College System board by Governor Terence McAuliffe. Gooden earned her master's degree from Virginia Tech and her doctorate from the Maxwell School of Citizenship and Public Affairs at Syracuse University.

Track Sponsored By:



Charles Menifield



Charles Menifield is dean of the School of Public Affairs and Administration at Rutgers University—Newark. His research interests lie primarily in the areas of budgeting and financial management, public health and welfare, and policing. Other areas include public management

information systems, education finance and public administration education. He has two books on minority politics and two on public budgeting and financial management. His most recent articles have appeared in *Public Administration Review*, the *Journal of Public Budgeting, Accounting and Financial Management*, *International Journal of Public Administration* and *State and Local Government Review*. His current research examines the impact of the CHIP program on reducing the number of uninsured children, changes in gun laws and police killings in the United States. He previously served as the associate dean in the School of Public Affairs at the University of Missouri—Columbia and the director of the public administration program at the University of Memphis.

CONFERENCE SPONSORS

ORGANIZATIONAL SPONSORS

Routledge, Taylor & Francis Group



Routledge Public Administration provides researchers, professionals, lecturers and students with high quality books, journals, e-products and resources across a wide range of subject areas such as public administration and management, urban politics, public policy and more.

Sponsored Event:

2019 Annual Conference

Wiley



Wiley has partnered with ASPA for more than 15 years to publish *Public Administration Review (PAR)*. We are proud of our strong relationship with ASPA and *PAR* and are delighted to support ASPA's Annual Conference. Our program includes some of the leading journals and books in public administration, management and public policy, a perfect resource for the ASPA membership. Please visit the Wiley booth for more information or go to www.wiley.com for a comprehensive list of the journals and books we publish.

Sponsored Event:

Exhibit Hall Reception

DIAMOND SPONSORS

American University



In 1934, one year after President Franklin Delano Roosevelt signed his famous New Deal legislation, The School of Public Affairs at American University was born to train many of those who were part of FDR's pioneering plan. What started as a program to instruct federal workers would grow into one of the top schools of public affairs in the nation. To this day, 85 years later, FDR's vision remains at the heart of our school: A vision of building a bridge between academic thought and policy planning, while inspiring change at every level. Our faculty, students and graduates are driven by a sense of higher purpose: the desire to make the world a better place. Read more about SPA at www.american.edu/spa.

Sponsored Events:

**Welcome Reception
Public Service Track
Exhibit Hall**

Haynes Foundation



Established in 1926 by a prominent, reform-minded physician and his suffragist wife, the John Randolph Haynes and Dora Haynes Foundation is a leading supporter of social science research for Los Angeles. It is also the oldest private foundation in the city. Over the years, the Foundation has funded hundreds of important urban studies in the areas of education, transportation, local government, elections, public safety, demographics, public personal services and natural resources. In doing so, the Foundation has remained true to its founder's philosophy of promoting "the social betterment of mankind."

Sponsored Event:

2019 Annual Conference

PLATINUM SPONSORS

University of Pittsburgh, The Graduate School of Public and International Affairs



The Graduate School of Public and International Affairs (GSPIA) at the University of Pittsburgh is one of the world's most comprehensive schools of public and international affairs. GSPIA offers graduate degrees in public administration, public and international affairs and international development; a mid-career master's degree in public policy and management (available online or on campus); and a doctorate in public and international affairs. Through quality teaching, experiential learning and rigorous research, as well as an emphasis on ethical leadership, GSPIA prepares and empowers leaders interested in working on local issues and those with global interests. Its MPA, MPIA and MID programs are accredited by the Network of Schools of Public Policy, Affairs, and Administration (NASPAA).

Sponsored Events/Items:

**Donald C. Stone Lecture
Name Badge Holder**

Virginia Commonwealth University, L. Douglas Wilder School of Government and Public Affairs



The L. Douglas Wilder School of Government and Public Affairs at Virginia Commonwealth University in Richmond, Virginia, informs public policy through scholarship and community engagement and prepares students to be tomorrow's leaders. The Wilder School embodies the values of independent thought and public service championed by L. Douglas Wilder, the nation's

CONFERENCE SPONSORS

first elected African American governor and a distinguished professor at the school that bears his name. We offer graduate and undergraduate degrees and certificates in public policy administration, criminal justice, homeland security and emergency preparedness, urban and regional studies and planning, nonprofit management, geographic information systems and gender violence intervention. The Wilder School's centers provide expertise in research, leadership development and policy outreach. The Wilder School's Master of Public Administration program seeks to develop creative, principled leaders who understand the demands placed on local, national and global public and nonprofit institutions and are equipped with skills in program management and policy analysis. Applying theory and practice, the program addresses complex social problems while advancing collaborative, effective, equitable and ethical democratic governance. The Wilder School is blocks from the Virginia Capitol and a two-hour drive from the nation's capital, making it an ideal location for hands-on learning in governance and public policy.

Sponsored Events/Items:

**Social Equity Track
Conference Tote Bag**

GOLD SPONSOR

George Mason University, Schar School of Policy and Government

George Mason University's Schar School of Policy and Government prepares students to be leaders and managers who solve problems and advance public good in all sectors and levels of government—in the United States and around the world. Located where policy happens—just miles from the Pentagon, the White House and the U.S. Capitol—students are connected to jobs, internships, networking and experiences that can only be found in the Washington, DC area. It is policy in action. Learning from professors with real-world experience, students gain the applicable skills and practical knowledge to lead government agencies and nonprofit organizations, develop public policies and programs, create innovative consulting solutions or provide expert policy analysis. Graduates and faculty are doing consequential work at the U.S. Department of State, USAID, the World Bank, the United Nations, the National Endowment for Democracy, Deloitte, Booz Allen Hamilton and many others.



Sponsored Item:

Wireless Internet in Meeting Space

University of Delaware, Biden School of Public Policy and Administration



UNIVERSITY OF DELAWARE
BIDEN SCHOOL OF PUBLIC
POLICY & ADMINISTRATION

The Joseph R. Biden, Jr. School of Public Policy and Administration at the University of Delaware is a globally recognized, interdisciplinary and comprehensive school of public affairs. The Biden School houses eight graduate degree programs in public administration, public policy research, urban affairs, disaster science and management and energy and environmental policy; three undergraduate majors and four minors in public policy, organizational and community leadership, energy and environmental policy, and public health; two graduate certificates; and five research and public service centers. The Biden School engages in sponsored and unsponsored research and policy analysis and also provides technical assistance to a wide range of governmental, nonprofit and community institutions. Through its academic programs and research and public service centers, the Biden School engages faculty, professional research staff and students from a variety of disciplines and diverse backgrounds in the classroom, on public service projects and in collaboration with outside organizations. The Biden School translates scholarship and research into usable knowledge that informs decisionmaking and policy, improves leadership and management, and addresses the critical needs of our times.

Sponsored Event:

Closing Plenary

SILVER SPONSORS

Deloitte

Deloitte's Government and Public Services practice—our people, ideas, technology and outcomes—are designed for impact. Our team of more than 12,000 professionals across the country bring fresh perspective to help you anticipate disruption, reimagine the possible and fulfill your mission promise. Whether you are at the crossroads of AI and workforce transformation, cyber and IT modernization or digital and citizen experience, we bring actionable insights to drive bold and lasting results. Our shared purpose and passion help you make an impact and improve the lives of citizens.

Sponsored Events:

Presidential Panel: "Significant Risks in Higher Education—The Future Is In Our Hands"

Presidential Panel: "The Buck Stops Here: How Federal Leaders Can Reduce Improper Payments"

Deloitte.

CONFERENCE SPONSORS

Ohio State University, John Glenn College of Public Affairs

The John Glenn College of Public Affairs at The Ohio State University is committed to inspiring and developing the next generation of public and nonprofit professionals who can handle complex issues and make change a reality in civic life. The Glenn College is ranked as the best in Ohio and 18th nationally among the 272 public affairs graduate schools in the 2018 *U.S. News & World Report* ratings. The college teaches its students how governments, nonprofits and private firms can work together to serve the public and get results. Through internships, service opportunities and collaborations with community partners, Glenn College students go beyond the classroom to tackle real-world issues that demand new approaches.



Sponsored Event:
Elliot Richardson Lecture

Texas A&M University, Bush School of Government and Public Service

The Bush School of Government and Public Service opened its doors on the Texas A&M University campus in 1997. The university's service and leadership ideals, which reflect those of our namesake, George H.W. Bush, are a guiding force in our instruction. The Bush School offers residential master's degrees in public service and administration, international affairs, and a new online executive Master of Public Service and Administration degree. Graduate certificates in advanced international affairs, nonprofit management and homeland security also are available online. Through these programs, the Bush School provides a high quality and affordable education to more than 600 students who desire careers in public and international affairs at local, state, national and international levels.



Sponsored Item:
Hotel Key Cards

BRONZE SPONSORS

California State University—San Bernardino

The Master of Public Administration at California State University—San Bernardino (CSUSB) prepares students for leadership in public service. Our mission is to offer a high quality education in public administration founded on public service values, especially diversity, inclusiveness and democratic governance. We provide students with



a generalist public administration education, including tools for decisionmaking, an understanding of the democratic system of governance in the United States and a capacity to work ethically and professionally in the public interest. We are committed to ethical practices in public management and support ASPA's Code of Ethics. The MPA at CSUSB is offered through both on-campus and online classes. All classes are offered each year in both formats so students can choose the modality that fits their life and learning style.

Sponsored Item:
Lanyards

Tarleton State University

The Master of Public Administration (MPA) program at Tarleton State University aims to provide students with the skills and knowledge they need to direct programs and implement policies related to Public Administration. In both face-to-face and online instruction, we deliver a solid foundation and vast understanding of budgeting, management, policy/law and legal processes through coursework and hands-on experiences. We are dedicated to equipping our students with an extensive background in a wide range of topics and disciplines related to the public sector. The MPA at Tarleton State University is designed to maximize each student's potential, while educating students with an exciting, interactive and rewarding course of study.



Sponsored Item:
Luggage Tags

University of San Francisco, School of Management

The University of San Francisco's (USF) Master of Public Administration provides students with first-hand experience in public management throughout the Bay Area and beyond. Students gain graduate-level skills in policy, program evaluation, management and best practices for designing sustainable communities. The program is offered in person and online, with an optional concentration in health care services administration, preparing students to succeed in the full range of public sector, nonprofit and health care organizations. USF's MPA was ranked in the top third of Best Public Affairs Programs in the U.S. by the *U.S. News & World Report*.



Sponsored Item:
Charging Station

CONFERENCE SPONSORS

University of Southern California, Sol Price School of Public Policy



Answering a call from public officials, the University of Southern California (USC) Sol Price School of Public Policy opened its doors in 1929, becoming the second school of its kind in the nation. Today, the Price School remains a leading academic institution in 21st century research and education. In 2019, we celebrate nine decades of forging solutions toward a resilient and just world. Our three pillars—governance, urban development and policy—cut across 16 interdisciplinary research centers and six primary fields of study: public management, public policy, nonprofit leadership, health policy and management, urban planning and real estate development. Our graduates pioneer solutions to challenges facing communities worldwide and the research of our more than 200 faculty is cited by elected officials at all levels. Ranked second among 282 schools of public affairs nationwide, the Price School is ambitious to carry our legacy forward into the next decade and beyond.

Sponsored Item:
Hand Sanitizer

COPPER SPONSORS

Cleveland State University, Maxine Goodman Levin College of Urban Affairs (*Welcome Reception*)
Penn State Harrisburg (*Name Badges*)
Sacred Heart University (*Awards Brochure*)
Southeastern Conference for Public Administration (SECoPA) (*Welcome Reception*)

UNIVERSITY OF KANSAS SCHOOL of PUBLIC AFFAIRS *and* ADMINISTRATION

*Congratulates Rosemary O'Leary as the winner of the SWPA 2019
Rita Mae Kelly Distinguished Research Award*

ROSEMARY O'LEARY



Director, Edwin O. Stene Distinguished Professor

ALFRED TAT KEI HO



Professor;
ASPA National Council Member (2015-2018); Kansas ASPA Chapter Executive Officer

H. GEORGE FREDERICKSON



Edwin O. Stene Distinguished Professor Emeritus;
ASPA President (1977-78)

HEATHER GETHA-TAYLOR



Associate Professor;
Editor-in-Chief, *Personnel Management Journal* (SPLAR); Kansas ASPA Chapter Advisory Board Member

HANNES ZACHARIAS



Professor of Practice in City Management;
Kansas ASPA Outstanding Public Service Leader of the Year, 2018



FOUNDERS' FELLOWS SUPPORTERS

Thank you to the following individuals and organizations whose generous support makes the Founders' Fellows program a success.

Full

ASPA Section on Personnel Administration and Labor Relations
Brigham Young University

Merit

Centro de Investigación y Docencia Económicas, A.C. (CIDE)
Public Administration Quarterly
Southeastern Conference for Public Administration (SECoPA)
University of Texas at Dallas

Book

ASPA Association for Budgeting and Financial Management
ASPA Evergreen Chapter
ASPA Massachusetts Chapter
ASPA North Texas Chapter
ASPA Section on Emergency and Crisis Management
ASPA South Florida Chapter
ASPA Southern California Chapter
ASPA Students and New Administration Professionals Section
Louisiana State University
Midwest Public Affairs Conference (MPAC)
Mississippi State University

Contributor

ASPA LGBT Advocacy Alliance
ASPA New Jersey Chapter
ASPA Suncoast Chapter
J. Paul Blake
Michael Brintnall
Paul Danczyk
Mehmet Demircioglu
Janice Lachance
Grant Rissler
Stephen Rolandi
Allan Rosenbaum
Kendra Stewart
Loretta Tillery
Shilpa Viswanath
Aziza Zemrani

GET YOUR MASTER OF PUBLIC ADMINISTRATION

TSU
TEXAS SOUTHERN UNIVERSITY
Barbara Jordan - Mickey Leland
School of Public Affairs
MPA and EMPA Programs



**EDUCATION FOR PUBLIC LEADERS ...
THE PEOPLE WHO MAKE A DIFFERENCE.**

MPA
Offered to meet the demands of mid-career professionals around the globe.
48 hours in just 24 months of full time study advances your career to the next level.

EMPA
Offered online to meet the demands of mid-career in service professionals and military personnel.
36 hours in just 16 months of full time study advances your career to the next level.

www.tsu.edu | 713.313.7760

Conference Registration

ASPAs registration desk is in Promenade Foyer. Registration badges and other conference materials can be picked up there. The registration desk will be open at the following times:

Thursday, March 7	2:00 p.m. – 5:00 p.m.
Friday, March 8	7:00 a.m. – 5:00 p.m.
Saturday, March 9	7:00 a.m. – 6:00 p.m.
Sunday, March 10	7:00 a.m. – 6:00 p.m.
Monday, March 11	7:00 a.m. – 6:00 p.m.
Tuesday, March 12	7:00 a.m. – 10:30 a.m.

Badges

All conference registrants will receive a personalized badge with their registration packet. **This badge must be worn at all times and will be checked at all sessions, meal functions and events.** If you misplace your badge, please come to the ASPA registration desk in the Promenade Foyer for a replacement.

Security Reminder, Cell Phones and Other Electronic Devices

Please be courteous to presenters and fellow attendees by silencing your cell phone or other electronic devices while attending educational sessions and meetings. Attendees are reminded not to leave items of value, including laptops, purses and tablets, unattended at any time. **Neither the hotel nor ASPA is responsible for lost or stolen items.**

Continuing Education

Attendees who seek continuing education can request a self-report form at the registration desk. Forms must be completed by the attendee and submitted to the individual professional association, academic institution, licensing board or agency for consideration. ASPA does not notify organizations on behalf of attendees, nor does it keep session attendance records. ASPA cannot guarantee acceptance for continuing education by individual licensing boards. Questions regarding continuing education can be sent to aspaconference@aspanet.org.

Speaker Cancellations/Substitutions

ASPAs makes every effort to offer programs of the highest caliber. In the event of speaker/author cancellation, ASPA reserves the right to modify session material or substitute speakers without advance notice.

Special Assistance

ASPAs is committed to making its entire conference accessible to all individuals, including those with disabilities. For further information regarding special needs, or if you have previously requested assistance, please stop by the ASPA registration desk.

Connect with Us!

Make the most of our social media channels throughout the conference. Share your experience and hear the buzz from others!



@ASPANational – and tweet about the conference using #ASPAs2019



ASPANational

Annual Conference Website:

www.aspanet.org/conference2019

ASPAs Is Eco-Friendly!

ASPAs recognizes the importance of protecting the environment and “green” meeting practices. We have eliminated paper copies of presentation abstracts and conference addenda. Panel updates and changes will be made daily and posted on the Annual Conference website, www.aspanet.org/conference2019.



INSPIRING LEADERS TO ADVANCE THE COMMON GOOD

Ranked among the country's top 10 professional public policy and planning schools, the Humphrey School of Public Affairs at the University of Minnesota is widely recognized for its role in examining public issues and shaping policy and planning at the local, state, national, and international levels.

- » Six Master's Degrees
- » PhD in Public Affairs
- » Six Certificates

INNOVATIVE, ONLINE TOOLS SHARE RESEARCH WITH PUBLIC

In 2018, the Humphrey School launched an online collection of multimedia projects designed to share faculty's research findings with policymakers and community partners in engaging and accessible ways.

The collection, called Civios, currently features more than 40 podcasts, videos, and mixed media presentations on issues ranging from immigration to sex trafficking and climate change. New products are uploaded regularly, and then shared with practitioners and the broader public through social networks.

Check out the research at civios.umn.edu.

FACULTY NEWS



DANIEL CHENG

Associate Professor

Cheng joined the Humphrey School last year after completing a PhD and serving as a Visiting Assistant Professor at Indiana University. He researches questions surrounding governance, government-nonprofit relationships, co-production, and cross-sector collaboration, often with a focus on urban sustainability. Recent work examines the processes and consequences of nonprofits becoming important players in determining and financing public service provision.



KATHY QUICK

Associate Professor

Quick's research focuses on practices and processes for involving diverse stakeholders in policy-making to address complex public problems, particularly the role of public and nonprofit managers and agencies in public engagement. Research policy areas include urban planning, transportation safety and infrastructure policy, community-police relations, and environmental management.



JERRY ZHAO

Associate Professor

Zhao serves as the Director of Graduate Studies for the Master of Public Policy (MPP) program. He also directs the Institute for Urban & Regional Infrastructure Finance to advance research and engagement on strategic issues of infrastructure investment across urban and rural areas. In ASPA, Zhao chairs the Section on Chinese Public Administration (SCPA), and he is just elected to serve on ASPA's National Council, representing District IV.

HOTEL FLOOR PLAN



LOBBY

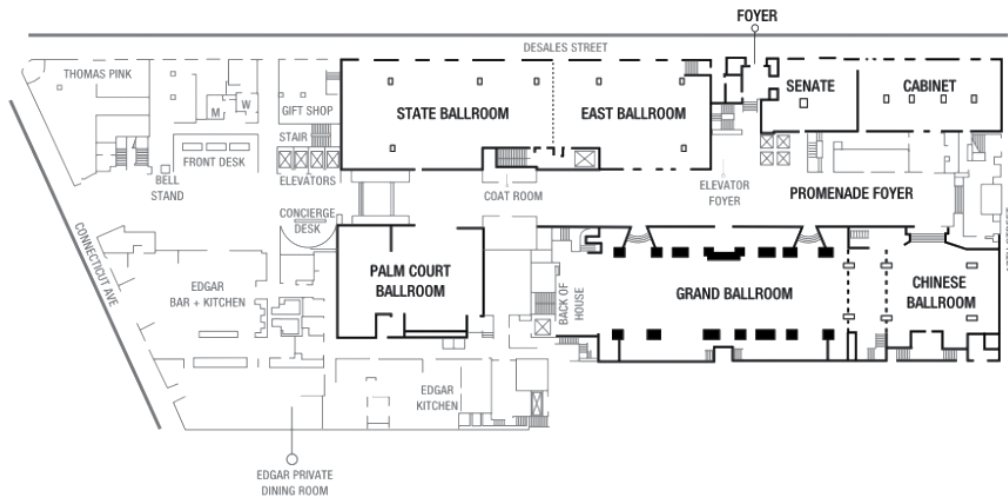

LOWER LEVEL

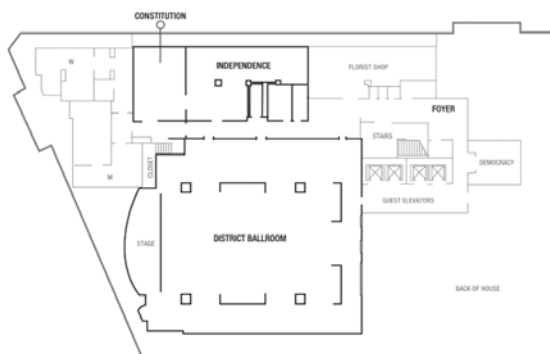

SECOND LEVEL

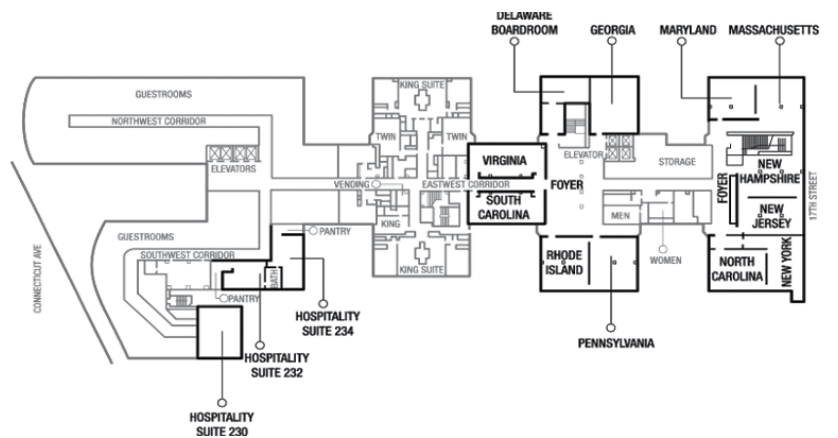

CONFERENCE AT A GLANCE

Chapter, Section and Journal meetings are listed on p. 18.

THURSDAY MARCH 7

Registration Open	2:00 p.m. - 5:00 p.m.	Promenade Foyer
-------------------	-----------------------	-----------------

FRIDAY MARCH 8

Focusing on Public Service, Global Public Administration and Public Finance

Registration Open	7:00 a.m. - 5:00 p.m.	Promenade Foyer
Presidential Panel (<i>Global Public Administration Focus</i>)	8:00 a.m. - 9:15 a.m.	Chinese Ballroom
Panel Sessions	8:00 a.m. - 9:15 a.m.	Various Locations
Student and New Professional Summit	8:00 a.m. - 3:15 p.m.	Palm Court Ballroom
Fred Riggs Symposium	8:00 a.m. - 6:45 p.m.	Maryland and New Hampshire
Deil S. Wright Symposium	8:45 a.m. - 4:30 p.m.	Pennsylvania
Endowment Board Meeting	9:00 a.m. - 11:30 a.m.	Democracy
Presidential Panel (<i>Public Service Focus</i>)	9:30 a.m. - 10:45 a.m.	Chinese Ballroom
Panel Sessions	9:30 a.m. - 10:45 a.m.	Various Locations
Presidential Panel (<i>Public Service Focus</i>)	11:00 a.m. - 12:30 p.m.	Chinese Ballroom
L. Frances Liddell COMPA Student Policy Debate	12:00 p.m. - 2:00 p.m.	Virginia
Presidential Panel (<i>Public Finance Focus</i>)	12:45 p.m. - 2:00 p.m.	Chinese Ballroom
Panel Sessions	12:45 p.m. - 2:00 p.m.	Various Locations
National Council Meeting	1:00 p.m. - 3:00 p.m.	South Carolina
Presidential Panel (<i>Public Service Focus</i>)	2:15 p.m. - 3:30 p.m.	Chinese Ballroom
Founders' Fellows Panel	2:15 p.m. - 3:30 p.m.	Virginia
Panel Sessions	2:15 p.m. - 3:30 p.m.	Various Locations
Presidential Panel (<i>Public Service Focus</i>)	3:45 p.m. - 5:00 p.m.	Chinese Ballroom
Panel Sessions	3:45 p.m. - 5:00 p.m.	Various Locations
Chapter and Section Business Meetings	5:30 p.m. - 6:30 p.m.	Various Locations
Founders' Fellows Orientation and Welcome Reception	6:30 p.m. - 7:30 p.m.	Senate

SATURDAY MARCH 9

Focusing on Public Service, Global Public Administration and Public Finance

Registration Open	7:00 a.m. - 6:00 p.m.	Promenade Foyer
Chapter and Section Business Meetings	7:30 a.m. - 8:45 a.m.	Various Locations
Opening Plenary	9:00 a.m. - 10:30 a.m.	Grand Ballroom
Presidential Panel (<i>Public Service Focus</i>)	10:45 a.m. - 12:00 p.m.	Chinese Ballroom
Founders' Fellows Panel	10:45 a.m. - 12:00 p.m.	Virginia
Panel Sessions	10:45 a.m. - 12:00 p.m.	Various Locations
Marc Holzer Public Performance Symposium	10:45 a.m. - 3:00 p.m.	North Carolina
Presidential Panel (<i>Global Public Administration Focus</i>)	12:15 p.m. - 1:30 p.m.	Chinese Ballroom
Chapter Leadership Meeting	12:15 p.m. - 1:30 p.m.	Independence
Panel Sessions	12:15 p.m. - 1:30 p.m.	Various Locations
Past Presidents' Luncheon (<i>Ticketed Event</i>)	12:15 p.m. - 2:00 p.m.	District Ballroom
Exhibit Hall Open	12:30 p.m. - 6:30 p.m.	State and East Rooms
Presidential Panel (<i>Public Finance Focus</i>)	1:45 p.m. - 3:00 p.m.	Chinese Ballroom
Section Leadership Meeting	3:15 p.m. - 4:30 p.m.	Independence
Panel Sessions	3:15 p.m. - 4:30 p.m.	Various Locations
Social Equity, Diversity and Inclusion Workshop	4:00 p.m. - 7:00 p.m.	Chinese Ballroom
Panel Sessions	4:45 p.m. - 6:00 p.m.	Various Locations
Welcome Reception	6:30 p.m. - 8:30 p.m.	Grand Ballroom

CONFERENCE AT A GLANCE

SUNDAY MARCH 10

Focusing on Public Service, Global Public Administration, Infrastructure and Social Equity

Registration Open	7:00 a.m. – 6:00 p.m.	Promenade Foyer
Chapter and Section Business Meetings	7:00 a.m. – 8:15 a.m.	Various Locations
Presidential Panel (<i>Infrastructure Focus</i>)	8:30 a.m. – 9:45 a.m.	Chinese Ballroom
Panel Sessions	8:30 a.m. – 9:45 a.m.	Various Locations
Exhibit Hall Open	9:00 a.m. – 7:00 p.m.	State and East Rooms
Elliot Richardson Lecture	10:00 a.m. – 11:30 a.m.	Grand Ballroom
Gloria Hobson Nordin Social Equity Luncheon (<i>Ticketed Event</i>)	11:45 a.m. – 1:00 p.m.	District Ballroom
Presidential Panel (<i>Public Service Focus</i>)	11:45 a.m. – 1:00 p.m.	Chinese Ballroom
Panel Sessions	11:45 a.m. – 1:00 p.m.	Various Locations
Public Service Plenary	1:30 p.m. – 3:00 p.m.	Grand Ballroom
Presidential Panel (<i>Social Equity Focus</i>)	3:15 p.m. – 4:30 p.m.	Chinese Ballroom
Founders' Fellows Panel	3:15 p.m. – 4:30 p.m.	Virginia
Panel Sessions	3:15 p.m. – 4:30 p.m.	Various Locations
Global Public Administration Plenary and International Assembly	4:30 p.m. – 6:30 p.m.	Grand Ballroom
Chapter and Section Business Meetings	4:45 p.m. – 6:00 p.m.	Various Locations
Wiley Exhibit Hall Reception	6:00 p.m. – 7:00 p.m.	State and East Rooms
Networking and University Receptions	6:30 p.m. – 7:30 p.m.	Various Locations

MONDAY MARCH 11

Focusing on Public Service, Global Public Administration, Infrastructure and Social Equity

Registration Open	7:00 a.m. – 6:00 p.m.	Promenade Foyer
Section for Women in Public Administration National Awards Breakfast (<i>Ticketed Event</i>)	7:45 a.m. – 9:15 a.m.	District Ballroom
Presidential Panel (<i>Infrastructure Focus</i>)	8:00 a.m. – 9:15 a.m.	Chinese Ballroom
Panel Sessions	8:00 a.m. – 9:15 a.m.	Various Locations
Exhibit Hall Open	9:00 a.m. – 3:00 p.m.	State and East Rooms
Donald C. Stone Lecture	9:30 a.m. – 11:00 a.m.	Grand Ballroom
Presidential Panel (<i>Social Equity Focus</i>)	11:15 a.m. – 12:30 p.m.	Chinese Ballroom
Founders' Fellows Panel	11:15 a.m. – 12:30 p.m.	Virginia
Panel Sessions	11:15 a.m. – 12:30 p.m.	Various Locations
Presidential Panel (<i>Infrastructure Focus</i>)	12:45 p.m. – 2:00 p.m.	Chinese Ballroom
Panel Sessions	12:45 p.m. – 2:00 p.m.	Various Locations
Presidential Panel (<i>Social Equity Focus</i>)	2:15 p.m. – 3:30 p.m.	Chinese Ballroom
Presidential Panel (<i>Public Service Focus</i>)	3:45 p.m. – 5:00 p.m.	Chinese Ballroom
Panel Sessions	3:45 p.m. – 5:00 p.m.	Various Locations
Chapter and Section Business Meetings	5:30 p.m. – 6:30 p.m.	Various Locations
Networking and University Receptions	6:30 p.m. – 7:30 p.m.	Various Locations

TUESDAY MARCH 12

Focusing on Public Service, Global Public Administration, Social Equity

Registration Open	7:00 a.m. – 10:30 a.m.	Promenade Foyer
Presidential Panel (<i>Public Finance Focus</i>)	8:00 a.m. – 9:15 a.m.	Chinese Ballroom
Panel Sessions	8:00 a.m. – 9:15 a.m.	Various Locations
Panel Sessions	9:30 a.m. – 10:45 a.m.	Various Locations
Closing Plenary	11:00 a.m. – 1:00 p.m.	Grand Ballroom

CHAPTER, SECTION, JOURNAL MEETINGS

FRIDAY MARCH 8

National Capital Area Chapter (NCAC) Flash Mentoring Event	4:30 p.m. - 6:30 p.m.	Palm Court Ballroom
Conference of Minority Public Administrators (COMPA)	5:30 p.m. - 6:30 p.m.	Virginia
<i>Public Performance Management Review (PPMR)</i> Journal Editors Meeting	5:30 p.m. - 6:30 p.m.	North Carolina
Section for Women in Public Administration (SWPA)	5:30 p.m. - 6:30 p.m.	New York
Section on Public Administration Education (SPAEE)	5:30 p.m. - 6:30 p.m.	Massachusetts
Section on Ethics and Integrity of Governance (SEIGOV) and <i>Public Integrity</i> Journal Editors Meeting	5:30 p.m. - 7:00 p.m.	New Jersey
Section on Intergovernmental Administration and Management (SIAM)	5:30 p.m. - 7:00 p.m.	Pennsylvania
Section on Historical, Artistic and Reflective Expression (SHARE) and <i>Public Voices</i> Journal Editors Meeting	6:30 p.m. - 7:30 p.m.	South Carolina

SATURDAY MARCH 9

<i>American Review of Public Administration (ARPA)</i> Journal Editors Meeting	7:30 a.m. - 8:45 a.m.	Maryland
Center for Accountability and Performance Business Meeting and Emerging Leaders Presentations	7:30 a.m. - 8:45 a.m.	South Carolina
International Chapter	7:30 a.m. - 8:45 a.m.	Massachusetts
<i>International Journal of Public Administration (IJPA)</i> Editors Meeting	7:30 a.m. - 8:45 a.m.	Rhode Island
Northeast Conference on Public Administration (NECOPA) and New York Metropolitan Chapter	7:30 a.m. - 8:45 a.m.	Pennsylvania
Section on Chinese Public Administration (SCPA)	7:30 a.m. - 8:45 a.m.	Virginia
Section on Complexity and Network Studies (SCNS)	7:30 a.m. - 8:45 a.m.	New Hampshire
Section on International and Comparative Administration (SICA)	7:30 a.m. - 8:45 a.m.	New York
Section on Public Administration Research (SPAR)	7:30 a.m. - 8:45 a.m.	North Carolina
Students and New Administration Professionals Section (SNAPS)	7:30 a.m. - 8:45 a.m.	New Jersey
Chapter Leadership Meeting	12:15 p.m. - 1:30 p.m.	Independence
Section Leadership Meeting	3:15 p.m. - 4:30 p.m.	Independence

SUNDAY MARCH 10

Alabama Chapter	7:00 a.m. - 8:15 a.m.	New York
<i>Public Administration Review (PAR)</i> Editorial Board Meeting	7:00 a.m. - 8:15 a.m.	Virginia
Section on African Public Administration (SAPA)	7:00 a.m. - 8:15 a.m.	Maryland
Section on Chinese Public Administration (SCPA) Deans' Roundtable	7:00 a.m. - 8:15 a.m.	Rhode Island
Section on Democracy and Social Justice (SDSJ)	7:00 a.m. - 8:15 a.m.	Massachusetts
Section on Nonprofit Policy, Practice and Partnerships (SNPPP)	7:00 a.m. - 8:15 a.m.	North Carolina
Section on Personnel Administration and Labor Relations (SPALR)	7:00 a.m. - 8:15 a.m.	New Jersey
Section on Public Performance and Management (SPPM)	7:00 a.m. - 8:15 a.m.	New Hampshire
Section on Science and Technology in Government (SSTIG)	7:00 a.m. - 8:15 a.m.	Pennsylvania
<i>Chinese Public Administration Review (CPAR)</i> Journal Editors Meeting	4:45 p.m. - 6:00 p.m.	Pennsylvania
LGBT Advocacy Alliance (LGBT)	4:45 p.m. - 6:00 p.m.	Maryland
Section on Effective and Sound Administration in the Middle East (SESAME)	4:45 p.m. - 6:00 p.m.	New York
Section on Environmental and Natural Resources Administration (SENRA)	4:45 p.m. - 6:00 p.m.	Constitution
Section on Health and Human Services Administration (SHHSA)	4:45 p.m. - 6:00 p.m.	New Jersey
Section on Korean Public Administration (SKPA)	4:45 p.m. - 6:00 p.m.	Independence
Section on Procurement and Contract Management (SPCM)	4:45 p.m. - 6:00 p.m.	New Hampshire
Section on Transportation Policy and Administration (STPA)	4:45 p.m. - 6:00 p.m.	North Carolina

MONDAY MARCH 11

Section on Professional and Organizational Development (SPOD)	5:30 p.m. - 6:30 p.m.	New Hampshire
Section on Public Law and Administration (SPLA)	5:30 p.m. - 6:30 p.m.	Maryland

A GUIDE TO THE 2019 ANNUAL CONFERENCE TRACKS

ASPA's 2019 Annual Conference features a more targeted, focused conference experience, looking at five critical areas of public administration: global public administration, infrastructure, public finance, public service and social equity.

To help you better decide which panels to attend, you will find that panel details throughout the book are color-coded based on the track and grouped together for ease of reading.

● Global Public Administration

The globe may be large, but the public administration world is more inextricably linked than ever before. Actions in nation-states can directly, often quickly, affect policy and administration in others. As important, one nation's experiences can inform others, providing best practices that bridge the geographic divide and can be applied in a global context. Panels will address public administration from an international perspective.

● Infrastructure

In the United States and beyond, public infrastructure faces an uphill battle. Examples include crumbling bricks-and-mortar bridges and highways, crowded transportation systems, underdeveloped cyber infrastructure and waterways fraught with health and transportation concerns. Addressing the infrastructure challenge requires foreseeing an infrastructure for the future. How will we pay for it and how will we manage it? These panels will address critical, practical concerns that affect all of us, every day.

● Public Finance

No matter the public program or service, government must be able to pay for it. Operating in an environment where uncertainty is the norm, predictability can be finance's best friend. What tools can finance and budget offices use to identify and address problems before they happen, make fiscally responsible decisions and operate effectively? These panels will help advance a greater understanding of the public finance role and challenges associated.

● Public Service

Public service is a bold and noble profession, but one too often subject to demoralizing commentary and pejorative characterization. In the meantime, the rules and practices under which civil servants operate—from recruitment to retention, engagement to training—are drawing heightened attention with an eye toward putting best practices and reform into action. Panels will highlight what is working well at all levels of public service.

Track Sponsored By:



● Social Equity

Equity, or a lack thereof, underpins government's most important work. Public servants should be treated in an equitable fashion and the services they provide must be equitable as well. Infrastructure must be equitable to enable success for all populations. Government budgeting and finance must be equitable to enable public works to serve all people. Further, we must understand ways to measure the success and impact of equity in public programs. These panels will shape our understanding of these issues and showcase programs done well.

Track Sponsored By:



ASPA SECTIONS

Membership in an ASPA Section is open to every member. Sections are a meaningful way to gain indispensable knowledge and forge lasting connections in specialized areas, meet peers and network. To add a Section to your membership, please email membership@aspanet.org.

Association for Budgeting and Financial Management.....	ABFM
Center for Accountability and Performance*.....	CAP
Conference of Minority Public Administrators.....	COMPA
LGBT Advocacy Alliance	LGBT
Section for Women in Public Administration	SWPA
Section on African Public Administration.....	SAPA
Section on Chinese Public Administration.....	SCPA
Section on Complexity and Network Studies	SCNS
Section on Criminal Justice Administration	SCJA
Section on Democracy and Social Justice.....	SDSJ
Section on Effective and Sound Administration in the Middle East.....	SESAME
Section on Emergency and Crisis Management	SECM
Section on Environmental and Natural Resources Administration	SENRA
Section on Ethics and Integrity in Governance.....	SEIGOV
Section on Health and Human Services Administration	SHHSA
Section on Historic, Artistic and Reflective Expression.....	SHARE
Section on Intergovernmental Administration and Management	SIAM
Section on International and Comparative Administration.....	SICA
Section on Korean Public Administration	SKPA
Section on Nonprofit Policy, Practice and Partnerships	SNPPP
Section on Personnel Administration and Labor Relations.....	SPALR
Section on Procurement and Contract Management.....	SPCM
Section on Professional and Organizational Development	SPOD
Section on Public Administration Education.....	SPAE
Section on Public Administration Research	SPAR
Section on Public Law and Administration.....	SPLA
Section on Public Management Practice	SPMP
Section on Public Performance and Management	SPPM
Section on Science and Technology in Government.....	SSTG
Section on Transportation Policy and Administration	STPA
Students and New Administration Professionals Section	SNAPS

**CAP is not an ASPA Section, but a center within ASPA that encourages the use of performance measurement and managing for results in the public sector.*

ASPA PAST PRESIDENTS

William Mosher	1939-40	Patrick J. Conklin.....	1980-81
Harold D. Smith.....	1940-41	Chester A. Newland	1981-82
Louis Brownlow.....	1941-44	A. Lee Fritschler	1982-83
Luther H. Gulick.....	1944-46	Patricia S. Florestano	1983-84
Charles S. Ascher.....	1946-47	Bradley H. Patterson, Jr.	1984-85
Leonard D. White.....	1947-48	Naomi B. Lynn	1985-86
John J. Corson	1948-49	Sylvester Murray.....	1986-87
Roscoe C. Martin.....	1949-50	Robert B. Denhardt.....	1987-88
Donald C. Stone.....	1950-51	Charlotte O. Gray.....	1988-89
John M. Gaus	1951-52	Morris W. H. Collins, Jr.	1989-90
James M. Mitchell	1952-53	Carl W. Stenberg	1990-91
John A. Perkins.....	1953-54	Enid Beaumont.....	1991-92
William W. Parsons	1954-55	Thomas D. Lynch.....	1992-93
Gordon R. Clapp.....	1955-56	Christine Gibbs Springer	1993-94
Matthias E. Lukens	1956-57	Robert H. McClain, Jr.	1994-95
Henry Reining, Jr.	1957-58	Edward T. Jennings, Jr.	1995-96
John W. Macy.....	1958-59	Yong Hyo Cho.....	1996-97
G. Homer Durham	1959-60	Mary Ellen Guy.....	1997-98
John D. Millett.....	1960-61	Todd W. Argow.....	1998-99
Elmer B. Staats.....	1961-62	Anne M. Swafford	1999-2000
Stephen B. Sweeney.....	1962-63	Marc Holzer	2000-01
York Wilbern.....	1963-64	F. Daniel Ahern, Jr.	2001-02
Harvey Sherman.....	1964-65	Glen Hahn Cope	2002-03
Lloyd M. Short	1965-66	Walter D. Broadnax	2003-04
James E. Webb	1966-67	Cheryle A. Broom	2004-05
Stephen K. Bailey.....	1967-68	Donald C. Menzel	2005-06
James A. Norton	1968-69	Wendy A. Haynes.....	2006-07
Ferrel Heady.....	1969-70	Harvey L. White	2007-08
Harlan Cleveland	1970-71	Donald E. Klingner.....	2008-09
Walter W. Mode.....	1971-72	Paul Posner.....	2009-10
John W. Ryan.....	1972-73	Meredith A. Newman	2010-11
Frank P. Sherwood.....	1973-74	Erik O. Bergrud	2011-12
Philip J. Rutledge.....	1974-75	Kuotsai Tom Liou	2012-13
Randy H. Hamilton	1975-76	Stephen E. Condrey	2013-14
Nesta M. Gallas	1976-77	Allan Rosenbaum.....	2014-15
H. George Frederickson	1977-78	Maria P. Aristigueta	2015-16
Dwight A. Ink.....	1978-79	Susan T. Gooden	2016-17
Raymond Remy	1979-80	Janice Lachance.....	2017-18

2019 EXHIBIT HALL

The Exhibit Hall is located in State and East Ballrooms.

Exhibit Hall Sponsored By:



Exhibit Hall Schedule

Take advantage of our Exhibit Hall where you can network, meet this year's exhibiting organizations, meet new friends, reconnect with longstanding ones and learn about new products and services.

Saturday, March 9	12:30 p.m. – 6:30 p.m.
Sunday, March 10	9:00 a.m. – 7:00 p.m.
Monday, March 11	9:00 a.m. – 3:00 p.m.

Exhibit Hall Activities

Saturday Coffee Break	3:15 p.m. – 4:00 p.m.
Sunday Coffee Break	9:30 a.m. – 10:15 a.m.
Monday Coffee Break	9:30 a.m. – 10:15 a.m.

Book Signings

Publishers' book signings are scheduled on Sunday, March 10 from 11:30 a.m. – 3:30 p.m.

Ambassador Christopher Hill will be signing copies of his memoir, *Outpost—Life on the Frontlines of American Diplomacy*, on Sunday, March 10 at 5:30 p.m.

Public Administration Review Reception

6:00 p.m. – 7:00 p.m. on Sunday, March 10.

Reception Sponsored By: **WILEY**

Exhibit Hall Floor Plan

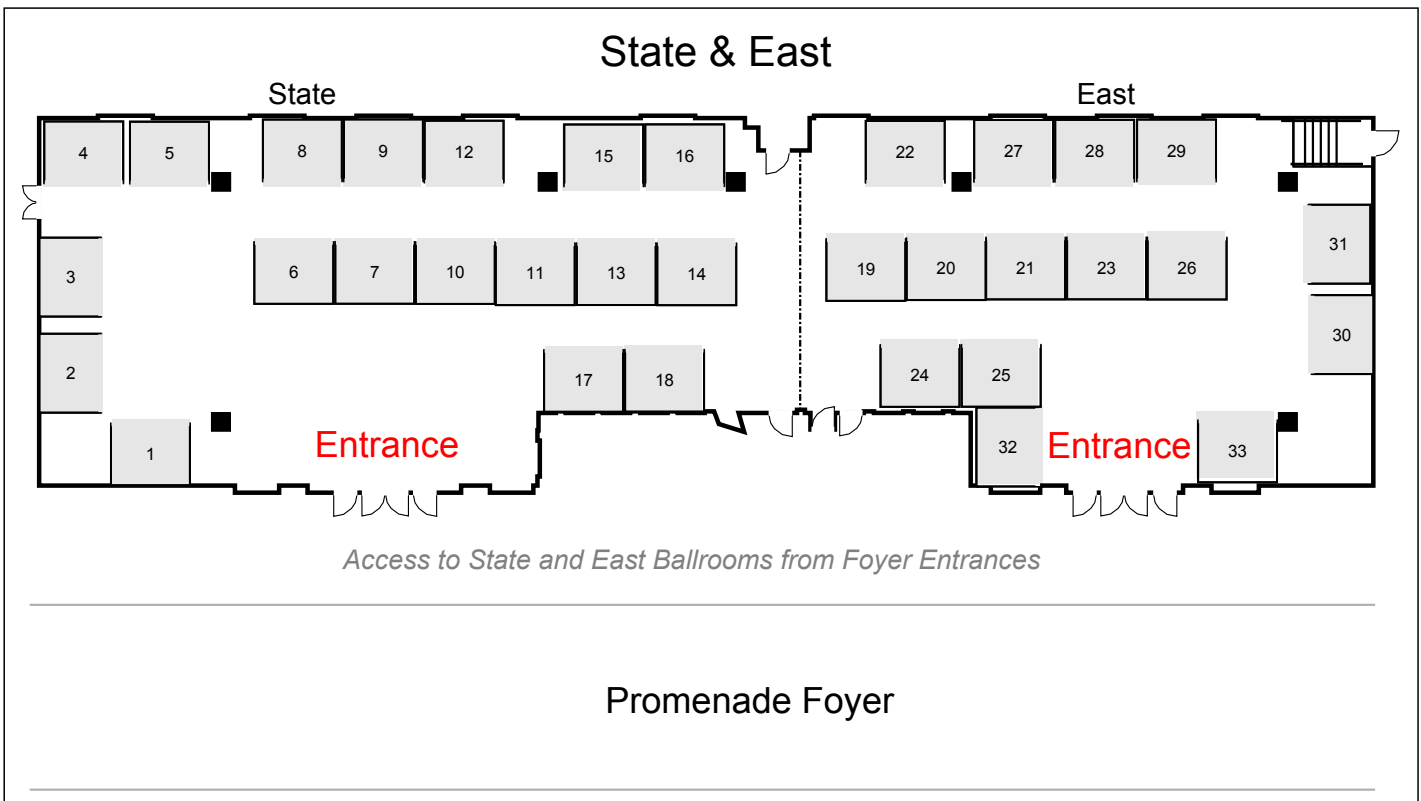

Exhibitors by Alphabetical Order

American Society for Public Administration	33
American University..... Promenade Foyer	
Birkdale Publishers	21
Carl Vinson Institute of Government, University of Georgia.....	30
George Mason University, Schar School.....	23
Georgetown University, McCourt School	2
GovLoop	15
GSPIA, University of Pittsburgh	32
Institute for Public Service/Suffolk University–Boston.....	14
Melvin & Leigh Publishers.....	18
National Forum for Black Public Administrators	22
National University of Singapore, Lee Kuan Yew School of Public Policy	13
Northeast Conference of Public Administration	16
NIGP: The Institute for Public Procurement	11
Pennsylvania State University–World Campus.....	26
Rowman & Littlefield.....	7
Rutgers University–Camden.....	17
Rutgers University–Newark	6
Section for Women in Public Administration (SWPA).....	20
Southeast Conference for Public Administration (SECoPA).....	5
Springer Nature	24, 25
Sun Yat-sen University	10
Taylor and Francis	8, 9, 12
University of Chicago	19
University of Delaware	1
L. Douglas Wilder School, Virginia Commonwealth University	31
Wiley.....	3

Exhibitors by Number

University of Delaware	1
American University..... Promenade Foyer	
Georgetown University, McCourt School	2
Wiley.....	3
Southeast Conference for Public Administration (SECoPA).....	5
Rutgers University–Newark	6
Rowman & Littlefield.....	7
Taylor and Francis	8, 9, 12
Sun Yat-sen University	10
NIGP: The Institute for Public Procurement	11
National University of Singapore, Lee Kuan Yew School of Public Policy	13
Institute for Public Service/Suffolk University–Boston.....	14
GovLoop	15
Northeast Conference of Public Administration	16
Rutgers University–Camden.....	17
Melvin & Leigh Publishers.....	18
University of Chicago	19
Section for Women in Public Administration (SWPA).....	20
Birkdale Publishers	21
National Forum for Black Public Administrators	22
George Mason University, Schar School.....	23
Springer Nature	24, 25
Pennsylvania State University–World Campus.....	26
Carl Vinson Institute of Government, University of Georgia.....	30
L. Douglas Wilder School, Virginia Commonwealth University	31
GSPIA, University of Pittsburgh	32
American Society for Public Administration	33



Portland State
Hatfield School of Government

Join In

Engage Portland. Engage the world.

Ph.D. in Public Affairs and Policy

Master of Public Policy

MA/MS in Political Science

Master of Public Administration

Master of Public Administration: *Health Administration*

Graduate Certificate in Collaborative Governance

Graduate Certificate in Nonprofit Management

www.pdx.edu/hatfieldschool

PLENARIES & LECTURES

Opening Plenary	25
Elliot Richardson Lecture.....	28
Gloria Hobson Nordin Social Equity Award Luncheon	29
Public Service Plenary.....	30
Global Public Administration Plenary and International Assembly	31
Section for Women in Public Administration Breakfast.....	32
Donald C. Stone Lecture.....	33
Closing Plenary.....	34



Harry S Truman School of Public Affairs

University of Missouri

Welcomes new faculty!

**Sarah Beth
Kitch**

PhD, Louisiana
State University
Assistant Professor
Public Service,
Ethics & Democracy



Brian Kisida

PhD, University of
Arkansas
Assistant Professor
Program Evaluation
Policy Analysis
Education Policy

David Switzer

PhD, Texas A&M
Assistant Professor
Public Management
Environmental
Policy



Weijie Wang

PhD, USC
Collaborative
Governance,
Strategic Human
Resource
Management

Oded Gurantz

PhD, Stanford
Assistant Professor
Economics of
Education
Education Policy
Higher Education



**Nationally-accredited
Master of Public Affairs with Emphases in:**

Public Policy

Public Management

Nonprofit Management

Offered on-campus and online!

PhD Program

Interdisciplinary Education

Cutting-edge Scholarship

Outstanding Faculty

... Also Check Out Our

12-Credit Hour

Graduate Certificates!

Truman.Missouri.edu

SATURDAY, MARCH 9, 2019

9:00 a.m. – 10:30 a.m.

Grand Ballroom

Jane Pisano



Jane Pisano is professor in the University of Southern California (USC) Sol Price School of Public Policy. Her areas of expertise include nonprofit leadership and management, public administration, public-private partnerships and civic engagement.

Pisano served as president and director of the Natural History Museum of Los Angeles County from 2001 to 2015. Her top priorities were to focus on the museum visitor's experience by transforming the institution into a 21st century destination. She supported innovative programming, strengthened the scientific program and built partnerships that positioned the museum as a hub for public dialogue.

Pisano joined USC in 1991 as dean of the School of Public Administration. During her nearly seven-year tenure, she led a major effort to strengthen the school academically at both the graduate and undergraduate levels. In 1994, Pisano was appointed vice president of external relations at the university and was promoted to senior vice president in 1998. She also developed a community outreach program that was nationally recognized when USC was named Time magazine College of the Year in 2000. She conceptualized and implemented the Good Neighbors campaign to fund university/neighborhood partnerships for neighborhood improvement.

Pisano earned master's and doctorate degrees in international relations from the Johns Hopkins University School of Advanced International Studies, and her bachelor's degree from Stanford University.

Paul Danczyk



Paul Danczyk is director of executive education in Sacramento for the University of Southern California Sol Price School of Public Policy. In this role, he designs, coordinates and presents in leadership and management programs reaching national, state and local governments and nonprofit organizations. Over the

past five years, Danczyk expanded programmatic collaborations through a portfolio totaling more than \$1 million annually. As an executive coach, he worked one-on-one with more than 400 public sector senior executives and administrators. He is cofounder and lead architect of www.LeadershipEnergizes.com, a 360-degree leadership assessment for executives and emerging leaders. He also teaches master-level classes in California and, previously, Mexico.

With the National Council's support and guidance and as 2019-2020 president, Danczyk's vision expands ASPA's impacts in unison with Chapters and Sections through targeted programming culminating toward the ASPA annual conference, *2020 Vision for Politics, Policy, and Administration*, which will take place in Anaheim, California April 3-7, 2020. This approach builds on significant leadership and staff efforts delivering a robust webinar series, expanding member relationships and benefits, and strengthening strategic organizational partnerships that extend well beyond sponsorship opportunities.

A returned Peace Corps Volunteer, Danczyk earned his PhD from the University of Pittsburgh, focusing on Public and International Affairs; a Master of Public Administration from the University of Southern California; and a Bachelor of Science in Education from The Pennsylvania State University. He is a professional certified coach through the International Coaching Federation, trained at the Hudson Institute for Coaching, and he holds certifications from Harvard University's Mediating Disputes Program and Barrett's Values Centre.

An ongoing student of the arts and sciences, Danczyk enjoys landscaping, creating sculptures, painting, and bee keeping.

OPENING PLENARY

PUBLIC FINANCE LECTURER

Anthony A. Williams



Tony Williams, the former mayor of Washington, DC (1999-2007), is chief executive officer of the Federal City Council, an organization focusing the creative and administrative talents of Washington's business and professional leaders on major problems and opportunities facing

the District.

Williams is widely credited with leading Washington's comeback during his two terms as mayor, restoring our nation's capital's finances and improving the performance of government agencies, all while lowering taxes and investing in infrastructure and human services.

In addition to his duties with the Federal City Council, Williams is a senior advisor to King and Spaulding, LLP

and serves on several company boards, as well as the boards of Urban Institute and the National Geographic Society. Prior to Federal City Council, he led the global government practice at the Corporate Executive Board in Arlington, Virginia. He also taught public finance and urban leadership as the William H. Bloomberg lecturer in public management at Harvard's John F. Kennedy School of Government, while coordinating programs for the Municipal Innovation Program at the Ash Center for Democratic Governance and Innovation.

Williams holds a bachelor's degree from Yale, a master's degree from the Harvard Kennedy School and a J.D. from Harvard Law School, as well as a number of awards and honorary degrees, including *Governing Magazine* Public Official of the Year in 1997. He is a National Academy of Public Administration fellow and former president of the National League of Cities.



CSIS Headquarters

D.C.-based Executive MAIR

Move Forward

*Midcareer degrees from America's #1 graduate program in public leadership and management **



In Washington

Executive MA in International Relations

For midcareer professionals looking to advance their careers and deepen their understanding of critical global issues. Classes held at the **Center for Strategic and International Studies**.

Online

ExecutiveMPA@Syracuse

Prepares experienced public servants to advance within government, nonprofit, and for-profit organizations. Students meet online to collaborate on public service issues they face in their communities.



Online MPA

On Campus

Executive MPA, MAIR, and joint MPA/IR

Prepares managers for the challenges of leading organizations in the public and private sectors in the midst of dynamic global change — midcareer versions of Maxwell's famous professional degrees.

Maxwell | **Syracuse University**

Maxwell School of Citizenship and Public Affairs
215 Eggers Hall | Syracuse, NY 13244 | 315.443.4000

maxwell.syr.edu/paia

* U.S. News & World Report's
2019 Best Grad Schools



ELLIOT RICHARDSON LECTURE

SUNDAY, MARCH 10, 2019

10:00 a.m. – 11:30 a.m.

Grand Ballroom

Session Sponsored By:



LECTURER

Jack Knott



Jack Knott is the dean and C. Erwin and Ione L. Piper Chair and Professor of the Sol Price School of Public Policy at the University of Southern California. He has led the school in this role since 2005. He is a leading scholar in the fields of political institutions and public policy and is a past president of the

Network of Schools of Public Policy, Affairs and Administration (NASPAA), the international association of schools of public affairs. He has published three books, including *Reforming Bureaucracy: The Politics of Institutional Choice*, and numerous journal articles and book chapters. In addition, he has earned fellowships from the Russell Sage Foundation and the International Institute of Management in Berlin, and has served as a consultant to the W.K. Kellogg Foundation.

Dean Knott will be joined by an esteemed group of panelists to discuss public administration and democracy, and the importance each of these topics plays with the other.

PANELISTS

Paul C. Light



Paul C. Light is a professor of public service at New York University. He is the director of studies at the National Academy of Public Administration, a senior advisor to Sen. John Glenn (D-OH) and vice president for governmental studies at the Brookings Institution. He is the author of *The Government-Industrial Complex: Tracking the True Size of Government, 1984-2018*.

Shelley Metzenbaum



Shelley Metzenbaum works to bring about a better world through better government, working both within and outside government. As founder of The BETTER Project, she encourages governments and those funded or regulated by government to use goals, data, analysis, well-designed trials, incentives and visualization to find ways to improve outcomes and other aspects of performance, and to avoid using these tools in ways that create fear and dysfunctional responses. Metzenbaum previously served as founding president of the Volcker Alliance, associate director for performance and personnel management at the U.S. Office of Management and Budget, head of regional operations at the U.S. Environmental Protection Agency, and undersecretary of environmental affairs and director of capital budgeting for the Commonwealth of Massachusetts. She holds a doctorate in public policy from the Harvard Kennedy School and a bachelor's degree in humanities and Asian studies.

Awards Presented

John W. Gaston Award

Elmer B. Staats Lifetime Achievement Award

GLORIA HOBSON NORDIN SOCIAL EQUITY AWARD LUNCHEON

SUNDAY, MARCH 10, 2019
11:45 a.m. – 1:00 p.m.
District Ballroom

Brandi Blessett



Brandi Blessett is associate professor and director of the master of public administration program at the University of Cincinnati. Her research focuses on administrative responsibility, disenfranchisement and social equity. These interests offer insight regarding the effects of

institutional and systemic injustice and their contemporary implications for urban communities and their residents.

Blessett serves as book and film review editor for *Public Integrity* and as associate editor for *Administrative Theory & Praxis*. She has published in peer-reviewed periodicals, including *Administration & Society*, *Administrative Theory & Praxis*, *Public Administration Quarterly*, *Public Integrity* and the *Journal of*

Health and Human Services Administration. She also has contributed book chapters to *Teaching the Wire: Frameworks, Theories and Strategies for the Classroom*, *Prison Privatization: The Many Facets of a Controversial Industry*, *Contemporary Perspectives on Affirmative Action*, and *Leadership and Change in Public Organization: Beyond Reform*.

Blessett earned a bachelor of science from the University of Michigan in Ann Arbor and holds a master in educational leadership from Wayne State University in Detroit. After teaching as a high school health and life skills teacher at Highland Park Community High School, she decided to pursue her doctorate at Old Dominion University. Her dissertation was titled “Dispersion or Re-Segregation: A Spatial and Temporal Analysis of Public Policies and Their Impact on Urban African American Mobility.” This work serves as the foundation for her research interests.

Awards Presented

Gloria Hobson Nordin Social Equity Award

Equal Opportunity/Affirmative Action
Exemplary Practice Award

PUBLIC SERVICE PLENARY

SUNDAY, MARCH 10, 2019

1:30 p.m. – 3:00 p.m.

Grand Ballroom

PANELISTS

Mary Guy



Mary Guy is professor of public administration in the School of Public Affairs at the University of Colorado Denver. Her research and teaching interests focus on the human processes involved in public service delivery. She currently leads a team of researchers who are investigating

the everyday work experience of public servants around the globe. Guy is a fellow of the National Academy of Public Administration, past president of ASPA and past editor in chief of the *Review of Public Personnel Administration*.

Patricia Shields



Patricia Shields is currently a professor at Texas State University. Her research interests include the application of the philosophy of pragmatism to the field of public administration. She found Jane Addams as a recently recovered founder of classical pragmatism and democratic theorist. Following

her dissertation research, which looked at the equity of the military recruitment process during the Vietnam era, she has studied civil/military relations. In 2001, Shields became editor-in-chief of *Armed Forces & Society*, a top 10 military studies journal. Addams' role as leader of the women's peace movement led to the Nobel Peace Prize; her three books about peace were less well known. Recognizing this omission, Shields investigated Addams' ideas of peace, seeing applications for contemporary peacekeeping operations and within public administration itself. Shields has won *Public Administration Review's* Laverne Burchfield Award, the Section for Women in Public Administration's Rita Mae Kelly Research Award for Outstanding Research in Gender Related Issues and NASPAA's Leslie A. Whittington Excellence in Teaching Award.

Awards Presented

Public Integrity Award

Paul P. Van Riper Award for Excellence and Service

GLOBAL PUBLIC ADMINISTRATION PLENARY AND INTERNATIONAL ASSEMBLY

SUNDAY, MARCH 10, 2019
4:30 p.m. – 6:30 p.m.
Grand Ballroom

Christopher Hill



Ambassador Christopher Hill is chief advisor to the chancellor for global engagement and professor of the practice in diplomacy at the University of Denver. Prior to this position, he was dean of the Josef Korbel School of International Studies at the university, a position he held from September

2010-December 2017.

Prior to serving in academia, Hill was a career diplomat and four-time ambassador, nominated by three presidents, whose most recent post was as ambassador to Iraq (2009-2010). Prior to Iraq, Hill served as assistant secretary of state for East Asian and Pacific Affairs from 2005-2009, during which he was the head of the United States delegation to the “six party talks” regarding North Korea’s nuclear armaments. Earlier, he was U.S. ambassador to the Republic of Korea. Previously he served as ambassador to Poland (2000-2004), ambassador to the Republic of Macedonia (1996-1999)

and special envoy to Kosovo (1998-1999). He also served as a special assistant to the president and a senior director on the staff of the National Security Council (1999-2000).

Earlier in his Foreign Service career, Hill served tours in Belgrade, Warsaw, Seoul and Tirana, and on the Department of State’s policy planning staff and in the department’s operation center. While on a fellowship with the American Political Science Association, he served as a staff member for Congressman Stephen Solarz working on Eastern European issues. He also served as the Department of State’s senior country officer for Poland. Hill received the department’s Distinguished Service Award for his contributions as a member of the United States negotiating team in the Bosnia peace settlement and was a recipient of the Robert S. Frasure Award for Peace Negotiations for his work on the Kosovo crisis.

Hill graduated from Bowdoin College in Brunswick, Maine with a BA; he received a master’s degree from the Naval War College in 1994. He speaks Polish, Serbo-Croatian and Macedonian.

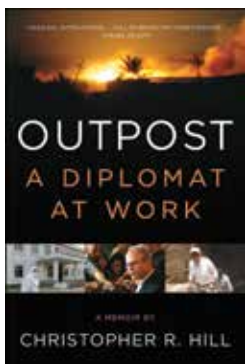

Ambassador Hill will sign copies of his memoir, *Outpost—Life on the Frontlines of American Diplomacy: A Memoir*, following his remarks. The signing will take place in the Exhibit Hall (State and East Rooms) starting at 5:30 p.m. Thanks to KramerBooks for supporting this booksigning event.

Awards Presented

H. George Frederickson *PA TIMES* Best Article Award

International Public Administration Award

SECTION FOR WOMEN IN PUBLIC ADMINISTRATION NATIONAL AWARDS BREAKFAST

MONDAY, MARCH 11, 2019
7:45 a.m. – 9:15 a.m.
District Ballroom

Breakfast Sponsored By:



Susan T. Gooden



Susan T. Gooden is interim dean and professor of the L. Douglas Wilder School of Government and Public Affairs at Virginia Commonwealth University. She is an internationally recognized expert on social equity, an elected fellow of the National Academy of Public Administration and past president of the American

Society for Public Administration. Her books include *Why Research Methods Matter* (2018, Melvin and Leigh), *Race and Social Equity: A Nervous Area of Government* (2014, Routledge) and *Cultural Competency for Public Administrators* (2012, Routledge). Her research has been funded by several organizations, including the Russell

Sage Foundation, the W. K. Kellogg Foundation, the Smith Richardson Foundation, MDRC and the Manhattan Institute for Policy Research.

Gooden was appointed to the Commission on Peer Review and Accreditation, the accrediting arm of the Network of Associated Schools of Public Policy, Affairs and Administration (NASPAA). She previously has served as an elected member to the national policy council of the Association for Public Policy Analysis and Management. In 2016, she was appointed to the Virginia Community College System board by Governor Terence McAuliffe.

Gooden earned her bachelor's degree from Virginia Tech, her master's degree from Virginia Tech and her doctorate from the Maxwell School of Citizenship and Public Affairs at Syracuse University.

Awards Presented

Joan Fiss Bishop Leadership Award

Julia J. Henderson International Award

Marcia P. "Marcy" Crowley Service to SWPA Award

Rita Mae Kelly Distinguished Research Award

MONDAY, MARCH 11, 2019

9:30 a.m. – 11:00 a.m.

Grand Ballroom

Session Sponsored By:



Sylvia M. Burwell



Sylvia M. Burwell is American University's 15th president and the first woman to serve as president. A visionary leader with experience in the public and private sectors, President Burwell brings to American University a commitment to education and research, the ability to manage

large and complex organizations, and experience helping to advance solutions to some of the world's most pressing challenges.

Burwell has held two cabinet positions in the United States government. She served as the 22nd secretary of the US Department of Health and Human Services from 2014 to 2017. During her tenure, she managed a trillion-dollar department that includes the National Institutes of Health, Centers for Disease Control and Prevention, Food and Drug Administration, and the Medicaid and Medicare programs; oversaw the successful implementation of the Affordable Care Act; and led the department's responses to the Ebola and Zika outbreaks. Before that, she served as the director of the Office of Management and Budget, working with Congress to negotiate a two-year budget deal following the 2013 government shutdown. In both roles she was known as a leader who worked successfully across the aisle and focused on delivering results for the American people.

Her additional government experience is extensive and includes roles as deputy director of the Office of Management and Budget, deputy chief of staff to the president, chief of staff to the secretary of the Treasury, and special assistant to the director of the National Economic Council.

Burwell has held leadership positions at two of the largest foundations in the world. She served 11 years at the Bill and Melinda Gates Foundation, including roles as the chief operating officer and president of the Global Development Program. She then served as president of the Walmart Foundation and ran its global Women's Economic Empowerment efforts. Her private sector experience includes service on the Board of Directors of MetLife.

She earned a bachelor's degree in Government from Harvard University and a BA in Philosophy, Policy and Economics from the University of Oxford as a Rhodes Scholar.

A second-generation Greek American, Burwell is a native of Hinton, West Virginia. She and her husband Stephen Burwell are the parents of two young children.

Awards Presented

National Public Service Awards

Donald C. Stone Service to ASPA Award

Dwight Waldo Award

Public Administration Review Awards

Louis Brownlow Award

Laverne Burchfield Award

William E. Mosher and Frederick C. Mosher Award

Chester Newland Award

CLOSING PLENARY

TUESDAY, MARCH 12, 2019

11:00 a.m. – 1:00 p.m.

Grand Ballroom

Plenary Sponsored By:



UNIVERSITY OF DELAWARE
BIDEN SCHOOL OF PUBLIC
POLICY & ADMINISTRATION

Joseph R. Biden, Jr.



Joseph Robinette Biden, Jr. represented Delaware for 36 years in the U.S. Senate before becoming the 47th Vice President of the United States.

Joseph Robinette Biden, Jr., was born November 20, 1942, in Scranton, Pennsylvania, the first of four siblings. In 1953, the Biden

family moved from Pennsylvania to Claymont, Delaware. He graduated from the University of Delaware and Syracuse Law School and served on the New Castle County Council. Then, at age 29, he became one of the youngest people ever elected to the United States Senate.

Just weeks after the election, tragedy struck the Biden family when then Senator-elect Biden's wife, Neilia, and their one-year-old daughter, Naomi, died and his 2 sons were injured in an auto accident. Vice President Biden was sworn into the U.S. Senate at his sons' hospital bedside and began commuting to Washington every day by train, a practice he maintained throughout his career in the Senate.

In 1977, Vice President Biden married Jill Jacobs. Jill Biden, who holds a Doctorate in Education, is a life-long educator and currently teaches at a community college in Northern Virginia. The Vice President's son, Beau, was Delaware's Attorney General from 2007-2015 and a Major in the 261st Signal Brigade of the Delaware National Guard. He was deployed to Iraq in 2008-2009. Beau passed away in 2015 after battling brain cancer with the same integrity, courage, and strength he demonstrated every day of his life. The Vice President's second son, Hunter, is an attorney who manages a private equity firm in Washington, D.C. His daughter Ashley is a social worker and Executive Director of the Delaware Center for Justice. Vice President Biden has five grandchildren: Naomi, Finnegan, Roberta Mabel ("Maisy"), Natalie, and Robert Hunter.

As a Senator from Delaware for 36 years, Vice President Biden established himself as a leader in facing some of our nation's most important domestic and international challenges. As Chairman or Ranking Member of the Senate Judiciary Committee for 17 years, then-Senator Biden was widely recognized for his work on criminal justice issues, including the landmark 1994 Crime Act and the Violence Against Women Act. As Chairman or Ranking Member of the Senate Foreign Relations Committee for 12 years, then-Senator Biden played a pivotal role in shaping U.S. foreign

policy. He has been at the forefront of issues and legislation related to terrorism, weapons of mass destruction, post-Cold War Europe, the Middle East, and Southwest Asia.

As the 47th Vice President of the United States, Joe Biden continued his leadership on important issues facing the nation and represented America abroad, traveling over 1.2 million miles to more than 50 countries. Vice President Biden convened sessions of the President's Cabinet, led interagency efforts, and worked with Congress in his fight to raise the living standards of middle class Americans, reduce gun violence, and address violence against women. In the final year of the Administration, Vice President Biden led the Cancer Moonshot, an international effort to end cancer as we know it.

Since leaving the White House in January 2017, Vice President Biden has continued his legacy of expanding opportunity for all, both in the United States and abroad, with the creation of the Biden Foundation, the Penn Biden Center for Diplomacy and Global Engagement at the University of Pennsylvania, the Biden Cancer Initiative, and the Biden Institute at the University of Delaware. Through these non-profit organizations, Vice President Biden and Dr. Biden are developing programs designed to advance smart policies, convene experts and world leaders on the issues they care most about, and impact the national debate about how America can continue to lead in the 21st century. In addition, Vice President Biden formed a political action committee, "American Possibilities," which will allow him to continue to support Democratic candidates and causes across the country.

Finally, in November 2017, Vice President Biden released his second book, *Promise Me, Dad: A Year of Hope, Hardship, and Purpose*. The book, a *New York Times* #1 Bestseller, is a personal story from a father, grandfather, husband, and friend as he confronts the inevitability of devastating personal loss, while trying to balance his duty to his family and his country.

He has received numerous awards and accolades, including the National Civil Rights Museum's Freedom Award and the Medal of Freedom with Distinction.

In December of 2018, the University of Delaware named its school of public policy the Joseph R. Biden, Jr. School of Public Policy and Administration.



SCHOOL OF
**PUBLIC AND
ENVIRONMENTAL AFFAIRS**
Indiana University

SPEA celebrates the distinguished career of and the outstanding contributions to the professional literature of public administration by:



Lisa Blomgren Amsler

Keller-Runden Professor of Public Service
2019 recipient of the Dwight Waldo Award

SPEA's research and teaching faculty of more than 190 includes these public management and leadership scholars:



Claudia Avellaneda



Michael McGuire



Sean Nicholson-Crotty



Jim Perry



Amanda Rutherford

**BEST
GRAD SCHOOLS**

U.S. News & WORLD REPORT

PUBLIC AFFAIRS

2019



UNIVERSITY OF NEBRASKA AT OMAHA

SCHOOL OF PUBLIC ADMINISTRATION



Nuriel Heckler
Assistant Professor

Administrative Law, Nonprofit,
Social Equity



Trang T. Hoang
Assistant Professor

Public and Nonprofit Budgeting,
Financial Management

**The School
of Public
Administration
at the University
of Nebraska at
Omaha is proud
to introduce our
newest faculty
members.**

Welcome to UNO!

spa.unomaha.edu | 402.554.2625 | facebook.com/unospa

UNIVERSITY OF
Nebraska
Omaha



The University of Nebraska does not discriminate based on race, color, ethnicity, national origin, sex, pregnancy, sexual orientation, gender identity, religion, disability, age, genetic information, veteran status, marital status, and/or political affiliation in its programs, activities, or employment.

SPECIAL EVENTS & ACTIVITIES

Presidential Panels	37
Partner Organization Sessions	58
Welcome Reception.....	59
Student and New Professional Summit.....	60
Founders' Fellows Reception.....	63
Founders' Fellows Panels	64
National Public Service Awards	65
2019 Society Awards	68
Section Awards	70
Networking Events.....	74

#ASPA2019

• NEWLY NAMED •

Joseph R. Biden, Jr. School of Public Policy & Administration

WELCOMES **NEW FACULTY**



**Gregory
Dobler**

Assistant Professor

Data science to
explore urban
communities

**Federica
Bianco**

Assistant Professor

Data science,
urban science,
prosecutorial
justice

**Katie
Fitzpatrick**

Associate Professor

Financial policies
for low-income
households

**Kalim
Shah**

Assistant Professor

Environmental
policy

**Casey
Taylor**

Assistant Professor

Wildlife
management
policy

**Stephen
Metraux**

Associate Professor

Housing,
homelessness,
and mental health

Educating future leaders in public affairs through our world-class programs, including the MPA and a new MPP, with a focus on real-world experiential learning. Areas of study include:

Nonprofit Management — Public Management — Public Policy Analysis

Emergency Management — Public Finance & Budgeting — Energy & Environmental Policy

Disaster Science & Management — Urban Affairs & Public Policy

Offering graduate certificate programs in Historic Preservation and Nonprofit and Voluntary Action.



UNIVERSITY OF DELAWARE
BIDEN SCHOOL OF PUBLIC
POLICY & ADMINISTRATION



@UDBidenSchool

bidenschool.udel.edu

Public Administration Advancing Rule-Ordered Institutions in Asia

FRIDAY, MARCH 8

8:00 a.m. - 9:15 a.m.

Chinese Ballroom

Global Public Administration

This panel will discuss the role of public administration in developing and advancing rule-ordered institutions. Panelists will draw on decades of experience and research in Asia to provide their insights on the design of public institutions, drawing in part on the work of Elinor Ostrom on rule development for effective cooperation. Speakers also will look at specific examples from several nations when discussing the challenges and successes.

Moderator

Marilyn Rubin



Marilyn Rubin is distinguished research fellow in the School of Public Affairs and Administration at Rutgers—Newark. She also is professor emerita of public administration and economics and former director of the MPA program at John Jay College of the City University of New York. She

has more than 35 years of experience working as a consultant and advisor to high-level government officials in the United States and abroad on projects related to fiscal policy, economic development and strategic planning, and has been a member of economic advisory boards to elected officials at the federal, state and local levels. Rubin is a National Academy of Public Administration fellow and has been a member of editorial boards for *Public Administration Review* and *Public Budgeting and Finance*. She has edited books and book chapters and published articles in many professional journals, and served as a visiting professor at universities outside the United States, including Xiamen University, Jiangxi University and Sun Yat Sen University in China. She has been a Fulbright senior specialist program advisor in Ecuador and Brazil.

Presenters

M. Jae Moon



M. Jae Moon serves on the faculty in the Department of Public Administration and as director of the Institute for Future Government at Yonsei University, South Korea. His research interests include public management, information technology, e-government and comparative

public administration. He is a National Academy of Public Administration fellow and served as ASPA's international director and vice president of the Korean Association of Public Administration in 2017. His work on e-government was selected as one of the 15 most influential pieces published in *Public Administration Review (PAR)*. Moon was recipient of the Mosher Award for the best article published in *PAR* and the Peter Boorsma Award for International Scholar in 2009. He was selected as one of world's 100 most influential people in Digital Government 2018 by Apolitical, a London-based leading nonprofit organization.

Shui-Yan Tang



Shui-Yan Tang is Duggan professor in public administration at the Sol Price School of Public Policy, University of Southern California. He also is a National Academy of Public Administration fellow.

Kaifeng Yang



Kaifeng Yang is professor in the Askew School of Public Administration and Policy, Florida International University, and dean and professor in the School of Public Administration and Policy, Renmin University of China. He has published widely on public management, performance

management and citizen participation.

PRESIDENTIAL PANELS

Data Analytics

FRIDAY, MARCH 8

9:30 a.m. - 10:45 a.m.

Chinese Ballroom

Public Service

Achieving agencies' vital missions, including tackling complex national challenges and threats, requires a focus on learning and continuous improvement. A key improvement strategy is using data and evidence to learn and do what works—and adjust what does not. At a time when technology allows for the collection, combination and analysis of vast reams of data and government prepares for the automation of much of its administrative daily work, government leaders must challenge themselves to think through ways to harness these new capacities to ensure programs effectively achieve the outcomes our country needs. During this panel, you will hear from select agencies about practices that enable them to leverage data in making important decisions and improving program management and performance.

Moderator

Mallory Bulman



Mallory Barg Bulman leads the Partnership for Public Service's research and evaluation portfolios. She is responsible for strengthening the evidence that the Partnership uses to hold government leaders accountable and identifying innovation and best practices across government.

She also is responsible for assessing the impact of the Partnership's programs and supporting its continuous improvement. Bulman has more than a decade of experience using data and insights to drive change in government.

Presenter

Andrew Feldman



Andrew Feldman is director in the public sector practice at Grant Thornton. His work focuses on helping public sector organizations use evidence, data and innovation to better achieve their missions. He also hosts the Gov Innovator podcast, with more than 160 interviews for results-focused

leaders. His prior positions include visiting fellow at the Center for Children and Families at the Brookings Institution, special adviser on the evidence team at the

White House Office of Management and Budget in the Obama administration, one of the top three appointed leaders in Wisconsin's labor department, senior policy adviser in the Office of Wisconsin Gov. Jim Doyle, staff economist at the White House Council of Economic Advisers in the Clinton administration and special assistant to the president at MDRC, a social policy research firm. He earned his undergraduate degree from Swarthmore College and his master's degree and doctorate in public policy from Harvard University. He is a National Academy of Public Administration fellow.

Revitalizing the Middle Class: Workforce Issues

FRIDAY, MARCH 8

11:00 a.m. - 12:30 p.m.

Chinese Ballroom

Public Service

Of the many challenges our country faces, the instability of the middle class is one that could yield the most dramatic consequences for our nation if not effectively addressed. Vice President Biden and his institute at the University of Delaware have set out to tackle this issue head-on, calling it "the great challenge of our time." This panel, organized in conjunction with the Biden Institute and its expert economists, demographers and other consultants, will focus on workforce issues affecting the middle class, including income inequality, defining the poverty line, transportation equity, health and child care challenges. The panel is a continuation of discussions that the institute has been having with public administrators and academics over the past 18 months. Be in the audience to share your voice as we continue generating ideas the vice president and policymakers can put to use to revitalize our middle class.

Moderator

Maria Aristigueta



Maria Aristigueta is director of the Biden School of Public Policy and Administration at the University of Delaware. Her teaching and research interests are in creating strong institutions to strengthen democracy, particularly as it pertains to organizational behavior and performance management.

She serves on the NASPAA Executive Council, and is an ASPA past president and National Academy of Public Administration fellow. She has published numerous journal articles, book chapters and books, including

Managing for Results in State Government; Managing Human Behavior in Public and Nonprofit Organizations (co-author), *Managing and Measuring Performance in Public and Nonprofit Organizations*, and *Organizational Behavior*; she is co-editor of the *International Handbook of Practice-Based Performance Management*. Her doctorate is from the University of Southern California.

Presenters

Heather Boushey



Heather Boushey is executive director and chief economist at the Washington Center for Equitable Growth and co-editor of “After Piketty: The Agenda for Economics and Inequality,” a volume of 22 essays about how to integrate inequality into economic thinking. Her research focuses on economic

inequality and public policy, specifically employment, social policy and family economic well-being. *The New York Times* has called Boushey one of the “most vibrant voices in the field” and *Politico* twice named her one of the top 50 “thinkers, doers and visionaries transforming American politics.” She previously served as chief economist for Hillary Clinton’s transition team and as an economist for the Center for American Progress, the Joint Economic Committee of the U.S. Congress, the Center for Economic and Policy Research and the Economic Policy Institute. Boushey received her doctorate in economics from the New School for Social Research and her bachelor’s degree from Hampshire College.

Stephanie Hoopes



Stephanie Hoopes is director of the ALICE Project, an innovation center for measures in financial hardship. She is the author of *ALICE (Asset-Limited, Income-Constrained, Employed): A Study of Financial Hardship in 18 states*. She was an assistant professor at the School of Public Affairs and

Administration at Rutgers University—Newark and director of Rutgers—Newark’s New Jersey DataBank. Hoopes previously taught at Columbia University in New York and at the Universities of Sussex and Birmingham in the United Kingdom. She has a doctorate from the London School of Economics, a master’s degree from the University of North Carolina at Chapel Hill and a bachelor’s degree from Wellesley College.

Mark Pisano



Mark Pisano is professor of practice at the Sol Price School of Policy, University of Southern California. He also is on the board of the National Academy of Public Administration, co-chairman of the Academy’s Standing Panel on Intergovernmental Relations and co-chairman of the Infrastructure

Working Group of California Forward. From 1976–2008, Pisano directed the activities of the Southern California Association of Governments (SCAG), the nation’s largest regional planning agency that provides an open forum to explore region-wide problems. Prior to joining SCAG, he was director of the Environmental Protection Agency’s water quality planning division where he was responsible for developing policy on implementation of the nation’s water quality management process, including basin and facility planning and wastewater management programs. He also was an economist with the Environmental Protection Agency. Pisano recently published the book, *Puzzle of the American Economy: How Demography is Changing America’s Economy and Politics*.

Leland Ware



Leland Ware is Louis L. Redding professor and chair for the Study of Law and Public Policy at the University of Delaware, a post he has held since 2000. Prior to his present appointment, he was a professor at St. Louis University School of Law from 1987 to 2000 and was a visiting professor at

Boston College Law School in 1992 and Ruhr University in Bochum, Germany in 1997. He was university counsel at Howard University from 1984 to 1987. Ware was a trial attorney with the U.S. Department of Justice Civil Division, in Washington, DC. This research focuses on various aspects of civil rights law; he has authored more than 100 publications consisting of books, academic journal articles, chapters, essays, book reviews, editorials and other publications.

The Buck Stops Here: How Federal Leaders Can Reduce Improper Payments

FRIDAY, MARCH 8

12:45 p.m. - 2:00 p.m.

Chinese Ballroom

Public Finance

In 2017, improper payments totaled more than \$140 billion across the government. Ensuring that taxpayer money is properly spent is a critical function of the government, whether it involves getting the correct benefits to deserving veterans or preventing fraudulent payments to scammers. When agencies mistakenly send payments to people who are not entitled to them or pay incorrect benefit amounts, it is a sign of government ineffectiveness. Utilizing government-wide strategies to reduce improper payments is one piece of the puzzle. Agencies also need to adopt solutions that address root causes of improper payments within their programs. Join this panel discussion about how the federal government can partner with states to improve program integrity. We will look at how using behavioral economics can reduce improper payments, as well.

Moderator

Dave Mader



Dave Mader is chief strategy officer for the civilian sector with Deloitte Consulting LLP in the federal government practice. As a key member of Deloitte's federal leadership team, he shapes and drives the strategy for partnering with civilian government agencies to address complex business

challenges, especially those that require cross-agency collaboration. In this role, he also leads the expansion of Deloitte's shared services offerings, as well as its cross-federal approach to reduce the government's amount of improper payments. Prior to joining Deloitte, Mader served as controller of the Office of Management and Budget and served the Internal Revenue Service for more than 30 years. A longtime leader in the federal government community, he has received numerous awards for his work, sat on key industry boards and published a number of industry-related articles.

Presenters

Cory Baumhardt

Cory Baumhardt is improper payments manager for the U.S. Department of Transportation (DOT) where he is responsible for coordinating DOT's improper payments, enterprise risk management and fraud risk management initiatives. Prior to joining DOT, Baumhardt served as an auditor at the National Institutes of Health, investigating allegations of fraud, waste and abuse, and the Defense Finance and Accounting Service, performing payment recapture audits. He graduated with a bachelor of science and master of business administration from Indiana University.

Donald J. LaVoy

D.J. LaVoy is deputy assistant secretary for the Real Estate Assessment Center (REAC) at the U.S. Department of Housing and Urban Development. He is a retired Marine Officer, Naval Aviator and combat veteran. His professional focus is change management and leading organizations to excellence. LaVoy joined HUD and established REAC in 1998 and, over the course of four years, created the current public housing assessment system and multi-family risk management systems; converted the public housing industry to Generally Accepted Accounting Principles (GAAP); created the property inspection system and protocol; and developed the risk assessment system for single family appraisals. Prior to this role, LaVoy became a HOPE VI grant manager and directed numerous successfully completed housing development projects in New York. He was instrumental in transitioning the Detroit Housing Commission from a failed housing agency to a credible affordable housing provider, among others. He returned to REAC as deputy assistant secretary in 2013 and has focused on a number of areas since that time. He is a graduate of Old Dominion University, the U.S. Army War College and graduated as a military fellow in the Massachusetts Institute of Technology Seminar XXI Program.

Assessing the Trump Administration's Management Agenda: A Media Panel

FRIDAY, MARCH 8

2:15 p.m. - 3:30 p.m.

Chinese Ballroom

Public Service

In this session, a group of reporters and editors from Government Executive Media Group (publishers of *Government Executive*, *Nextgov*, *Defense One* and *Route Fifty*) will discuss the state of management reform efforts in the current administration, including:

- the role of the Office of Management and Budget in crafting and pushing the President's Management Agenda
- how the effort builds on and differs from previous administrations' management improvement efforts
- what the administration is likely to achieve and what will fall by the wayside
- the future of the merit system and civil service rules and regulations
- engaging the federal workforce in reform efforts
- prospects for reform legislation on Capitol Hill in a time of extreme partisanship
- the importance of advanced technology in improving service to citizens

Moderator

Tom Shoop



Tom Shoop is vice president and editor in chief at *Government Executive* Media Group, where he oversees both print and online editorial operations. He started as associate editor of *Government Executive* magazine in 1989; launched the company's flagship website, GovExec.com, in 1996;

and was named editor in chief in 2007.

Presenters

Aaron Boyd



Aaron Boyd is an award-winning journalist serving as senior editor for technology and events at *Nextgov*. He primarily covers federal government IT contracting and cybersecurity issues affecting civilian and defense agencies. A lifelong nerd and policy wonk, he feels right at home covering the

intersection of technology and policy in the nation's capital.

Charles M. Clark



Charles S. Clark joined *Government Executive* in fall 2009. He has been on staff at *The Washington Post*, *Congressional Quarterly*, *National Journal*, *Time-Life Books*, *Tax Analysts*, the Association of Governing Boards of Universities and Colleges and the National Center on Education and

the Economy. He has written or edited online news, daily news stories, long features, wire copy, magazines, books and organizational media strategies.

Eric Katz



Eric Katz writes about federal agency operations and management. His deep coverage of veterans affairs, homeland security, the Environmental Protection Agency and U.S. Postal Service has earned him frequent guest spots on national radio and television news programs. Katz

joined *Government Executive* in summer 2012 and previously worked for *The Financial Times*. He is a graduate of The George Washington University.

Katherine McIntire Peters



Katherine McIntire Peters is deputy editor of *Government Executive* Media Group, a division of Atlantic Media, where she oversees editorial coverage for GovExec.com. She previously was executive editor of *Nextgov*.

PRESIDENTIAL PANELS

The Future Has Begun: Using Artificial Intelligence to Transform Government

FRIDAY, MARCH 8

3:45 p.m. - 5:00 p.m.

Chinese Ballroom

Public Service

In hindsight, it is easy to identify Alexander Graham Bell's invention of the telephone in the 1870s as an instrument of marvel. And, of course, there is the Internet, which few can envision living without despite it being barely 30 years old. Similarly, future historians may look back at this decade as the point at which artificial intelligence (AI) forever changed how the world works, revolutionizing the way we perceive, think, reason, learn and make decisions. More important, AI has the potential to help address many of our country's pervasive problems and advance our well being, as well as transform government. But, it also will change the way public servants do their jobs, and the federal government will have to manage the resulting challenges. This panel will look at this question.

Moderator

Mallory Bulman



Mallory Barg Bulman leads the Partnership for Public Service's research and evaluation portfolios. She is responsible for strengthening the evidence that the Partnership uses to hold government leaders accountable and identifying innovation and best practices across government.

She also is responsible for assessing the impact of the Partnership's programs and supporting its continuous improvement. Bulman has more than a decade of experience using data and insights to drive change in government.

Presenter

Dan Chenok

Dan Chenok is executive director of The IBM Center for The Business of Government, where he oversees all of the center's activities in connecting research to practice to benefit government. He has written and spoken extensively about government technology, cybersecurity, privacy, regulation, budget, acquisition and presidential transitions. Chenok previously led consulting services for public sector technology strategy, working with IBM government, health care and education clients. He serves in numerous industry leadership positions, including a CIO SAGE with the Partnership for Public Service,

National Academy of Public Administration fellow, chair of the cybersecurity subcommittee of the DHS Data Privacy and Integrity Advisory Committee and others. He also advises public sector leaders on a wide range of management issues. He was a senior vice president for civilian operations and was a vice president for business solutions and offerings with SRA International. He earned his bachelor's degree from Columbia University and a master of public policy from Harvard's Kennedy School of Government.

Looking Ahead: What the Public Sector of the Future Must Look Like

SATURDAY, MARCH 9

10:45 a.m. - 12:00 p.m.

Chinese Ballroom

Public Service

It is a challenge that transcends geographic boundaries and levels of government: recruiting and retaining the best and brightest into the public sector. As the traditional definition of "public service" evolves and expands, so too do the skills needed to effectively serve the public good and the expectations governments have of the next generation of public service leaders. And, this transformation is taking place against the backdrop of the ever increasing challenge of inspiring new professionals to join a profession whose work goes unheralded and often unappreciated. What is happening on the front lines of federal, state, county and local governments? A distinguished panel of executives from leading public service organizations will share what they are finding and what they believe lies ahead.

Presenters

Shawn Skelly



Shawn Skelly was director of the Office of the Executive Secretariat at the U.S. Department of Transportation from June 2016 until the end of the Obama administration in January 2017. She served more than two years special assistant to the under secretary of defense for acquisition, technology and logistics at the U.S. Department of Defense, as coordinator of the department's warfighter senior integration group. In that role, she was responsible for facilitating the departmental response to the most urgent and unique support requirements of combatant commanders, including the counter ISIL campaign and operations in Afghanistan. Skelly served on active duty in

the U.S. Navy for 20 years as a naval flight officer, retiring with the rank of commander. Prior to joining the Obama administration, she spent five years in industry with ITT Exelis. She received her bachelor's degree from the University of South Carolina and her master's degree from the U.S. Naval War College.

Bill Valdez



Bill Valdez was appointed president of the Senior Executives Association (SEA) in 2016. He sets SEA's overall strategic direction, strengthening the SEA through legislative and policy initiatives, building a leadership pipeline for the Executive Branch and establishing SEA as a thought leader in Washington, DC policy debates. He retired from federal service in 2014. His career with the U.S. Department of Energy (DOE) spanned more than 20 years, holding positions that included acting director, Office of Economic Impact and Diversity; director of business services, Office of Energy Efficiency and Renewable Energy; and director of planning and analysis, and director for workforce development, Office of Science. Valdez is an adjunct faculty member in American University's Key Leadership Program, was awarded the Presidential Rank Award (meritorious), elected a fellow of the American Association for the Advancement of Science and elected to SEA's Board of Directors and served as its Chairman. He received his master's degree from the Johns Hopkins School of Advanced International Studies.

Heidi Voorhees



Heidi Voorhees is president and co-owner of GovHR USA, a vehicle for excellence in public service through providing recruitment and selection, human resources and management consulting, and temporary staffing services for local governments across the United States. With two decades of

local government leadership and management experience, her positions included village manager and assistant village manager of Wilmette, Illinois and budget analyst for Kansas City, Missouri. Her exceptional communication style and lasting relationships have positioned her as a widely respected leader in her field across the United States. Voorhees earned her bachelor of science degree in political science from Illinois State University and a master's degree in public affairs from Indiana University's School of Public and Environmental Affairs. She was a fellow of the Eli Lilly State and Local Government Fellowship Program.

Public Administration Advancing Rule of Law in Post-Conflict Nations

SATURDAY, MARCH 9

12:15 p.m. - 1:30 p.m.

Chinese Ballroom

Global Public Administration

This panel will highlight the difficulties associated with operationalizing rule of law in post-conflict nations. Drawing on our speakers' decades of professional experiences and specific lessons learned from real nation-building scenarios, we will look at best practices for advancing rule of law in police, administrative and public institution building from around the world.

Moderator

Rich Callahan



Rich Callahan's research, consulting, publications and teaching focus on leadership behaviors, strategy and performance management practices that are effective in complex and dynamic environments in the public sector. He is a professor at the University

of San Francisco, with a joint appointment in the School of Management and the School of Nursing and Health Professions. He also is a National Academy of Public Administration fellow and editor of the *International Journal of Public Leadership*. He was a visiting researcher at Oxford University, 2016, the visiting scholar 2018 for the Center for California Studies in 2008 and a Fulbright specialist award recipient in 2011 for lectures on public institutions at Aydin University, Istanbul, Turkey. He has been published in such journals as *Public Administration Review*, *Public Management Review*, *Government Finance Officers Review* and the *National Civic Review*.

Department of Public Policy and Administration

Prepare for Public Service in a Global Environment



Congratulations to our doctoral students on their outstanding accomplishments!



Ana-Maria Dimand

PhD Student (4th Year)

- Student Representative, National Council, 2019-2020
- Recipient, SWPA Scholarship and the Wallace O. Keene Conference Scholarship



Abdul Samad

PhD Student (2nd Year)

- Recipient, Dewey W. Knight Jr. Scholarship for Public Service, ASPA South Florida Chapter



Vivian Cueto

*PhD Student
(Graduating Spring 2019)*

- Postdoctoral Fellow, Rutgers University



Steven J. Green
**School of International
& Public Affairs**

PHD IN PUBLIC AFFAIRS

- Outstanding academic placement
- Close student-faculty collaboration
- Excellent research environment

MASTER OF PUBLIC ADMINISTRATION

- Evening, online, and executive options
- Ranked #10 nationwide in International Global Policy and Administration by the U.S. News and World Report
- Variety of Graduate Certificates

BACHELOR OF PUBLIC ADMINISTRATION

- Combined BPA/MPA Degree option

Visit PA.FIU.EDU or Call 305-348-5890



Presenters

Stéphane Jean



Stéphane Jean is judicial officer and coordinator in the Office of Rule of Law and Security Institutions, Department of Peace Operations, United Nations (UN). He coordinates support for police, justice, corrections and community violence reduction for the UN Mission for Justice Support in

Haiti. He also is focal point at UN headquarters for accountability for crimes committed against peacekeepers and designated lead for justice support to the UN Multidimensional Integrated Stabilization Mission in Mali. Prior to this assignment, Jean served as justice section chief of the UN Interim Administration Mission in Kosovo. He was a judicial officer and as policy and legal affairs officer of the police division, UN Department of Peacekeeping Operations from 2004-2010. He holds a license in law and a master of international law from the University of Ottawa.

Mark Kroeker



Mark Kroeker is senior partner at Kroeker Partners LLC, a company providing justice and rule of law support in domestic and global environments. He also is an adjunct staff member and law enforcement subject matter expert for the Institute for Defense Analyses. Following 32 years of

service in the Los Angeles Police Department, he served as deputy commissioner of the International Police Task Force in the United Nations' (UN) Mission in Bosnia and Herzegovina. Later, he served as Portland, Oregon police chief for almost four years. In 2003, he was appointed the first police commissioner for the UN Mission in Liberia, West Africa, and then as police advisor and director of the police division in the UN's Department of Peacekeeping Operations in New York. Prior to launching his own company in 2015, he was senior vice president for justice and rule of law at PAE, leading State Department INL rule of law-related contracts in multiple environments around the world. Kroeker holds a bachelor's degree from California State University at Los Angeles and master's degree from the University of Southern California.

Fron Nahzi



Fron Nahzi is senior director of global development at the McCain Institute for International Leadership at Arizona State University. For more than 25 years, he lived and worked in more than 20 countries around the globe. He was responsible for developing and managing multi-million dollar

programs related to education, conflict resolution, civil society/good governance and advocacy/public policy. His project experience includes linking governments, media outlets, educational institutions and businesses to their counterparts in Europe and in the United States. In his previous international positions, Nahzi served as chief of party for USAID good governance/civil society development programs in Cambodia, Kosovo and Georgia. He served as senior editor for the Institute for War and Peace Reporting, as well. Nahzi is launching The Global Development Experiment podcast, which will bridge the gap of experience and "new" ideas by exploring successes and failures of international development projects over the past several decades, and the implications on future work in the field.

The New Financial Sustainability Framework

SATURDAY, MARCH 9

1:45 p.m. - 3:00 p.m.

Chinese Ballroom

Public Finance

The Government Finance Officers Association (GFOA) and its university partners have been researching a new model for how local governments can become financially sustainable. The model is based on a Nobel Prize-winning body of work about how communities can make better decisions about shared resources, such as a public budget. It also builds on many concepts for which GFOA has long advocated, but raises new concepts that research has shown to be vital to financial sustainability. Join this session to be introduced to the new framework, learn its essential components and find out how it has been applied.

PRESIDENTIAL PANELS

Moderator

Shayne Kavanagh



Shayne Kavanagh is senior manager of research for the Government Finance Officers Association and a leader in developing the practice and technique of long-term financial planning and policies for local government. He started GFOA's long-term financial planning and

policy line of research in 2002 and has worked with governments on financial planning and policies since. His financial planning experience also drives his research at GFOA; he is the author of a number of influential books on financial planning in city government. Prior to joining GFOA, Kavanagh was assistant village manager for Palos Park, Illinois. He received his MPA from Northern Illinois University.

Presenters

Laura Allen

Laura Allen is town administrator of Berlin, Maryland, recently voted America's Coolest Small Town. Prior to moving to the east coast in 2013, she was city manager of Colma, California for five years. She has a master's degree in public administration, as well as more than 20 years of experience working in the public sector. Allen is a graduate of the International City/County Management Association's Leadership Program and the Senior Executive Institute at the University of Virginia, Darden Graduate School of Business. A credentialed city manager and certified public finance officer, she is vice chair of the Committee on Economic Development and Capital Planning.

Mark Pisano



Mark Pisano is professor of practice at the Sol Price School of Policy, University of Southern California. He also is on the board of the National Academy of Public Administration, co-chairman of the Academy's Standing Panel on Intergovernmental Relations and co-chairman of the Infrastructure

Working Group of California Forward. From 1976-2008, Pisano directed the activities of the Southern California Association of Governments (SCAG), the nation's largest

regional planning agency that provides an open forum to explore region-wide problems. Prior to joining SCAG, he was director of the Environmental Protection Agency's water quality planning division where he was responsible for developing policy on implementation of the nation's water quality management process, including basin and facility planning and wastewater management programs. He also was an economist with the Environmental Protection Agency. Pisano recently published the book, *Puzzle of the American Economy: How Demography is Changing America's Economy and Politics*.

Shui-Yan Tang



Shui-Yan Tang is Duggan professor in public administration at the Sol Price School of Public Policy, University of Southern California. He also is a National Academy of Public Administration fellow.

Cybersecurity: "Infrastructure" and So Much More

SUNDAY, MARCH 10

8:30 a.m. - 9:45 a.m.

Chinese Ballroom

Infrastructure

The federal Cybersecurity Framework, developed by the National Institute of Standards and Technology in the U.S. Department of Commerce, was launched originally by President Obama and continued by President Trump. Infrastructure within the framework includes utilities providing energy and water, as well as sectors covering transportation, financial services, communication, health care and public health, dams, key manufacturers, emergency services and more. In fact, cybersecurity itself encompasses all that we consider "infrastructure." This panel will look at the state of our nation's cyber infrastructure and offer attendees a profound appreciation for its complexity. You also will walk away with a sense of the urgency associated with actions that must be taken to prevent multi-dimensional threats we invite if we fail to address cybersecurity challenges.

Moderator

Wendy Haynes



Wendy Haynes is special assistant to the vice president for university advancement at Bridgewater State University. A tenured full professor and former director of the NASPAA-accredited MPA program, Haynes brings a rich background of public service leadership, scholarship, teaching and

consulting to her new role. She is a seasoned “pracademic,” having served in a variety of state and local government leadership roles across the United States. Intrigued by systems for ensuring institutional accountability and smart strategic planning, she served for 13 years in the Massachusetts Office of Inspector General, most recently as first assistant inspector general for megaproject oversight. An ASPA past president and National Academy of Public Administration fellow, she is deeply engaged in the State Department’s Young African Leader Initiative and Mandela Washington Fellowship. Haynes lives on Cape Cod with her husband and contends that being a grandmother is the best job ever.

Presenters

Amelia Estwick



Amelia Estwick is program director for the National Cybersecurity Institute at Excelsior College and faculty program director for the School of Graduate Studies Cybersecurity program. A thought leader for the college’s cybersecurity research, training and academic initiatives, Estwick

worked for 17 years for the National Security Agency and held multiple leadership positions, including technical director, within its threat operations center. She lectures on cybersecurity and STEM (science, technology, engineering, and mathematics) topics as they relate to education, national defense and public policy. She earned her doctorate and master’s degrees from The George Washington University and her bachelor’s degree from Southern University at New Orleans.

Camille Stewart



Camille Stewart is a cyber and technology attorney who brings specialized, cross-cutting perspective to bear on complex technology, cyber, national security and foreign policy issues. She recently transitioned to Google to focus on policy for the company’s mobile platforms, arriving from

Deloitte where she was cyber risk manager leading election security, cyber innovation and cybersecurity programs. Stewart was senior policy advisor for cyber infrastructure and resilience policy at the U.S. Department of Homeland Security (DHS) in the Obama Administration, focusing on domestic and international cyber and technology policy issues. Prior to that time, she worked as the senior manager, legal affairs at Cyveillance, Inc. She is a New America cyber policy fellow, Truman national security fellow and Council on Foreign Relations term member. Stewart is a 2018 New America Black American National Security and Foreign Policy Next Generation leader and 2018 National Urban League honoree.

No Time to Wait

SUNDAY, MARCH 10

11:45 a.m. – 1:00 p.m.

Chinese Ballroom

Public Service

Whether recognized or not, today’s federal civil service is in a state of dysfunction that is creating a genuine national crisis—one that must be solved immediately. Our country needs a public service workforce that is equipped to do the people’s work, managed effectively and structured to support our country for generations to come. How do we get there? The National Academy of Public Administration’s “No Time to Wait” reports, released in 2017 and 2018, identified specific problems and provided thoughtful solutions. Recommendations on the table include flexibility in support of mission; replacing job specifications with a competency-based, talent-management model; reinforcing merit-system principles; leading from the center; and transforming the federal government’s human capital backbone. What has been done with these recommendations? This panel will look at that question and more.

PRESIDENTIAL PANELS

Moderator

Thelma Hite-Harris



Thelma Harris, president and CEO of Hite Consulting, Inc., served as project director on Part I and II of the “No Time to Wait” project for the National Academy of Public Administration. She has served as a member of the Senior Executive Service for the Internal Revenue Service, where she consolidated

four Treasury complaint centers into one, managed the IRS education and development program for executives and senior leaders, and designed and delivered a Quality Improvement Training Program. She also has been a human resources advisor to the inspector general of the U.S. Department of Housing and Urban Development and led the Mid-Atlantic regional EEO and diversity operation for the U.S. Office of Personnel Management. Her consulting work has focused on providing services in leadership development, human resource consultation, systems and process analysis, and general management consulting services. Hite-Harris holds a bachelor’s degree from Morgan State University and completed graduate human resource courses at Temple University.

Presenters

Anita Blair



Since June 2017, Anita Blair has served as deputy assistant secretary of defense for civilian personnel policy. Her responsibilities include development and oversight of civilian personnel plans, policies and programs that affect more than 930,000 defense employees

worldwide. Previously, she served in the U.S. Department of the Treasury as deputy assistant secretary for human resources and chief human capital officer. From 2001 to 2009, she was deputy assistant secretary of the Navy and, starting in January 2008, acting assistant secretary for manpower and reserve affairs. Prior to entering the federal government, Blair practiced business law and litigation. She earned her law degree from the University of Virginia School of Law and her bachelor’s degree from the University of Michigan.

Maggie Mello



Maggie Mello joined the Volcker Alliance in January 2016 and serves as associate director. She develops and manages the Alliance’s efforts working with universities, government agencies and other nonprofit and private sector organizations to execute projects that help answer how to

best educate, train and motivate the current and next generation of great public servants. Previously, she was an associate at MDRC, a nonpartisan social policy research organization, where she was responsible for managing a large portfolio of federally funded projects. Mello holds degrees from Barnard College, Columbia University and the McCourt School of Public Policy at Georgetown University.

Peter Warren



Peter Warren is associate director at the Office of Management and Budget (OMB), appointed in March 2018. As head of the Performance and Personnel Management (PPM) Division, he is the lead policy official within OMB for federal workforce issues, including pay and benefits, hiring

and performance management and labor relations. PPM also is the budget office for the Office of Personnel Management (OPM) and other federal personnel agencies, and coordinates the government-wide reorganization effort and agency performance planning. Previously, Warren was a senior advisor to the OMB director, director of oversight and senior budget analyst for the U.S. Senate Committee on the Budget, and policy director for the House Committee on Oversight and Government Reform. Warren earned his undergraduate degree from Binghamton University (SUNY) and graduate degree from American University.

University Nervous Areas of Government: Monuments and Reparations

SUNDAY, MARCH 10

3:15 p.m. - 4:30 p.m.

Chinese Ballroom

Social Equity

Should Confederate monuments remain on public university campuses? Should well-endowed public universities that realized substantial economic benefits from slavery provide scholarships to slaves' descendants? This panel considers these nervous areas of government by university administrators and researchers who have led efforts directly to engage these topics. Beyond apologies, this panel examines tangible strategies for correcting historical wrongs and the implications for public universities that are navigating this challenge.

Moderator

Susan T. Gooden



Susan T. Gooden is interim dean and professor of the L. Douglas Wilder School of Government and Public Affairs at Virginia Commonwealth University. She is an internationally recognized social equity expert, a National Academy of Public Administration fellow and ASPA past president. Her

research has been funded by several organizations, including the Russell Sage Foundation, the Kellogg Foundation, the Smith Richardson Foundation, MDRC and the Manhattan Institute for Policy Research. She was appointed to the Commission on Peer Review and Accreditation, the accrediting arm of the Network of Associated Schools of Public Policy, Affairs and Administration. She previously served as an elected member to the national policy council of the Association for Public Policy Analysis and Management. In 2016, she was appointed to the Virginia Community College System board by Governor Terence McAuliffe. She earned her master's degree from Virginia Tech and her doctorate from the Maxwell School of Citizenship and Public Affairs at Syracuse University.

Presenters

Curtis Brown



Curtis Brown is chief deputy state coordinator at the Virginia Department of Emergency Management. He has homeland security and emergency management experience at the federal, state and local levels, having served as deputy secretary of public safety and homeland

security an regional emergency management administrator for the Hampton Roads Planning District Commission; professional staff on the U.S. House of Representatives Committee on Homeland Security; and senior special assistant to the governor in the Office of Commonwealth Preparedness. Brown is recognized as a certified emergency manager by the International Association of Emergency Management. He received a bachelor of science from Radford University, master of public administration from Virginia Tech and master of arts in homeland security and emergency preparedness from Virginia Commonwealth University.

Hannah Cameron



Since 2017, Hannah Cameron has served as co-chair on Virginia Commonwealth University's History and Civil Rights Working Committee. She earned a master of urban and regional planning degree from the L. Douglas Wilder School of Government and Public Affairs at VCU in May 2018.

During her graduate studies and research, Cameron developed a passion and interest in learning the ways in which commemoration in public space influences urban planning disciplines and ways that a city's identity emerges from this intersect.

PRESIDENTIAL PANELS

John Stephens



John Stephens joined the University of North Carolina—Chapel Hill’s School of Government in 1996. Previously, he was research director of the Ohio Commission on Dispute Resolution and Conflict Management. His publications include *Guidebook to Public*

Dispute Resolution in North Carolina and *Public Management Bulletin: Using a Mediator in Public Disputes*. He is co-author of *Reaching for Higher Ground: Tools for Powerful Groups and Communities* and *School Funding Disputes: Mediate, Don’t Litigate*. He serves on the steering committee of the University Network for Collaborative Governance. He earned a bachelor’s degree from Earlham College, a master of philosophy from The City University, London and doctorate from George Mason University’s School for Conflict Analysis and Resolution.

Managing Our Country’s Watershed Infrastructure

MONDAY, MARCH 11

8:00 a.m. - 9:15 a.m.

Chinese Ballroom

Infrastructure

Many U.S. communities are dependent on human management of large natural watersheds. The Mississippi River drainage basin encompasses lands in 32 states. The Colorado and Columbia Rivers each drain parts of seven states. The Chesapeake Bay watershed encompasses parts of six states. The infrastructure projects that altered and now manage these watersheds include dredging, dams, levees and more with a variety of policy goals, including flood control, irrigation, power generation, navigation and recreation. In addition, climate change is projected to include severe rainfall, “flashier” floods and sea level rise in coastal areas, which only will increase today’s challenges. This panel will examine the range of policy goals affecting our nation’s watersheds.

Moderator

John Kirlin



Distinguished Professor of Public Policy John Kirlin is founding director of the University of the Pacific McGeorge School of Law’s Public Policy Program, offering two degrees: master’s of public policy and master’s of public administration. The author of more than 100 articles, chapters and

monographs and 13 books, he is a National Academy of Public Administration fellow and has served as a consultant to the State of California on matters ranging from species protection to oversight of local government debt to the interface of energy and environmental policies. Kirlin served as executive director of the Marine Life Protection Act Initiative, making recommendations to the California Fish and Game Commission for protection of marine life along the California coast, and executive director of Delta Vision, reframing state water policies and ecosystem vitality in the Delta, foundational work for a major package of legislation enacted in 2009.

Presenters

Carin Bisland



Carin Bisland is associate director for the Office of Partnerships and Accountability at the Environmental Protection Agency (EPA) Chesapeake Bay Program Office. She is responsible for coordinating federal, state and local partnership actions to improve water quality, habitat and

living resource conditions in the Chesapeake Bay and its rivers. Her office’s responsibilities include coordinating within and between Chesapeake Bay Program partner teams and committees; using and developing ChesapeakeStat as a series of sites that provide transparency and accountability on Chesapeake Bay restoration progress and support for decisionmaking using adaptive management; and developing and using indicators and performance measures. Prior to her current role, Bisland worked at EPA headquarters during the development and expansion of the National Estuary Program; she coordinated the west coast estuary programs. She also was a researcher at the Smithsonian Environmental Research Center. Bisland received her bachelor’s degree from College of Wooster and master’s degree from Duke University.

James Davis-Martin



James Davis-Martin is Chesapeake Bay program manager for the Virginia Department of Environmental Quality. His education in marine science is supplemented by work experience with the Army Corps of Engineers, National Oceanic and Atmospheric Administration, Coast Guard and

20 years with the Commonwealth of Virginia working on Chesapeake Bay restoration efforts. He is co-chair of the Chesapeake Bay program's Water Quality Goal Implementation Team, where he works in cooperation with the Chesapeake Bay jurisdictions, EPA and stakeholders to chart the course for Bay restoration.

Mary Gattis



Mary Gattis has more than 30 years' experience working on environmental issues in the public, private and not-for-profit sectors. She served most recently as coordinator of the Local Government Advisory Committee to the Chesapeake Executive Council, whose mission is to

improve policies and programs affecting local governments in the watershed. Prior to the role, she was senior environmental planner with the Lancaster County Planning Commission in Pennsylvania, where she was responsible for drafting the county's first integrated water resources plan. Gattis serves as vice president of the Chesapeake Stormwater Network Board of Directors.

#MeToo: The Role of Universities in the MeToo Movement

MONDAY, MARCH 11

11:15 a.m. - 12:30 p.m.

Chinese Ballroom

Social Equity

Are universities taking a proactive stance in addressing sexual harassment and assault? The #MeToo movement has played a critical role in the number of persons coming forward with claims of sexual harassment and assault in recent years. Colleges and universities are not immune to these claims; we have seen several university cases highlighted in major media outlets. How do universities manage situations when graduate students claim they are being sexually harassed or assaulted by a professor? This panel will assess the magnitude of harassment and assault

in colleges and universities and discuss best practices in changing the culture of organizations and addressing the problem at the grassroots level.

Moderator

Charles E. Menifield



Charles Menifield is dean of the School of Public Affairs and Administration at Rutgers University—Newark. His research interests lie primarily in the areas of budgeting and financial management, public health and welfare, and policing. Other areas include public management

information systems, education finance and public administration education. He has two books on minority politics and two on public budgeting and financial management. His most recent articles have appeared in *Public Administration Review*, the *Journal of Public Budgeting, Accounting and Financial Management*, *International Journal of Public Administration* and *State and Local Government Review*. Menifield's current research examines the impact of the CHIP program on reducing the number of uninsured children, changes in gun laws and police killings in the United States. He previously served as associate dean in the School of Public Affairs at the University of Missouri—Columbia and as director of the public administration program at the University of Memphis.

Presenters

RaJade Berry-James



RaJade Berry-James is associate professor of public administration in the School of Public and International Affairs and resident faculty in the Center for Genetic Engineering and Society at North Carolina State University. She is a life member of ASPA, a member of NASPAA's Executive Council and

past chair of the Commission on Peer Review and Accreditation. Her research and teaching interests focus on social equity, program evaluation and research methods. Her recent book, *Why Research Methods Matter: Essential Skills for Decision Making* (2018), examines research applications to support evidence-based decisionmaking. A native of New Jersey, she received her bachelor's degree from Rider University, a master in public administration from Kean University and her doctorate in public administration from Rutgers University—Newark.

PRESIDENTIAL PANELS

Nicole Elias



Nicole Elias is assistant professor in the Department of Public Management at John Jay College of Criminal Justice, CUNY and co-founder of Women in the Public Sector at John Jay College. Her research, teaching and service fall under the broad umbrella of social equity in public administration and

policy. She is a research fellow with the U.S. Department of Defense's Equal Opportunity Management Institute, held a research fellowship at the U.S. Equal Employment Opportunity Commission and served as lead faculty advisor to the U.S. Office of Personnel Management on the 2016 government-wide inclusive diversity strategic plan. Elias is co-recipient of John Jay College's 2018-2019 inaugural Presidential Student-Faculty Research Collaboration Award, examining gender equity in municipalities. She is author of numerous pieces, her most recent published in the *Journal of Public Management & Social Policy* and *Public Integrity*. She is co-editor of a symposium on the future of women in public administration appearing in *Administration & Society*.

Donna Greco



Donna Greco is policy director at the Pennsylvania Coalition Against Rape (PCAR). She has advocated on behalf of sexual assault survivors for mainly 20 years—as a legal advocate, community organizer, social worker and trainer. As PCAR's policy director, she has the privilege of working

with legislators, staff and partners to ensure Pennsylvania laws are responsive to the needs of sexual assault victims and their families, systems and communities that surround them. Greco's brief experience as a Title IX Coordinator in higher education has given her insight into some of the strengths and challenges in addressing campus sexual assault in a victim-centered manner.

Mindy Weinstein



Mindy Weinstein is acting director of the Equal Employment Opportunity Commission's (EEOC) Washington field office. She oversees operations that include investigations, mediations, federal sector hearings and community outreach and education. Prior to her current role, she served as a

special assistant to EEOC Vice Chair Leslie E. Silverman, to whom she provided legal and policy guidance on a wide range of matters, and helped lead the EEOC's systemic task force. Weinstein's prior positions include regional attorney in the EEOC's office in Charlotte, North Carolina; attorney in the EEOC's Systemic Litigation program in Washington, DC; special assistant to former EEOC Chairman Evan Kemp, trial attorney in the EEOC's Baltimore office; and special assistant U.S. attorney in Washington, DC. She is a graduate of Wellesley College and The George Washington University School of Law.

America's Infrastructure: Is a D+ Acceptable?

MONDAY, MARCH 11

12:45 p.m. - 2:00 p.m.

Chinese Ballroom

Infrastructure

Every four years, the American Society for Civil Engineers (ASCE) issues an Infrastructure Report Card. According to the most recent scores, America's infrastructure earned a D+ overall, an alarmingly substandard grade for structures that undergird the nation's economic health, domestically and globally. ASCE contends that the nation's infrastructure problems are solvable with sufficient investment, leadership and planning—and a clear vision for the future. But, those elements are the crux of the matter, aren't they? Who pays and who benefits? And, who is in charge? This conversation features experts in infrastructure investment, system safety and leadership and planning who will discuss where we go from here.

Moderator

Wendy Haynes



Wendy Haynes is special assistant to the vice president for university advancement at Bridgewater State University. A tenured full professor and former director of the NASPAA-accredited MPA program, Haynes brings a rich background of public service leadership, scholarship, teaching and

consulting to her new role. She is a seasoned “pracademic,” having served in a variety of state and local government leadership roles across the United States. Intrigued by systems for ensuring institutional accountability and smart strategic planning, she served for 13 years in the Massachusetts Office of Inspector General, most recently as first assistant inspector general for megaproject oversight. An ASPA past president and National Academy of Public Administration fellow, she is deeply engaged in the State Department’s Young African Leader Initiative and Mandela Washington Fellowship. Haynes lives on Cape Cod with her husband and contends that being a grandmother is the best job ever.

Presenters

Casey Dinges



Casey Dinges is senior managing director at the American Society of Civil Engineers (ASCE), where he oversees major components of the Society, including government relations, communications and strategic planning, membership and marketing and web operations. He provided executive level

leadership during development of the high-profile 2017 Report Card for America’s Infrastructure, as well as for the 3D IMAX film, *Dream Big: Engineering Our World*. Numerous programs under his oversight have earned awards and recognition during his three decade career, including from those American Society of Association Executives, the Construction Writers Association of America and the American League of Lobbyists. Prior to joining ASCE in 1985, Dinges worked for the Environmental Fund, National Audubon Society and Congressman Sidney R. Yates (D-IL). He earned his bachelor’s degree from Wesleyan University in 1979.

Brandye Hendrickson



Brandye Hendrickson was named deputy administrator of the Federal Highway Administration (FHWA) in July 2017 after having built a reputation as a strong leader as commissioner of the Indiana Department of Transportation. As FHWA’s deputy administrator, she puts her 20

years of business experience to work leading a 2,900-person federal agency and maximizing its \$44 billion annual budget. She is only the second woman to head the FHWA and has a deep appreciation for the strength of an organization filled with people of different backgrounds and perspectives. She has a bachelor’s degree from Indiana University and is a professional in human resources.

Paul Wiedefeld

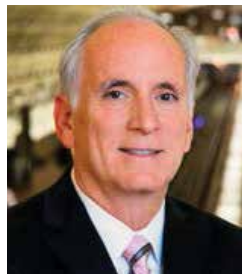

Paul Wiedefeld became general manager and chief executive officer of Washington Metro in 2015. Since that time, Metro has turned the corner on safety, service reliability and financial management. Through its Back2Good program, Metrorail is delivering nine out of 10 customers

to their destinations on time; customer satisfaction has reached the highest levels in recent years; and Metro has received a clean, on-time financial audit for three consecutive years. For the first time in the organization’s existence, under his leadership, WMATA has received dedicated regional capital funding from local, state and federal governments. Throughout his time at Metro, Wiedefeld has focused on the customer experience, including introducing such customer amenities as the Rush Hour Promise, which automatically credits rail customers for trips delayed by 15 minutes or more. Prior to joining Metro, he was chief executive officer of BWI Airport and chief executive officer of the Maryland Transit Administration. Wiedefeld has a master’s degree from Rutgers University.

PRESIDENTIAL PANELS

Census 2020: A Count That Matters

MONDAY, MARCH 11

2:15 p.m. - 3:30 p.m.

Chinese Ballroom

Social Equity

Mandated by the U.S. Constitution, the decennial census is a count that matters. It impacts voting representation, as well as funding allocations for such areas as education, health care and housing. This panel will examine the challenges associated with Census 2020 for public administrators, including the continued vacancy of a Census Bureau director, reduced administrative capacity to administer the census, conflicting federal guidance on census questions related to citizenship, race and ethnicity, and increased fear among immigrants to complete the census.

Moderator

Susan T. Gooden



Susan T. Gooden is interim dean and professor of the L. Douglas Wilder School of Government and Public Affairs at Virginia Commonwealth University. She is an internationally recognized social equity expert, a National Academy of Public Administration fellow and ASPA past president. Her

research has been funded by several organizations, including the Russell Sage Foundation, the Kellogg Foundation, the Smith Richardson Foundation, MDRC and the Manhattan Institute for Policy Research. She was appointed to the Commission on Peer Review and Accreditation, the accrediting arm of the Network of Associated Schools of Public Policy, Affairs and Administration. She previously served as an elected member to the national policy council of the Association for Public Policy Analysis and Management. In 2016, she was appointed to the Virginia Community College System board by Governor Terence McAuliffe. She earned her master's degree from Virginia Tech and her doctorate from the Maxwell School of Citizenship and Public Affairs at Syracuse University.

Presenters

Albert E. Fontenot, Jr.



Albert Fontenot is associate director, Decennial Census Programs, U.S. Census Bureau. He is responsible for providing executive leadership and direction for 2020 census programs and operations, the American Community Survey and the bureau's geographic programs. He

previously was assistant director for field operations, where he oversaw the field division, six regional offices, National Processing Center and Office of Survey and Census Analytics. He also served as director of the Chicago region, assistant regional director of the Los Angeles region and in other key leadership roles in the Los Angeles region. Fontenot joined the Census after retiring from a successful career as a senior corporate executive in the private sector, including more than 12 years as president and chief executive officer. He received a bachelor's degree in management and a master of business administration from DePaul University in Chicago. He also holds a doctor of ministry in pastoral ministry.

Mary Jo Hoeksema



Since January 2004, Mary Jo Hoeksema has been director of government affairs for the Population Association of America (PAA) and Association of Population Centers (APC). In addition, she has co-directed The Census Project since 2008. Prior to her position with PAA/APC, she

worked at the National Institutes of Health (NIH) for approximately 10 years as legislative officer at the National Institute on Aging and special assistant to the director of the NIH Office of Policy of Extramural Research Administration. Hoeksema served as a legislative assistant for Congresswoman Rosa DeLauro and legislative correspondent for U.S. Senator Jeff Bingaman. She has a master of public administration from The George Washington University and is a former presidential management fellow.

Beth Lynk



Beth Lynk is director of the Census Counts Campaign at The Leadership Conference on Civil and Human Rights, the nation's oldest, largest and most diverse civil and human rights coalition. She previously served as associate director of federal communications for Planned Parenthood Federation

of America and Planned Parenthood Action Fund, focused on shaping the organizations' political communications and media narrative around federal policy, congressional issues and related lawsuits. She was a senior associate at the Raben Group and served in the office of Congresswoman Jan Schakowsky. Lynk is a graduate of Northwestern University.

Arturo Vargas



Arturo Vargas is chief executive officer of the NALEO Educational Fund, a national nonprofit organization that strengthens American democracy by promoting the full participation of Latinos in civic life. He also serves as chief executive officer of NALEO, the national membership organization

of Latino policymakers and their supporters. Vargas is a nationally recognized expert in Latino demographic trends, electoral participation, voting rights, the census and redistricting and has held his current positions since 1994. He has a master's degree in education and a bachelor's degree from Stanford University.

Developing the Next Generation of Public Service Leaders

MONDAY, MARCH 11

3:45 p.m. - 5:00 p.m.

Chinese Ballroom

Public Service

Career federal leaders are the tip of the spear when it comes to advancing a public service ethic and restoring the public's confidence in government during turbulent and disruptive times. But, what are those leaders doing to promote the next generation of federal public service leaders and build the leadership development pipeline programs needed to recruit and retain 21st century leaders? This panel will explore exemplar federal agency leadership development programs, system level constraints that encourage and/or inhibit their

development and federal and academic perspectives on how to best prepare our next generation of public servants for the demands of federal leadership.

Moderator

Bill Valdez



Bill Valdez was appointed president of the Senior Executives Association (SEA) in 2016. He sets SEA's overall strategic direction, strengthening the SEA through legislative and policy initiatives, building a leadership pipeline for the Executive Branch and establishing SEA as a thought

leader in Washington, DC policy debates. He retired from federal service in 2014. His career with the U.S.

Department of Energy (DOE) spanned more than 20 years, holding positions that included acting director, Office of Economic Impact and Diversity; director of business services, Office of Energy Efficiency and Renewable Energy; and director of planning and analysis, and director for workforce development, Office of Science. Valdez is an adjunct faculty member in American University's Key Leadership Program, was awarded the Presidential Rank Award (meritorious), elected a fellow of the American Association for the Advancement of Science and elected to SEA's Board of Directors and served as its Chairman. He received his master's degree from the Johns Hopkins School of Advanced International Studies.

Presenters

Angela Evans



Angela Evans is dean and fellow of J. J. "Jake" Pickle Regents Chair in public affairs at the LBJ School of Public Affairs, The University of Texas at Austin. She joined the LBJ School in 2009 as clinical professor of the practice of public policy following 40 years of service to the U.S. Congress, thirteen of them as

deputy director of the Congressional Research Service, Congress' primary source for policy research and analysis. During her 40 years working for Congress, she worked directly with members and their staff on major legislative deliberations and supported them as they confronted some of the nation's most critical and complex problems. Since joining the LBJ School, Evans has earned teaching accolades, including the Texas Exes Teaching Award. She is a fellow of the National Academy of Public Administration, served as president of the Association for Public Policy Analysis and Management and was on NASPAA's governing board. She earned her bachelor's

PRESIDENTIAL PANELS

degree from Canisius College and her master's degree from the University of Wisconsin at Madison.

Dustin Brown



Dustin Brown is deputy assistant director for management at the Office of Management and Budget (OMB) in the Executive Office of the President. A member of the Senior Executive Service, he is career lead for the federal government's efforts to improve the results of government through

the President's Management Agenda and federal performance framework. He helps lead OMB's Office of Performance and Personnel Management, which is responsible for leading several government-wide initiatives that require coordination across agencies; improving the federal government's mission performance outcomes; and developing federal personnel policies. In 2010, Brown worked with Congress to overhaul the federal government's performance framework through the Government Performance and Results Act Modernization Act. He is a fellow of the National Academy of Public Administration, a senior visiting fellow at the Volcker Alliance and visiting fellow of practice at Oxford University's Blavatnik School of Government. He has a master's degree in public administration from the Maxwell School of Citizenship and Public Affairs at Syracuse University and a bachelor's degree from Manchester University in Indiana.

Angela Bailey



Angela Bailey has dedicated more than 35 years to public service, with almost thirty of them in human resources. Appointed as the U.S. Department of Homeland Security's (DHS) chief human capital officer in January 2016, she is responsible for the department's human capital program, including

human resources policy, systems and programs for strategic workforce planning, recruitment and hiring, pay and leave, performance management, employee development, executive resources, labor relations, work/life balance and safety and health. Prior to joining DHS, Bailey served as chief operating officer, deputy associate director for recruitment and hiring, associate director for employee services and chief human capital officer for the U.S. Office of Personnel Management. She began her

career with the Social Security Administration and later worked for the U.S. Department of Defense in different components and agencies. Bailey has an MA from Bellevue University and participated in Harvard University's Kennedy School National Preparedness Leadership Initiative for Executives in 2012.

Robert Goldenkoff



Robert Goldenkoff has more than 30 years of federal program evaluation experience at the U.S. Government Accountability Office (GAO). Currently, he is a director on GAO's strategic issues team, where he leads a portfolio of work aimed at improving federal agencies' ability to recruit and

retain a top-notch workforce, and strengthening the performance and independence of the federal statistical system. He is an adjunct faculty member of GAO's Learning Center. Goldenkoff also serves on the Advisory Board of The George Washington University's Trachtenberg School of Public Affairs and Public Administration, and his articles on federal management, science policy and other subjects have been published in various journals. He received his MPA from The George Washington University and was a presidential management fellow.

Significant Risks in Higher Education—The Future Is in Our Hands

TUESDAY, MARCH 12

8:00 a.m. - 9:15 a.m.

Chinese Ballroom

Public Finance

The higher education sector is changing rapidly. Some shifts have been years in the making and follow other patterns and cultural trends; others are the result of recent disruptions to the sector itself, such as in student loans and college affordability. As the model for higher education evolves, new risks will emerge, known risks will take new forms and have more extensive impacts, and crises inevitably will unfold. Universities must be comfortable with a "new normal" of perpetual discomfort. At this session, you will hear from leaders from all sides of the sector, who will share their perspectives on the risks for higher education and possible considerations for institutions in dealing with these challenges moving forward.

Moderator

Cynthia Vitters



Cynthia Vitters is a Deloitte risk and financial advisory managing director at Deloitte & Touche LLP and assists government, public sector and higher education clients in developing and implementing enterprise risk management (ERM) programs. She has more than 20 years of federal ERM and

financial management experience at the U.S. Department of Education's Office of Federal Student Aid, where she served as chief risk officer.

Presenters

Michael Dean



Michael Dean is chief risk officer and senior executive head of portfolio, risk and data at the U.S. Department of Education, Federal Student Aid (FSA). There, he leads a transformative effort to deliver commercial, best-in-business practices in managing FSA's student lending portfolio. FSA's

\$1.5 trillion portfolio is the largest single-purpose consumer lending portfolio in the world, accounting for more than 30 percent of all U.S. government assets, 70 percent of all receivables and nearly seven percent of the national debt. He also is responsible for leading the management of enterprise-wide risks, including policy and compliance, business operating units, cybersecurity and financial and reputational risks. Dean has a passion for driving innovation and change in higher education finance. He received his bachelor's degree in accounting, his master's degree in enterprise systems and brand management and doctorate in educational administration and higher education from Southern Illinois University Carbondale.

Luke Figora



Luke Figora is senior associate vice president and chief risk and compliance officer at Northwestern University in Evanston, Illinois. In this role, he oversees a team of 55 professionals covering risk management, university compliance, internal audit and business services. He oversees the

university's enterprise risk management program and works closely with the audit, risk and compliance committee of the Board of Trustees to ensure risks are appropriately addressed throughout the institution. He joined Northwestern in 2015. He holds a master's degree in business administration from the University of Chicago Booth School of Business and a bachelor's degree from Lake Forest College.

Julie A. Zobel



Julie Zobel is assistant vice president for safety, emergency and enterprise risk management at George Mason University. She began working in safety and compliance in 2000 as the university biological safety officer, chemical hygiene officer and assistant radiation safety officer,

and later as director of laboratory safety. In 2007, Zobel's role expanded as she worked with university officials to establish the university's first environmental health and safety office, and then again in 2015 when she became responsible for the Office of Risk Management. She earned bachelor's degrees from the University of Findlay and the University of Akron where she also earned a master of science degree. She received her doctorate in biodefense from George Mason University.

PARTNER ORGANIZATION SESSIONS

Friday, March 8

12:45 p.m. - 2:00 p.m. Senate

NISPAcee Session—Three Decades of Reform in Central and Eastern Europe and Central Asia: What Has Been Achieved?

See page 96 for more information

Saturday, March 9

10:45 a.m. - 12:00 p.m. Rhode Island

KIPA Session—Promoting Innovative and Inclusive Government: Korea Experiences

See page 108 for more information

3:15 p.m. - 4:30 p.m. Massachusetts

NAPA Session—Grand Challenges in Public Administration in the 2020s: The View from Multiple Sectors

See page 124 for more information

4:45 p.m. - 6:00 p.m. Independence

NASPAA Site Visitor Training

See page 128 for more information

4:45 p.m. - 6:45 p.m. New York

Astana Civil Service Hub (ACSH) Session—Modern Trends and Challenges of Public Service in Post-Soviet and Transition Countries

See page 130 for more information

Sunday, March 10

8:30 a.m. - 9:45 a.m. Independence

NIGP Session—Creating Impact through Strategic Procurement

See page 138 for more information

3:15 p.m. - 4:30 p.m. Pennsylvania

IIAS Session—Trends in Public Administration Teaching and Accreditation

See page 150 for more information

3:15 p.m. - 4:30 p.m. Independence

ARNOVA Session—Empowering Marginalized Groups' Democratic Activism

See page 156 for more information

Monday, March 11

8:00 a.m. - 9:15 a.m. Maryland

AIRMAP Session—Advancing in French Public Services

See page 165 for more information

12:45 p.m. - 2:00 p.m. Pennsylvania

Korean Association for Policy Studies (KAPS) Session

See page 180 for more information

3:45 p.m. - 5:00 p.m. Rhode Island

KAPA Session—Understanding Public Officials in Korea

See page 186 for more information

Tuesday, March 12

9:30 a.m. - 10:45 a.m. South Carolina

University of Seoul Session: Seoul's Policies for Urban Management

See page 199 for more information

9:30 a.m. - 10:45 a.m. New Jersey

KAPA Session—Understanding Public Officials in Korea: Understanding Policy Behaviors

See page 200 for more information

WELCOME RECEPTION

SATURDAY, MARCH 9, 2019

6:30 p.m. - 8:30 p.m.

The Mayflower Hotel, Grand Ballroom
1127 Connecticut Avenue NW • Washington, DC 20036

The 2019 Annual Conference Welcome Reception will take place at the prestigious Mayflower Hotel, the host hotel for the conference and a historic venue in Washington, DC. There could be no more perfect location for this special event as we celebrate ASPA's 80th Anniversary and welcome attendees to this year's premier conference.

As one of the most historic hotels in the city, The Mayflower Hotel, Autograph Collection has welcomed locals and visitors alike into its elegantly gilded hallways and gloriously appointed spaces for nearly a century, playing host to inaugural balls, the elite of the city, the famous and the infamous, decades of society weddings and legions of guests who just want to be in the center of it all.

Just some of the many highlights include:

- Elected president in 1932, Franklin D. Roosevelt prepared to deliver an inaugural speech intended to reassure U.S. citizens amidst an economic depression. On March 3, 1933 in room 776 on the eve of his inaugural address, President Roosevelt penned one of the most famous lines in U.S. political history, "The only thing we have to fear is fear itself."
- The Carvery Restaurant and Coffee Shop's most famous guest, FBI Director J. Edgar Hoover dined here nearly every working day for 20 years until his death in 1972, always selecting the same menu items. It is also there that President Harry Truman, another frequent restaurant patron, gave the hotel its tagline, "Washington's Second Best Address."



- After a major renovation, The Mayflower Hotel was placed on the National Register of Historic Places in 1983 and later named to the National Trust's Historic Hotels of America in 1989.
- The longest suspension of play in American baseball occurred in 1994 when the remainder of the season was cancelled. In a disagreement regarding player salaries, owners and players met at The Mayflower to come to a resolution. Discussions, which involved input from President Bill Clinton and Congress, finally ended the strike after 234 days.

The Welcome Reception will feature a special tribute to 80 years of advancing excellence in public service, as well as special hors d'oeuvres, drinks, live music and plenty of space for networking.

Premier Sponsor:



Sponsors:

Cleveland State University, Maxine Goodman Levin College of Urban Affairs

Southeastern Conference for Public Administration (SECoPA)

Wiley

STUDENT & NEW PROFESSIONAL SUMMIT

FRIDAY, MARCH 8, 2019

8:00 a.m. – 3:15 p.m.

Palm Court Ballroom

This annual event focuses on topics that are critical to students and new professionals: building a resume or CV, getting a job, making tenure and getting published. Whether you are planning for a practitioner career or an academic one, you will want to be at the summit to learn from experts in the field while networking with colleagues and leading public administrators.

STUDENT SUMMIT MASTER OF CEREMONIES

Lindsey Evans

Assistant Professor, University of Louisville

8:00 a.m. – 8:30 a.m.

Getting Started

A career in public service can mean many things. What level of government is of most interest to you and what topic area is most inspiring? Where are your skills best suited and what kind of schedule will work best for your work/life balance? These are all questions to consider as you start to plan life beyond your degree. Our expert will address them and more from personal perspective.

PRESENTER

Carol Rusaw

Retired

8:30 a.m. – 8:45 a.m.

Small Group Discussions: Personal Experiences

8:45 a.m. – 9:45 a.m.

Resumes and CVs: Selling Yourself

Now that you have given some thought to your career aspirations, it's time to tailor your resume or CV to match. Whether you're 22 or 52, your life experiences, previous job history, skills, languages, publications, expert projects and more could fill pages. What is most valuable to a future employer and what is most relevant to what you want to do next? This workshop will walk you through dos and don'ts, frequent mistakes made and the essentials to be included on a CV or a resume, depending on where your future takes you. Bring a copy of your paperwork and all of your questions; you'll need them to make the most of this session. Q-and-A time will be provided.

PRESENTERS

Alexander Henderson

Associate Professor of Health Care and Public Administration, Long Island University

Saltanat Liebert

Associate Professor, Virginia Commonwealth University

William Shields, Jr.

Executive Direction, ASPA and Adjunct Professor, American University

9:45 a.m. – 10:10 a.m.

Cover Letters: Why Do They Matter?

If your cover letter only repeats what a future employer will see on your resume or CV, you're not writing it correctly. Cover letters are a critical piece of your application package, no matter the job for which you are applying. We will talk through how to best use a cover letter from a variety of professional angles. Experience examples, must-use language, cover letter protocol and more will be addressed.

PRESENTER

Sean McCandless

Associate Professor, University of Illinois—Springfield

10:10 a.m. – 10:30 a.m.

Networking Break

10:30 a.m. – 11:00 a.m.

The Job Search

Not all job searches are created equal and not all search engines will turn up relevant results. We will look at some of the prominent sources for public service jobs and careers, how to best use keyword searches to find even more opportunities and where to look creatively when standard stones are turned, to no avail. Plus, learn how to use USAJobs.gov if you're headed toward a federal career path and what pitfalls to avoid when doing so.

STUDENT & NEW PROFESSIONAL SUMMIT

PRESENTERS

Rashmi Chordiya

Assistant Professor, Institute of Public Service, Seattle University

Deborah Eichhorn

Recruitment Program Manager, Human Capital Office, U.S. Government Accountability Office

11:00 a.m. - 11:10 a.m.

Small Group: Job Search Resources

Break into small groups to share resources you have found helpful as you've begun to navigate job searches.

11:10 a.m. - 12:00 p.m.

The Interview

Congratulations! You have an interview. How do you make sure it goes well? Our expert will provide you with key tips, musts and nevers to ensure you make a good impression, hopefully get a call-back and, even better, get the job. Bring your questions—better to ask now than to make a mistake later.

PRESENTER

J. Paul Blake

Retired, ASPA National Council District IV Representative

12:00 p.m. - 1:00 p.m.

Lunch On Your Own

1:00 p.m. - 1:30 p.m.

Networking: More Than Happy Hours and Business Cards

Need we say more? To be truly effective at networking, you must integrate it into your daily life. Yes, happy hours are helpful and you should always have business cards in your pocket—but that is because those habits are just two pieces of a larger puzzle. So are staying connected with former colleagues and friends; checking in with acquaintances periodically to keep your name on their radar; building relationships with new contacts; knowing when to push yourself—and how hard to do so; and making plans for social gatherings, whether you “need” anything or not.



Grow your career *and* your community through Valdosta State University

VSU's Public Administration graduate programs offer curriculum to help you develop the analytical and quantitative thinking needed to make decisions in today's complex world.

Three programs to choose from:

- Graduate Certificate Programs
- Master of Public Administration
- Doctor of Public Administration

To get started visit us online at Valdosta.edu/PA.

STUDENT & NEW PROFESSIONAL SUMMIT

Done best, networking is a daily habit and yields important, regular returns. Learn how to do it well during this session.

PRESENTERS

Amanda Olejarski

Associate Professor, West Chester University

Kitty Wooley

Retired, Senior Fellows and Friends

1:30 p.m. – 3:00 p.m.

Career Roundtables

Spend some time having group discussions with real hiring experts and others from across all sectors of public service. They'll give you their real-world perspective, give you the chance to ask them questions and ask some of their own. Participants will move from table to table throughout this session, getting a broad range of advice from as many of the hiring experts as possible.

Just some of the organizations represented will include:
Government Finance Officers Association
Library of Congress
National Low Incoming Housing Coalition
Senior Executives Association
U.S. Government Accountability Office
University of Delaware

3:00 p.m. – 3:15 p.m.

Awards Presentation and Closing Remarks

We'll wrap up this day with some closing thoughts and honoring this year's student scholarship winners.

PRESENTER

Christopher Pierce

ASPAs Student Representative, Providence, RI

SAGE is the Proud Publisher of these Public Administration Journals



Editor:
Brian J. Cook



Editor:
Patricia M. Shields



Editors:
Stephanie P. Newbold
& Marc Holzer*



Editor:
Richard G. Little*



Editor:
Heather Getha-Taylor*



Editors:
Jessica E. Sowa &
Christine Ledvinka Rush*



Editor:
Michael
J. Scicchitano*

Register for a 30-day free online trial to these titles and more! journals.sagepub.com/freetrial

*ASPAs section sponsored journals

New Titles from CQ Press:

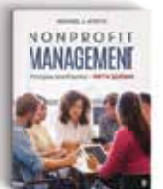

Visit sagepub.com to learn more and request a free review copy



FOUNDERS' FELLOWS RECEPTION

CLASS OF 2019
MONDAY, MARCH 11, 2019
6:30 p.m. – 7:30 p.m.
Pennsylvania

*Fellows will receive their plaques during this reception,
generously hosted by Brigham Young University.*



Michael BednarczukOhio University–Chillicothe
Christopher BurksUniversity of Alabama–Birmingham
Edgar Bustos Centro de Investigación y Docencia Económicas (CIDE)
Wendy Chen George Mason University
Donwe ChoiFlorida State University
Suparna Dutta..... Virginia Commonwealth University
Nuri HecklerUniversity of Colorado Denver
Emmy Hicks Louisiana State University
Victoria Martin-Nammour University of Central Florida
Joseph Maya-RodriguezRutgers University–Newark
Assel Mussagulova Nanyang Technological University–Singapore
Amy Owen Tennessee State University
Pooja Paswan Jamia Millia Islamia
Cimone Philpotts.....University of Delaware
Amelia Pridemore Florida International University
Mustafa Sen Mississippi State University
Jennifer Swann The City of Oklahoma, City Planning Department
Jie Tao.....University of North Texas
Shahrin Upoma The University of Texas at Dallas
Nara Yoon..... Syracuse University

Thank you to the following supporters:

Full:

ASPA Section on Personnel
Administration and Labor Relations
Brigham Young University

Merit:

Centro de Investigación y Docencia
Económicas
Public Administration Quarterly
Southeast Conference for Public
Administration (SECoPA)
University of Texas at Dallas

Book:

ASPA Association for Budgeting and
Financial Management
ASPA Evergreen Chapter
ASPA Massachusetts Chapter
ASPA North Texas Chapter
ASPA Section on Emergency and Crisis
Management
ASPA South Florida Chapter
ASPA Southern California Chapter
ASPA Students and New Administration
Professionals Section
Louisiana State University
Midwest Public Affairs Conference
Mississippi State University

Contributors:

ASPA LGBT Advocacy Alliance
ASPA New Jersey Chapter
ASPA Suncoast Chapter
J. Paul Blake
Michael Brintnall
Paul Danczyk
Mehmet Demircioglu
Janice Lachance
Grant Rissler
Stephen Rolandi
Allan Rosenbaum
Kendra Stewart
Loretta Tillery
Shilpa Viswanath
Aziza Zemrani

FOUNDERS' FELLOWS PANELS

Friday, March 8

2:15 p.m. - 3:30 p.m.

Virginia

Promoting Excellence in Education and Nonprofit Organizations

MODERATOR

Cimone Philpotts

Doctoral Student, University of Delaware

PRESENTERS

Christopher Burks

MPA Student, University of Alabama—Birmingham

Wendy Chen

Doctoral Student, George Mason University

Suparna Dutta

Doctoral Student, Virginia Commonwealth University

Nara Yoon

Doctoral Student, Syracuse University

See page 97 for more information

Saturday, March 9

10:45 a.m. - 12:00 p.m.

Virginia

Citizen Participation and the Creation of Public Value

MODERATOR

Jennifer Swann

Administrative Coordinator, City of Oklahoma City Planning Department

PRESENTERS

Michael Bednarczuk

Adjunct Instructor, Political Science, Ohio University—Chillicothe

Donwe Choi

Doctoral Student, Florida State University

Amelia Pridemore

Doctoral Student, Florida International University

Jie Tao

Doctoral Student, University of North Texas

See page 107 for more information

Sunday, March 10

3:15 p.m. - 4:30 p.m.

Virginia

Improving Service Delivery in Public Sector Organizations in the U.S. and Abroad

MODERATOR

Pooja Paswan

Assistant Professor, Jamia Millia Islamia

PRESENTERS

Victoria Martin-Nammour

MPA Student, University of Central Florida

Assel Mussagulova

Doctoral Student, Nanyang Technological University, Singapore

Amy Owen

Doctoral Student, Tennessee State University

Shahrin Upoma

Doctoral Student, University of Texas at Dallas

See page 150 for more information

Monday, March 11

11:15 a.m. - 12:30 p.m.

Virginia

Public Human Resource Management Practices and Strategies

MODERATOR

Nuri Heckler

Doctoral Student, University of Colorado Denver

PRESENTERS

Edgar Bustos

Doctoral Student, Centro de Investigación y Docencia Económicas

Emmy Hicks

MPA Student, Louisiana State University

Joseph Maya Rodríguez

MPA Student, Rutgers University—Newark

Mustafa Sen

Doctoral Student, Mississippi State University

See page 169 for more information

NATIONAL PUBLIC SERVICE AWARDS

MONDAY, MARCH 11, 2019

9:30 a.m. – 11:00 a.m.

Grand Ballroom

Co-sponsored by ASPA and the National Academy of Public Administration, the National Public Service Awards honor individuals who make outstanding contributions and whose accomplishments are models of exemplary public service for those dedicated to the public good—now and in the future.

Thomas Becker



Thomas Becker is the academic director for The Judge Advocate General's (JAG) School, assuming those duties in August 2009. He oversees JAG School curriculum and faculty development, and engages with JAG Corps leadership to ensure the curriculum meets the Corps's needs.

Becker was commissioned in 1974 as a distinguished graduate of Air Force ROTC and designated a judge advocate in 1977. He served 22 years in the Air Force where his assignments included appellate military judge, associate deputy general counsel for the Department of Defense and staff judge advocate at two installations.

Becker retired in the grade of colonel in 1999 to accept then-Governor Tom Vilsack's appointment as state public defender of Iowa. After Vilsack left office, Becker served as an administrative law judge for the State of Iowa until accepting his current position.

Becker has a J.D. from Washburn University and an L.L.M. in constitutional and criminal law from The George Washington University. He is a member of the bars of the U.S. Supreme Court, the Iowa Supreme Court and the U.S. Court of Appeals for the Armed Forces.

Senator Barbara Favola



Senator Barbara A. Favola represents Virginia's 31st district, including parts of Arlington and Fairfax counties and a portion of Loudoun County. Prior to her election as a state senator, she served on the Arlington County Board for 14 years (1997-2011) and chaired that body three times.

During her service with the county, she was the board's leading advocate for children, youth and families; her

contributions to the community included establishing mental health services in the public schools.

Throughout her public life, Favola has been a vigorous supporter of universal human rights. In the Virginia Senate, she is focusing her legislative efforts on women's reproductive rights, health care access, K-12 education funding, workforce training, safety net programs, helping foster children, preventing domestic violence and sensible environmental policies. She also believes a living wage is essential for families and communities to thrive. She acknowledges that job creation and economic security are the cornerstones of a vibrant Commonwealth and a secure future.

Prior to Favola's elected life, she served as a presidential management intern and senior policy advisor at the U.S. Department of Health and Human Services. She also served on the House Budget Committee in the U.S. House of Representatives. She is the founder and managing director of Pathways to 21st Century Communities, a consulting group specializing in government relations and community outreach. In addition to her Senate duties, she serves on numerous Boards and Commissions, including the Advisory Committee for the Arlington YMCA and the Fairfax CASA Board.

Jessica Ross

Jessica Ross has been director of Washington County Public Library in Chatom, Alabama for 14 years. She recently received her PhD in communication and information sciences from the University of Alabama. In addition to professional service work, she volunteers as a leader in civic engagement, leadership initiatives and small business development through several community service organizations and is a mentor to many school-aged students across the county.

NATIONAL PUBLIC SERVICE AWARDS

Anthony A. Williams



Tony Williams, the former mayor of Washington, DC (1999-2007), is chief executive officer of the Federal City Council, an organization focusing the creative and administrative talents of Washington's business and professional leaders on major problems and opportunities facing

the District.

Williams is widely credited with leading Washington's comeback during his two terms as mayor, restoring our nation's capital's finances and improving the performance of government agencies, all while lowering taxes and investing in infrastructure and human services.

In addition to his duties with the Federal City Council, Williams is a senior advisor to King and Spaulding, LLP and serves on several company boards, as well as the boards of Urban Institute and the National Geographic Society. Prior to Federal City Council, he led the global government practice at the Corporate Executive Board in Arlington, Virginia. He also taught public finance and urban leadership as the William H. Bloomberg lecturer in public management at Harvard's John F. Kennedy School of Government, while coordinating programs for the Municipal Innovation Program at the Ash Center for Democratic Governance and Innovation.

Williams holds a bachelor's degree from Yale, a master's degree from the Harvard Kennedy School and a J.D. from Harvard Law School, as well as a number of awards and honorary degrees, including *Governing Magazine* Public Official of the Year in 1997. He is a National Academy of Public Administration fellow and former president of the National League of Cities.



ALL COMMUNITIES DESERVE GREAT LEADERSHIP

Make a greater impact and drive
positive change with our
Master's in Public Administration!

- Online and face-to-face instruction.
- 36 credit hour program
- Rolling Start Dates



TARLETON
STATE UNIVERSITY

Member of The Texas A&M University System

**DOYLE
PRINTING AD
HERE**

2019 SOCIETY AWARDS

Friday, March 8

3:00 p.m. Palm Court Ballroom

Presented at the Student and New Professional Summit

Wallace O. Keene Conference Scholarship Award

Awarded to students in public administration and public policy, the scholarships provide them financial assistance to attend the ASPA Annual Conference and expand their knowledge of the field.

Walter Mode Scholarship Award

This scholarship is given to a graduate student who is an ASPA member and demonstrates a commitment to a career in public service.

Saturday, March 9

3:15 p.m. Independence

Presented at the Section Leadership Meeting

Oveta Culp Hobby Chapter/Section Training Award

This award recognizes a Chapter or Section for activities during the year that provide professional development to members through planned activities.

Patricia J. Yearwood Chapter/Section Newsletter Award

The award is given annually to recognize newsletters as a vital means of communication and service offered to Chapter and Section members.

Sunday, March 10

10:00 a.m. Grand Ballroom

Presented during the Elliot Richardson Lecture

John W. Gaston Award for Excellence in Public Service Management

This award is presented to a public manager for excellence in public service management, particularly in natural resource management or environmental protection.

Elmer B. Staats Lifetime Achievement Award for Distinguished Public Service

This award honors a public administrator's lifetime accomplishments and contributions to public service and ASPA.

11:45 a.m. District Ballroom

Presented at the Gloria Hobson Nordin Social Equity Award Luncheon

Equal Opportunity/Affirmative Action Exemplary Practice Award

This award honors an individual or organization that has made outstanding contributions to a more equal society.

Gloria Hobson Nordin Social Equity Award

This annual award recognizes lifetime achievement and effort in the cause of social equity.

1:30 p.m. Grand Ballroom

Presented at the Public Service Plenary

Public Integrity Award

This award acknowledges an individual or organization that has made outstanding contributions to responsible conduct in public service.

Paul P. Van Riper Award for Excellence and Service

This award honors an individual who has made significant contributions to both the academic and practitioner communities of public administration. It is sponsored by the ASPA Endowment.

4:30 p.m. Grand Ballroom

Presented at the Global Public Administration Plenary and International Assembly

H. George Frederickson PA TIMES Best Article Award

This award recognizes the author of the PA TIMES article judged most informative, provocative, creative and well written.

International Public Administration Award

This award honors a distinguished international scholar or practitioner for contributions to public administration in other nations.

Monday, March 11

9:30 a.m.

Grand Ballroom

Presented at the Donald C. Stone Lecture

National Public Service Award

These awards honor individuals whose outstanding contributions and accomplishments are models of public service within and outside the work environment.

Donald C. Stone Award

This award honors an ASPA member who has contributed outstanding service to the Society.

Dwight Waldo Award

This award honors an individual who has made outstanding contributions to the professional literature of public administration over an extended career.

Public Administration Review Awards

Louis Brownlow Award

Presented to the author of the best *Public Administration Review* article written by a practitioner.

Laverne Burchfield Award

Presented to the author of the best book review in a 2018 volume of *Public Administration Review*.

William E. Mosher and Frederick C. Mosher Award

Presented to the author of the best *Public Administration Review* article written by an academic.

Chester Newland Award

Presented for the best commentary by a practitioner in *Public Administration Review*. The best commentary illuminates the significance of an article and adds value for readers by interpreting the article in light of the commentator's experience.

7:30 p.m.

Palm Court Ballroom

Presented during the President's Reception

Outgoing National Council Awards

Presented to departing members of the National Council whose terms end in March 2019.

Meet the Glenn College's newest faculty members

The John Glenn College of Public Affairs at The Ohio State University is pleased to welcome six new faculty members whose unique expertise and experience add tremendous value to our research capability and undergraduate, graduate and professional programs.



THE OHIO STATE UNIVERSITY

JOHN GLENN COLLEGE OF PUBLIC AFFAIRS



Jennifer Garner

Food Policy, Performance Measurement & Program Evaluation, Social Policy



Darrick Hamilton

Stratification Economics Economic and Social Policy Race, Ethnicity and Colorism



Andrea Headley

Criminal Justice Administration, Public Administration & Management



Jim Landers

Economic Policy, Local & State Government Policy, Public Budgeting and Finance



Greg Moody

Economic Policy, Health Policy, Public Administration & Management



Chris Rea

Environmental Policy, Regulation Policy, Social Policy

2019 SECTION AWARDS

The following is a list of awards presented by ASPA's Sections in recognition of individual and organizational contributions to the public sector. Please see the awards brochure for this year's honorees.

Center for Accountability and Performance (CAP)

Emerging Leaders Award

This award recognizes individuals who are actively implementing performance management systems, innovating new practices and promoting the importance of performance and accountability within their governments and communities.

Harry Hatry Distinguished Performance Measurement and Practice Award

This award recognizes an individual whose outstanding teaching, education, training and consultation in performance measurement have made a significant contribution to the practice of public administration.

Organizational Leadership Awards

This award recognizes outstanding applications of a systems approach to performance measurement that has resulted in a culture change, sustained improvements and demonstrated positive effects on government performance and accountability.

Joseph Wholey Distinguished Scholarship Award

This award recognizes outstanding scholarship on performance in public and nonprofit organizations. The recipient makes a significant contribution to advancing knowledge in a scholarly journal about the development, implementation, use and impact of performance measurement.

LGBT Advocacy Alliance (LGBT)

Published Article Award

This award is presented to the author or coauthor of the best paper published in 2018 that supports the Section's mission in a field-related journal.

Visionary Award

This award recognizes the unique characteristics of an individual to envision a future that would be diverse, inclusive and equitable. True visionaries are not part of the herd and their solutions are not always popular. They stand out with their strong beliefs and hold steadfast to their guiding principles, even in the face of adversity. They are ahead of their time.

Section for Women in Public Administration (SWPA)

Joan Fiss Bishop Leadership Award

Established in 1985, the award recognizes an honoree who, by example and action, has promoted increased participation of women in the public service profession; exhibited a defined contribution to increased involvement in the public sector; shown innovative leadership and accomplished professionalism in their public service career; and made a commitment to the profession through current or past ASPA membership.

Marcia P. "Marcy" Crowley Service to SWPA Award

Originally established in 1991 and rededicated in 2007, the award recognizes an honoree for outstanding service to SWPA, service to the Section for several years and for making a demonstrated impact on the Section's work. The honoree must be a Section member in good standing to receive the award.

Julia J. Henderson International Award

Originally established in 2007, the award recognizes an honoree for demonstrated commitment to international public administration, in particular, or to international public service in general by a lifetime of public service; or to careers in international public administration and public service. The honoree is not required to be an ASPA or SWPA member.

Rita Mae Kelly Distinguished Research Award

Originally established in 1991, the award recognizes an honoree for research contributions to gender-related issues; performing research on an issue(s) significant to women's role in public administration; and making an impact through research on women's lives. The honoree is not required to be an ASPA or SWPA member.

SWPA Conference Scholarship

These scholarships help defray the cost of attending ASPA's Annual Conference.

Section on Chinese Public Administration (SCPA)

Marc Holzer Best Article Award

This award recognizes the top article published in *Public Performance and Management Review* during 2018.

Ph.D. Student Best Paper Award

This award recognizes the best paper presented at the Marc Holzer Public Performance Symposium, held during the ASPA Annual Conference.

Section on Complexity and Network Studies (SCNS)

Sam Overman Best Paper Award

This award recognizes scholarly work that makes a significant contribution to the network or complexity literature and holds practical relevance to the public administration field. It is presented annually at the Section's business meeting and comes with a cash prize.

Section on Democracy and Social Justice (SDSJ)

Best Article Award

This award recognizes an outstanding peer-reviewed journal article published in the prior year that examines issues of democracy and social justice.

Best Book Award

This award recognizes an outstanding book published in the previous calendar year that examines issues of democracy and social justice.

Section on Effective and Sound Administration in the Middle East (SESAME)

Distinguished Achievements and Leadership in Public Administration Scholarship or Practice in the Middle East Award

This award recognizes significant and sustained contributions to public administration in and for the Middle East-North Africa region through scholarship, leadership and/or practice over an extended period of time.

Section on Emergency and Crisis Management (SECM)

Dissertation Award

This award supports dissertation research in emergency and crisis management performed by Ph.D. candidates who have successfully defended their proposal but do not have a completed dissertation.

William Petak Award

This award recognizes an outstanding paper in emergency and crisis management.

Section on Environmental and Natural Resources Administration (SENRA)

Best Graduate Paper Award

This award encourages original graduate-level research that expands our understanding of a problem or issue in environmental or natural resource administration; it helps defray the cost of participation in ASPA for graduate students. The award comes with a cash prize and a certificate of recognition presented at the ASPA Annual Conference. Winning papers also will be published in the SENRA newsletter.

Section on Ethics and Integrity in Governance (SEIGOV)

Lifetime Achievement Award

This award recognizes SEIGOV members whose extraordinary contributions to the furtherance of the Section's goals throughout their careers merit special acknowledgment. The award may recognize more than one individual annually and is presented during the Section's business meeting.

National Exemplars of Ethics and Integrity in Public Service

Section members may nominate individuals or groups whose exemplary ethics and integrity in public service have advanced the Section's mission. Honorees receive a personalized certificate and a one-year ASPA and SEIGOV membership.

2019 SECTION AWARDS

Public Integrity Awards

Scholars whose works were published in *Public Integrity* in 2018, Volume 20, are recognized in several categories: Best Article, Best Guest Editorial and Best Book/Film Review. Winners are selected based upon the perceived impact of the article in developing the theoretical, empirical and applied literatures on ethical issues affecting society, especially those that introduce new discourse to the field.

Student Paper of the Year Award

Annually, SEIGOV invites students in public affairs and public policy graduate programs to submit, or for faculty to nominate, student research papers authored during the previous year on any public or administrative ethics topic. Submissions are peer reviewed and judged for their quality, methodology, importance and policy implications, as well as clarity in writing. The winning submission is announced in media publications and its author is awarded a plaque of recognition from the Section during the ASPA Annual Conference.

Section on Intergovernmental Administration and Management (SIAM)

Donald C. Stone Best Student Paper Award

This award recognizes an exceptional student research paper on a question related to intergovernmental relations and management. The award is accompanied by a cash prize to assist the winner with ASPA Annual Conference attendance.

Donald C. Stone Practitioner Award

This award recognizes significant contributions to the practice of intergovernmental relations and management over a substantial period of time.

Donald C. Stone Scholar Award

This award recognizes significant contributions to the study of intergovernmental relations over a substantial period of time.

Section on International and Comparative Administration (SICA)

Col Award for Outstanding SICA Leadership

This award is offered to SICA members who have demonstrated strong commitment and made active leadership contributions to SICA's mission. It is named after Jeanne Marie Col and presented annually at the Section's business meeting.

David Gould Scholarship

This scholarship offers graduate students in the fields of public administration, public policy and/or international development support to attend the ASPA Annual Conference. Honorees receive a stipend and a free registration for the SICA symposium.

Fred Riggs Award for Outstanding Researcher

This award recognizes those who have made significant substantial and widely recognized contributions to the conceptual, theoretical or operational development of international, comparative or development administration. It is named in honor of Fred Riggs, a pioneer in these fields and a founder of the Section.

Section on Korean Public Administration (SKPA)

Junior Asian Scholarship Award

This award recognizes East Asian graduate students whose papers are accepted for presentation, or graduate students who will present papers on East Asia-related topics at the ASPA Annual Conference.

Section on Personnel Administration and Labor Relations (SPALR)

Book Award

This award recognizes an outstanding book in the field of public human resources management published between 2016 and 2018.

Dissertation Award

This award supports dissertation research performed by Ph.D. candidates in the area of public/nonprofit human resource management. The award comes with a cash prize and will be presented during the Section's business meeting at the ASPA Annual Conference.

Outstanding Scholar Award

This award recognizes individuals who have demonstrated an exemplary record of research, teaching and service in public human resources management.

Section on Professional and Organizational Development (SPOD)

Student Scholarships

These awards are designed to help facilitate learning to advance students' academic work around finding solutions to public organizational challenges, as well as to introduce students to the Section's work and encourage their long-term involvement in it.

Section on Public Administration Research (SPAR)

Best Book Award

This award recognizes a book that significantly contributes to public administration research.

Section on Public Law and Administration (SPLA)

Jurisprudence Champion Award

This award recognizes an individual who has made superior and notable contributions to the field of public law and administration that reflect social change.

Stellar Practitioner Award

This award recognizes an individual who has made effective and compelling contributions to the practice of public law and administration that, over time, have impacted how public administrators implement public law.

Section on Public Performance and Management (SPPM)

Best Article Award

This award recognizes the top article published in *Public Performance and Management Review* in 2018.

Best Paper Award

This award recognizes the best paper presented at the Section's symposium, held during the ASPA Annual Conference.

Section on Science and Technology in Government (SSTIG)

Digital Governance Junior Scholar Award

This award recognizes a junior scholar who has made a substantive contribution to improving our understanding of how to best utilize information and communication technology to improve public governance and public service.



Founded in 1979, the **Section on Personnel Administration and Labor Relations (SPALR)** represents a diverse community of **human resource professionals** from around the world dedicated to applying **merit-based principles** and encouraging **diversity** in public and nonprofit sectors; promoting **positive labor-management relationships**; advancing and expanding the knowledge of the field through research and scholarship; connecting theory, research, and practice in human resource management and policy to improve the effectiveness of public services; recognizing the contributions of public human resource professionals to quality public service; and promoting the importance of human resource management as a fundamental part of public and nonprofit organizations, as well as public administration education.

To fulfill its mission, SPALR sponsors panels, workshops and symposia at the annual ASPA national conference to provide opportunities for members to network and exchange ideas. Additionally, SPALR has developed several task forces to study important personnel and labor relations policy issues. These task forces have helped to forge ASPA positions and inform policy makers.

NETWORKING EVENTS

Join your conference friends and peers for a series of receptions hosted and generously supported by universities, sponsors and other organizations. These networking events are open to all attendees.

Sunday, March 10

6:00 p.m. - 7:00 p.m.
Wiley Exhibit Hall Reception
State and East Rooms

6:30 p.m. - 7:30 p.m.
Graduate School of Public and International
Affairs, University of Pittsburgh Reception
Senate

University of Southern California Sol Price
School of Public Policy Reception
Rhode Island

Women in the Public Sector, the MPA PPA and
MPA IO Programs and Department of Public
Management at John Jay College Reception
Virginia

Monday, March 11

6:30 p.m. - 7:30 p.m.
Brigham Young University Ice Cream Social and
Founders' Fellows Recognition Reception
Pennsylvania

National Public Service Awards Reception
New York

CU Denver, UCCS, CSU and Colorado Chapter of
ASPA Reception
(RSVP Required)
North Carolina

MPA in Public Policy and Administration

The Master of Public Administration program in Public Policy and Administration at John Jay College of Criminal Justice prepares students for careers in public and independent organizations as managers, analysts and leaders. This program is designed for individuals who seek the highest ideals of citizenship and public service while developing a commitment to integrity, accountability, transparency, equity, and fairness. The program offers specializations in Management and Operations, Human Resources Management, Law and Public Management, Criminal Justice Policy and Administration, Emergency Management, Court Administration and Urban Affairs.

JOHN JAY COLLEGE OF CRIMINAL JUSTICE
DEPARTMENT OF PUBLIC MANAGEMENT

CU NY
THE GREATEST URBAN UNIVERSITY IN THE WORLD

MPA in Inspection and Oversight

This program is designed for individuals who seek to pursue the highest ideals of public service by gaining an in-depth understanding of citizenship and public service, and the accountability, transparency and equity required in order to effectively serve as an inspection and oversight professional. The program offers specializations in Forensic Accounting, International Inspection and Oversight, Investigation and Operational Inspection, Organizational Assessment and Monitoring, Law and Inspection and Oversight, and Independent and Contractual Inspection and Oversight.

Join us at the **John Jay College Reception** hosted by Women in the Public Sector, The MPA PPA and MPA IO Programs, and the Department of Public Management at John Jay College
Date/Time: Sunday, March 10, 2019 6:30 PM - 7:30 P M

MPA Director **Welcome our New Faculty!**

Elaine Yi Lu, PhD Warren Eller, PhD Henry Smart, PhD Melissa McShea, PhD

@jjaypublicmanagement
@jjaypublicmgmt

ASPA

TRACKS

Global Public Administration

Infrastructure

Public Finance

Public Service

Social Equity

FRIDAY SESSIONS

#ASP2019



The focal point for public affairs education, research, and public service:

THE TRACHTENBERG EXPERIENCE

12 Current faculty members
are National Academy of
Public Administration
(NAPA) Fellows

New faculty awarded
outstanding dissertation awards **2**
(from NASPAA and the Council of Graduate Schools)

Trachtenberg School
of Public Policy
& Public Administration

THE GEORGE WASHINGTON UNIVERSITY

Academics and practitioners who
came to campus for the
*Public Administration
Review (PAR)* Symposium
on "Behavioral Approaches
to Bureaucratic Red Tape and
Administrative Burden" in May

80

22 academic journals featuring
editors and editorial board
members from our faculty

more good news at www.tspppa.gwu.edu

TRACKS: ● Public Finance ● Infrastructure ● Social Equity ● Public Service ● Global

SESSION	TIME	Room
ASPA Registration Open	7:00 a.m. – 5:00 p.m.	Promenade Foyer
● Presidential Panel–Public Administration Advancing Rule-Ordered Institutions in Asia (<i>Global Public Administration Focus</i>)	8:00 a.m. – 9:15 a.m.	Chinese Ballroom
● Digital Governance: International Developments	8:00 a.m. – 9:15 a.m.	New Jersey
● Fostering Effective and Accountable Governance in Africa	8:00 a.m. – 9:15 a.m.	North Carolina
● Financing Public and Nonprofit Governance	8:00 a.m. – 9:15 a.m.	New York
● Local Governments: Managing Service Delivery in an Era of Decreasing Resources	8:00 a.m. – 9:15 a.m.	Massachusetts
● Equity and Performance in Public Health and Public Reform Systems	8:00 a.m. – 9:15 a.m.	Senate
● Diversity in Research Contexts, Perspectives and Methods	8:00 a.m. – 9:15 a.m.	Virginia
Student and New Professional Summit	8:00 a.m. – 3:15 p.m.	Palm Court Ballroom
Fred Riggs Symposium	8:00 a.m. – 6:45 p.m.	New Hampshire and Maryland
Deil Wright Symposium	8:45 a.m. – 4:30 p.m.	Pennsylvania
ASPA Endowment Board Meeting	9:00 a.m. – 11:30 a.m.	Democracy
● Presidential Panel–Data Analytics (<i>Public Service Focus</i>)	9:30 a.m. – 10:45 a.m.	Chinese Ballroom
● Employee Turnover in Public Organizations	9:30 a.m. – 10:45 a.m.	Virginia
● The Changing Face of Public Procurement and Public-Private Partnerships	9:30 a.m. – 10:45 a.m.	Massachusetts
● Contracting as a Mechanism to Build Sustainable Communities and Achieve Accountability	9:30 a.m. – 10:45 a.m.	Senate
● Innovative Capacity Building for Global Collaboration	9:30 a.m. – 10:45 a.m.	North Carolina
● Global Perspectives on Public Administration Education	9:30 a.m. – 10:45 a.m.	New Jersey
● Addressing the Larger Picture on the Effects of Superstorms: A National Crisis	9:30 a.m. – 10:45 a.m.	South Carolina
● Presidential Panel–Revitalizing the Middle Class: Workforce Issues (<i>Public Service Focus</i>)	11:00 a.m. – 12:30 p.m.	Chinese Ballroom
L. Frances Liddell COMPA Student Policy Debate	12:00 p.m. – 2:00 p.m.	Virginia
● Presidential Panel–The Buck Stops Here: How Federal Leaders Can Reduce Improper Payments (<i>Public Finance Focus</i>)	12:45 p.m. – 2:00 p.m.	Chinese Ballroom
● Many State and Local Government Workers Do Not Have Social Security Coverage; Should We Care?	12:45 p.m. – 2:00 p.m.	North Carolina
● Importance of Data Quality in Performance Management	12:45 p.m. – 2:00 p.m.	New York
● Pre- and Post-Disaster Financial Management	12:45 p.m. – 2:00 p.m.	Massachusetts
● Public Service Innovation	12:45 p.m. – 2:00 p.m.	New Jersey
● NISPAcee Panel–Three Decades of Reform in Central and Eastern Europe and Central Asia: What Has Been Achieved?	12:45 p.m. – 2:00 p.m.	Senate
ASPA National Council Meeting	1:00 p.m. – 3:00 p.m.	South Carolina

MARCH 8 Friday Sessions

TRACKS: ● Public Finance ● Infrastructure ● Social Equity ● Public Service ● Global

SESSION	TIME	Room
● Presidential Panel—Assessing the Trump Administration’s Management Agenda: A Media Panel (<i>Public Service Focus</i>)	2:15 p.m. – 3:30 p.m.	Chinese Ballroom
Founders’ Fellows Panel—Promoting Excellence in Education and Nonprofit Organizations	2:15 p.m. – 3:30 p.m.	Virginia
● Comparative Public Finance around the World	2:15 p.m. – 3:30 p.m.	New York
● Innovative Revenue Generation in Public Administration	2:15 p.m. – 3:30 p.m.	Massachusetts
● Placing the Food System on the Public Administration Agenda	2:15 p.m. – 3:30 p.m.	North Carolina
● Perspectives on Governance	2:15 p.m. – 3:30 p.m.	New Jersey
● Law Enforcement and Community Relations	2:15 p.m. – 3:30 p.m.	Senate
● Presidential Panel—The Future has Begun: Using Artificial Intelligence to Transform Government (<i>Public Service Focus</i>)	3:45 p.m. – 5:00 p.m.	Chinese Ballroom
● Advancing Public Service through Teaching	3:45 p.m. – 5:00 p.m.	Senate
● Public Branding in a Globalized World	3:45 p.m. – 5:00 p.m.	New Jersey
● Nepotism: The Collapse of Public Administration and Democracy	3:45 p.m. – 5:00 p.m.	Virginia
● Sustaining a Fiscally Sound Public Sector Amid Challenges, Changes and Uncertainties	3:45 p.m. – 5:00 p.m.	North Carolina
● Tricks or Treats: The Impact of Incentives on Fiscal Health	3:45 p.m. – 5:00 p.m.	Massachusetts
● The Role of Procurement in Governance: Managing Relationships to Serve the Public Interest	3:45 p.m. – 5:00 p.m.	New York
NCAC Flash Networking Event	4:30 p.m. – 6:30 p.m.	Palm Court Ballroom
COMPA Meeting	5:30 p.m. – 6:30 p.m.	Virginia
<i>Public Performance Management Review (PPMR)</i> Journal Editors Meeting	5:30 p.m. – 6:30 p.m.	North Carolina
SWPA Meeting	5:30 p.m. – 6:30 p.m.	New York
SPAE Meeting	5:30 p.m. – 6:30 p.m.	Massachusetts
SEIGOV and <i>Public Integrity</i> Journal Editors Meeting	5:30 p.m. – 7:00 p.m.	New Jersey
SIAM Meeting	5:30 p.m. – 7:00 p.m.	Pennsylvania
SHARE and <i>Public Voices</i> Journal Editors Meeting	6:30 p.m. – 7:30 p.m.	South Carolina
Founders’ Fellows Orientation and Welcome Reception	6:30 p.m. – 7:30 p.m.	Senate

TRACKS: ● Public Finance ● Infrastructure ● Social Equity ● Public Service ● Global

Presidential Panel

8:00 a.m. - 9:15 a.m. Chinese Ballroom

Public Administration Advancing Rule-Ordered Institutions in Asia

Global Public Administration

MODERATOR

Marilyn Rubin

Distinguished Research Fellow, School of Public Affairs and Administration, Rutgers University—Newark

PRESENTERS

M. Jae Moon

Underwood Distinguished Professor, Yonsei University

Shui-Yan Tang

Distinguished Professor, University of Southern California

Kaifeng Yang

Dean and Professor, School of Public Administration and Policy, Renmin University of China

Panels

8:00 a.m. - 9:15 a.m. New Jersey

Digital Governance: International Developments

Global Public Administration

Endorsed By:

Association for Budgeting and Financial Management, International Chapter, Section on Public Administration Research and Section on Science and Technology in Government

PRESENTER

Seongho An

Doctoral Student, University of Pennsylvania
One-Two Punch: Online and Offline Nonprofit Advocacy

PRESENTERS/COAUTHORS

Marc Holzer

Distinguished Professor, Suffolk University
The Evolution of Digital Government: An International Comparison of Global Cities

Vaiva Kalesnikaite

Assistant Professor, The College at Brockport, The State University of New York
Does E-Governance Mitigate Public Corruption? Evidence from a Cross-National Study

Luis Luna-Reyes

Associate Professor, University at Albany, The State University of New York
Understanding Public Value Creation in the Delivery of Electronic Services

Aroon P. Manoharan

Associate Professor, University of Massachusetts—Boston
The Evolution of Digital Government: An International Comparison of Global Cities

Chul Hyun Park

Assistant Professor, University of Arkansas
Testing Impacts of E-Government on Corruption: A Global Perspective

COAUTHORS

Sukumar Ganapati

Associate Professor, Florida International University
Does E-Governance Mitigate Public Corruption? Evidence from a Cross-National Study

J. Ramon Gil-Garcia

Associate Professor and Research Director, University at Albany, The State University of New York
Understanding Public Value Creation in the Delivery of Electronic Services

Chao Guo

Associate Professor, University of Pennsylvania
One-Two Punch: Online and Offline Nonprofit Advocacy

Koomin Kim

Doctoral Student, Florida State University
Testing Impacts of E-Government on Corruption: A Global Perspective

M. Jae Moon

Underwood Distinguished Professor, Yonsei University
The Evolution of Digital Government: An International Comparison of Global Cities

Milena Neshkova

Associate Professor and Managing Editor, Florida International University
Does E-Governance Mitigate Public Corruption? Evidence from a Cross-National Study

Panels *(continued)*

Gabriel Puron Cid

Associate Professor, Centro de Investigación y Docencia Económicas
Understanding Public Value Creation in the Delivery of Electronic Services

Lisa Schmidhuber

Researcher, Johannes Kepler University
The Evolution of Digital Government: An International Comparison of Global Cities

Viviana Chiu-Sik Wu

Doctoral Student, University of Pennsylvania
One-Two Punch: Online and Offline Nonprofit Advocacy

8:00 a.m. - 9:15 a.m.

North Carolina

Fostering Effective and Accountable Governance in Africa

Global Public Administration

Endorsed By:

Section on African Public Administration

PRESENTERS

Peter Haruna

Professor, Texas A&M University
Building Professionalism in the Context of Africa's Agenda 2063: The Promise and Challenge of Change and Transformation

Rym Kaki

Associate Professor, University of Southern California
Toward an Integrated Accountability Assessment Framework: Comparative Lessons from the Development Finance Sector in North Africa

8:00 a.m. - 9:15 a.m.

New York

Financing Public and Nonprofit Governance

Public Finance

Endorsed By:

Section on Chinese Public Administration and Section on Public Administration Research

MODERATOR/DISCUSSANT

David Hai Guo

Associate Professor, Florida International University

PRESENTER

Qingqing Sun

Student, University of Maryland
Exploring the Relationship Between Revenue Sources and the Use of Funds in Chinese Philanthropic Foundations

PRESENTERS/COAUTHORS

Zeshan Cai

Professor, Lanzhou University
Institutional Analysis of Budget Performance Management Reform in China: A Review of Reform from 2003 to 2018

Jiandong Chen

Professor, Southwestern University of Finance and Economics
Research on the Deduction for Living Expenses of Individual Income Taxes in China

Wensheng He

Dean and Professor, Lanzhou University
Institutional Analysis of Budget Performance Management Reform in China: A Review of Reform from 2003 to 2018

Zeyu Jin

Professor, Southwestern University of Finance and Economics
Research on the Deduction for Living Expenses of Individual Income Taxes in China

Mei Ren

Inner Mongolia University of Finance and Economics
Public Financial Subsidy and Income of Farmers and Herdsmen: A Case Study on Rural and Pastoral Areas of Western China

COAUTHOR

Yinxi Liu

Inner Mongolia University
Public Financial Subsidy and Income of Farmers and Herdsmen: A Case Study on Rural and Pastoral Areas of Western China

Panels *(continued)*

8:00 a.m. - 9:15 a.m.

Massachusetts

Local Governments: Managing Service Delivery in an Era of Decreasing Resources

Public Finance

Endorsed By:

Section on Intergovernmental Administration and Management and Section on Procurement and Contract Management

MODERATOR/PRESENTER

Eric Zeemering

Associate Professor and MPA Director, University of Georgia

Burning Down the Walls: Managing Cost and Quality with Interlocal Agreements for Fire Service in California Cities

PRESENTERS

Michael Hayes

Assistant Professor, Rutgers University—Camden
Cutback Management Following the Great Recession: Is It Cost-Effective to Switch to a Four-Day School Week?

Lang (Kate) Yang

Assistant Professor, The George Washington University
Costs of State Budgetary Delays for Local Governments: The Case of Short-Term Debt

Pengju Zhang

Assistant Professor, Rutgers University
The Political Economy of Municipal Government Dissolution in New York: When Does a Village Become Unnecessary?

PRESENTERS/COAUTHORS

Shihyun Noh

Assistant Professor, The College at Brockport, The State University of New York
Alternative Service Delivery and Fiscal Health of Local Governments

Ji Hyung Park

Assistant Professor, James Madison University
Alternative Service Delivery and Fiscal Health of Local Governments

8:00 a.m. - 9:15 a.m.

Senate

Equity and Performance in Public Health and Public Reform Systems

Public Service

MODERATOR/PRESENTER

Andrew Ewoh

Professor, Texas Southern University
An Exploratory Analysis of Prison Reform and Recidivism in Houston and New York

PRESENTERS

Tanya Brinkley

Contributing Faculty, Walden University
Responsibility as We Don't Know It: Making "All Are Sheltered" a Possibility

Byung Hee Min

Instructor and Doctoral Student, Florida State University
Doing Well by Doing Good: Fulfilling Social Responsibility of For-Profit and Nonprofit Hospitals in Florida

PRESENTERS/COAUTHORS

Susan Camilleri

Assistant Professor, Elon University
Creating Alignment: An Exploratory Study of Post-Acute Network Development

Naya Farrell

MPA Student, Texas Southern University
An Exploratory Analysis of Prison Reform and Recidivism in Houston and New York

Ahreum Han

Doctoral Student, Florida State University
The Effects of a Health Governance-Focus Approach on Health Systems' Performance: USAID's Health Finance and Governance Project Case

COAUTHORS

Kathy Colville

Healthy Communities Director, Cone Health
Creating Alignment: An Exploratory Study of Post-Acute Network Development

Panels *(continued)*

Keon Hyung Lee

Professor and Director, Florida State University
Determinants of Technical Efficiency of Veterans Health Administration Hospitals
and
The Effects of a Health Governance-Focus Approach on Health Systems' Performance: USAID's Health Finance and Governance Project Case

8:00 a.m. - 9:15 a.m.

Virginia

Diversity in Research Contexts, Perspectives and Methods

Social Equity

Endorsed By:

Section on Democracy and Social Justice, Section on Health and Human Services Administration, Section on Public Administration Research and Students and New Administration Professionals Section

PRESENTERS

Yu-Che Chen

Professor and Director, University of Nebraska—Omaha
Systems Thinking and Modeling for Understanding and Solving Complex Social and Policy Challenges

Nuri Heckler

Doctoral Student, University of Colorado Denver
Whiteness and Masculinity in Quantitative Methodologies

Kimberly Nelson

Associate Professor, University of North Carolina—Chapel Hill
Public Health and Social Services at the Local Level

PRESENTER/COAUTHOR

Alisa Moldavanova

Assistant Professor, Wayne State University
Theories of Government and Civil Society in Non-Western Contexts: What Have We Learned about Their Applicability?

Student and New Professional Summit

8:00 a.m. - 3:15 p.m.

Palm Court Ballroom

MASTER OF CEREMONIES

Lindsey Evans

Assistant Professor, University of Louisville

8:00 a.m. - 8:30 a.m.

Getting Started

PRESENTER

Carol Rusaw

Retired

8:30 a.m. - 8:45 a.m.

Small Group Discussions: Personal Experiences

8:45 a.m. - 9:45 a.m.

Resumes and CVs: Selling Yourself

PRESENTERS

Alexander Henderson

Assistant Professor, Health Care and Public Administration, Long Island University

Saltanat Liebert

Associate Professor, Virginia Commonwealth University

William Shields, Jr.

Executive Director, American Society for Public Administration and Adjunct Professor, American University

9:45 a.m. - 10:10 a.m.

Cover Letters: Why Do They Matter?

PRESENTER

Sean McCandless

Assistant Professor, University of Illinois—Springfield

10:30 a.m. - 11:00 a.m.

The Job Search

PRESENTERS

Rashmi Chordiya

Assistant Professor, Institute of Public Service, Seattle University

Student and New Professional Summit *(continued)*

Deborah Eichhorn

Recruitment Program Manager, Human Capital Office,
U.S. Government Accountability Office

11:00 a.m. - 11:10 a.m.

Small Group: Job Search Resources

11:10 a.m. - 12:00 p.m.

The Interview

PRESENTER

J. Paul Blake

District IV Representative, ASPA National Council

1:00 p.m. - 1:30 p.m.

Networking: More Than Happy Hours and Business Cards

PRESENTERS

Amanda Olejarski

Associate Professor, West Chester University

Kitty Wooley

Retired, Senior Fellows and Friends

1:30 p.m. - 3:00 p.m.

Career Roundtables

3:00 p.m. - 3:15 p.m.

Awards Presentation and Closing Remarks

PRESENTER

Christopher Pierce

ASPA Student Representative

Fred Riggs Symposium

8:00 a.m. - 6:45 p.m.

New Hampshire and
Maryland

Endorsed By:

Section for International and Comparative Administration

The following data was provided by the Section.

8:00 a.m. - 8:25 a.m.

New Hampshire

Welcome

M. Shamsul Haque

Chair, Section on International and Comparative
Administration, National University of Singapore

Kim Moloney

Chair, Riggs Symposium Committee; Chair-Elect, Section
on International and Comparative Administration,
Murdoch University

Jane Pisano

Professor, Price School of Public Policy, University of
Southern California

8:30 a.m. - 9:45 a.m.

New Hampshire

Perspectives on Education Reforms within Muslim Societies

MODERATOR/DISCUSSANT

Nadeen Makhoul

American University

DISCUSSANT/PRESENTER

Mohamed Alaa Abdel-Moneim

Cairo University

*Ideas, Ideology and Education Reform Proposals in
Egypt Since 2011*

PRESENTERS/COAUTHORS

Sara Konrath

Indiana University

*Empathy, Muslim Philanthropy and Advancing
Education Reform in Muslim Societies*

Nadeen Makhoul

American University

*Reconstructing Education Policy: A Look at the Role of
International Organizations in Setting Precedents in
Education Policy*

Fred Riggs Symposium *(continued)*

Shariq Siddiqui

Indiana University
The "Third Space": Rethinking Education Reform in Muslim Societies
and
Empathy, Muslim Philanthropy and Advancing Education Reform in Muslim Societies

COAUTHORS

Ahmed Al-Wani

International Institute of Islamic Thought
The "Third Space": Rethinking Education Reform in Muslim Societies

Cynthia Miller-Idriss

American University
The "Third Space": Rethinking Education Reform in Muslim Societies

Ilham Nasser

International Institute of Islamic Thought
The "Third Space": Rethinking Education Reform in Muslim Societies

Saulat Pervez

International Institute of Islamic Thought
Empathy, Muslim Philanthropy and Advancing Education Reform in Muslim Societies

8:30 a.m. - 9:45 a.m.

Maryland

Intersections of Politics, Administration and Governance

MODERATOR

Naim Kapucu

University of Central Florida

DISCUSSANT

Farhad Hossain

University of Manchester

PRESENTERS/COAUTHORS

Ricardo Bello-Gomez

Indiana University
Management in Context: The Moderating Effect of Party System on the Management-Performance Relationship in Colombia and Mexico

Suparna Dutta

Virginia Commonwealth University
Rural Women as Community Change-Makers: The Role of Increased Participation of Women in Grassroots Governance and Community Development Projects in South Asia

Andrew Podger

Australian National University
Positioning the Public Service for the Future: Learning from the Past and Predicting Future Requirements

Jason Rivera

Buffalo State, The State University of New York
Political Interference and Disaster Management: A Preliminary Investigation of Political Influence in the Gambia

Lina Vyas

The Education University of Hong Kong
A Neo-Institutional Perspective on Anti-Corruption Policy: China's Tiger Hunt and India's Demonetization Compared

Alfred Muluan Wu

National University of Singapore
A Neo-Institutional Perspective on Anti-Corruption Policy: China's Tiger Hunt and India's Demonetization Compared

Jia Shi

Jiaotong University
Using System Dynamics to Improve Public Participation in Policy Assessments

COAUTHORS

Claudia Avellaneda

Indiana University
Management in Context: The Moderating Effect of Party System on the Management-Performance Relationship in Colombia and Mexico

Atta Cessay

Buffalo State, The State University of New York
Political Interference and Disaster Management: A Preliminary Investigation of Political Influence in the Gambia

Xuesong Guo

Xi'an Jiaotong University
Using System Dynamics to Improve Public Participation in Policy Assessments

Fred Riggs Symposium *(continued)*

Xiangnan Hu

Xi'an Jiaotong University
Using System Dynamics to Improve Public Participation in Policy Assessments

Naim Kapucu

University of Central Florida
Using System Dynamics to Improve Public Participation in Policy Assessments

Johabed Olvera

Indiana University
Management in Context: The Moderating Effect of Party System on the Management-Performance Relationship in Colombia and Mexico

Aminata Shah

Towson University
Political Interference and Disaster Management: A Preliminary Investigation of Political Influence in the Gambia

10:00 a.m. – 11:15 a.m. New Hampshire

Development Policy and Management: Global Perspectives

MODERATOR/COAUTHOR

Farhad Hossain

University of Manchester
Environmental Sanitation as a “Wicked Problem”: Issues Affecting Actors’ Relations in Environmental Policy Implementation in Ghana, Public Service Provision for Refugees: Perspectives from Syrian Refugees in Turkey, Infrastructure Development and Public-Private Partnerships in Developing Countries: Lessons Drawn from Ghana and Nigeria
and
Examining the Inexplicable Causes of Dysfunctional Behaviors in the Ghanaian Public Service: From the Perspectives of Social Capital and Agency Theories

MODERATOR/PRESENTER/COAUTHOR

Anthony S. Kumasey

University of Professional Studies, Ghana
Examining the Inexplicable Causes of Dysfunctional Behaviors in the Ghanaian Public Service: From the Perspectives of Social Capital and Agency Theories

DISCUSSANT

M. Shamsul Haque

National University of Singapore

PRESENTERS/COAUTHORS

Franklin Yayra Adorsu-Djentuh

University of Manchester
Environmental Sanitation as a “Wicked Problem”: Issues Affecting Actors’ Relations in Environmental Policy Implementation in Ghana and Infrastructure Development and Public-Private Partnerships in Developing Countries: Lessons Drawn from Ghana and Nigeria

Emrah Atar

University of Manchester
Public Service Provision for Refugees: Perspectives from Syrian Refugees in Turkey

Irene Nafisatu Okhade

University of Manchester
Infrastructure Development and Public-Private Partnerships in Developing Countries: Lessons Drawn from Ghana and Nigeria

Abu Elias Sarkar

University of Sharjah
Political Will as an Enabler of Public Management Reform: Evidence from the United Arab Emirates

COAUTHORS

Issifu Abdulai Amadu

University of Manchester
Environmental Sanitation as a “Wicked Problem”: Issues Affecting Actors’ Relations in Environmental Policy Implementation in Ghana

Osama Abufarraaj

University of Manchester
Public Service Provision for Refugees: Perspectives from Syrian Refugees in Turkey

Bridgit Kabah

University of Manchester
Environmental Sanitation as a “Wicked Problem”: Issues Affecting Actors’ Relations in Environmental Policy Implementation in Ghana

Aminu Mamman

University of Manchester
Infrastructure Development and Public-Private Partnerships in Developing Countries: Lessons Drawn from Ghana and Nigeria

Christopher J. Rees

University of Manchester
Public Service Provision for Refugees: Perspectives from Syrian Refugees in Turkey

Fred Riggs Symposium *(continued)*

10:00 a.m. - 11:15 a.m. Maryland

A Comparative Study of Quality of Government: Does It Matter in Public Service?

MODERATORS/DISCUSSANTS/COAUTHORS

Carl Dahlström

University of Gothenburg
Bureaucratic Structure and Public Service Provision: Evidence from Russia

M. Jae Moon

Yonsei University
A Comparative Study of the Effects of Decentralization on Public Trust
and
Information and Telecommunication Technologies and Quality of Government: A Comparative Analysis of Multi-Countries Panel Data

PRESENTER/COAUTHOR

Marina Nistotskaya

University of Gothenburg
Bureaucratic Structure and Public Service Provision: Evidence from Russia

COAUTHORS

Beomgeun Cho

University of Albany, The State University of New York
A Comparative Study of Citizens' Preferences of Policy Instruments: Does Quality of Government Matter?

Mehmet Demircioglu

National University of Singapore
Bureaucratic Impartiality and Quality of Public Services: Empirical Findings from a Study of 206 European Regions

Hyesong Ha

Yonsei University
Information and Telecommunication Technologies and Quality of Government: A Comparative Analysis of Multi-Countries Panel Data

Odkhuu Kh

Yonsei University
A Comparative Study of the Effects of Decentralization on Public Trust

Hanbit Kim

Yonsei University
A Comparative Study of the Effects of Decentralization on Public Trust

Taehyung Kim

Yonsei University
A Comparative Study of the Effects of Decentralization on Public Trust

Kohei Suzuki

Leiden University
Bureaucratic Impartiality and Quality of Public Services: Empirical Findings from a Study of 206 European Regions

11:30 a.m. - 12:45 p.m. New Hampshire

E-Government and Social Media in China, Southeast Asia and South Asia

MODERATOR

Yvonne Haigh

Murdoch University

DISCUSSANT

Veronica Junjan

University of Twente

PRESENTERS/COAUTHORS

Hoa Thai DaNang

Institute for Socioeconomic Development
Guarding Against Quiet Corruption: The Reverse Effect of Electronic Participation Policies in a Developing State

Hruza Filip

Masaryk University, Czech Republic
Social Media Usage in Local Governments: A Case Study of the Czech Republic

Shuhua Monica Liu

Fudan University
A Curse or Blessing? Use of Social Media in Emergency Response and Recovery in China

Makysova Lucia

Masaryk University, Czech Republic
Social Media Usage in Local Governments: A Case Study of the Czech Republic

Liting Panv

Fudan University, China
A Curse or Blessing? Use of Social Media in Emergency Response and Recovery in China

Suparna Soni

Buffalo State University, The State University of New York
E-Governance in Rural Local Self-Government in India

Fred Riggs Symposium *(continued)*

Anurag Kumar Srivastava

Petroleum University
Empowerment of Rural India through Digital Governance

COAUTHOR

Pandit Deendayal

Petroleum University
Empowerment of Rural India through Digital Governance

11:30 a.m. – 12:45 p.m.

Maryland

Impact of International Bureaucracies

MODERATOR

Nora Wagner

German University of Administrative Sciences

MODERATOR/PRESENTER/COAUTHOR

Michael W. Bauer

German University of Administrative Sciences
The Influence of International Public Administrations: A Comparative Approach

DISCUSSANTS

Meng-Hsuan Chou

NTU Singapore and Princeton University

Ali Farazmand

Florida Atlantic University

PRESENTERS/COAUTHORS

Shena Ashley

Urban Institute
Charting Three Trajectories for Globalizing Public Administration Research and Theory

Steffen Eckhard

University of Konstanz
International Organizations at the Street Level: Explaining the Staffing Mix of IGO Country Offices

Klaus H. Goetz

LMU Munich
UNRWA as a Hybrid International Public Administration: Resource Mobilization Between Geopolitics and the Provision of State-Like Services for Palestine Refugees

Rahel M. Schomaker

CUAS Villach
Public Administration and Internationalization: Status Quo and Ways Ahead

Jarle Trondal

University of California at Berkeley
“Not So Different after All”: Behavioral Patterns and Governance Dynamics in the Commission of the Economic Community of West African States

COAUTHORS

Jörn Ege

German University of Administrative Sciences
The Influence of International Public Administrations: A Comparative Approach

Xavier Fernández-i-Marín

LMU Munich
International Organizations at the Street Level: Explaining the Staffing Mix of IGO Country Offices

Stefan Gänzle

University of Agder
“Not So Different after All”: Behavioral Patterns and Governance Dynamics in the Commission of the Economic Community of West African States

Soonee Kim

Korean Development Institute
Charting Three Trajectories for Globalizing Public Administration Research and Theory

Nadja S. Kühn

University of Agder
“Not So Different after All”: Behavioral Patterns and Governance Dynamics in the Commission of the Economic Community of West African States

Harry Lambright

Syracuse University
Charting Three Trajectories for Globalizing Public Administration Research and Theory

Ronny Patz

LMU Munich
UNRWA as a Hybrid International Public Administration: Resource Mobilization Between Geopolitics and the Provision of State-Like Services for Palestine Refugees

Fred Riggs Symposium *(continued)*

Svanhildur Thorvaldsdottir

LMU Munich
UNRWA as a Hybrid International Public Administration: Resource Mobilization Between Geopolitics and the Provision of State-Like Services for Palestine Refugees

Nora Wagner

German University of Administrative Sciences
The Influence of International Public Administrations: A Comparative Approach

1:00 p.m. - 2:15 p.m. New Hampshire

Advancing Public Accountability under a Neoliberal State: Challenges to Democratic Governance?

MODERATORS/PRESENTERS/COAUTHORS

M. Shamsul Haque

National University of Singapore
Neoliberal Restructuring of Public Governance: Implications for Public Accountability in Asian Democracies

Paola Mattei

University of Milan
Merit Pay Policies in Italian Public Schools: Measurement and Conceptual Innovation of the 2015 Reform

DISCUSSANT

Aroon P. Manoharan

University of Massachusetts—Boston

PRESENTERS/COAUTHORS

Daniele Checchi

University of Milan
Merit Pay Policies in Italian Public Schools: Measurement and Conceptual Innovation of the 2015 Reform

Kilkon Ko

Seoul National University
Accountability to the Number for Organized Interests: A Critical Essay on the Idealism of Big Data and Citizens' Participations

Zeger van der Wal

National University of Singapore
Challenges to Public Service Motivation: How the Pursuit of External Rewards Impacts Public Servants' Work Attitudes in Kazakhstan

Wilson Wong

Chinese University of Hong Kong
Public Accountability Challenges under the Era of Big Data: Balancing the Competing Demands in Advancing Public Service

1:00 p.m. - 2:15 p.m.

Maryland

Challenging an Understanding of the "Administrative State"

MODERATOR

Kim Moloney

Murdoch University

DISCUSSANT

Alasdair Roberts

University of Massachusetts at Amherst

PRESENTERS/COAUTHORS

Meng-Hsuan Chou

NTU Singapore and Princeton University
Designing Interregional Cooperation through Policy Dialogues

Raymond Cox

University of Akron
Professional Administration: Recapturing Purpose and Method

Adrian Kay

Universiti Brunei Darussalam
Islamic Public Administration in Asia: Building a Conceptual Framework

Kim Moloney

Murdoch University
Administering the Transnational: Importance and "Interaction Flows"

B. Guy Peters

University of Pittsburgh
Populism and Public Administration: Confronting the Administrative State

Jon Pierre

University of Gothenburg
Populism and Public Administration: Confronting the Administrative State

Fred Riggs Symposium *(continued)*

2:30 p.m. – 3:45 p.m. New Hampshire

Immigration and Deportation Experiences of Non-United States Nationals

MODERATOR/PRESENTER/COAUTHOR

Peter Haruna

Texas A&M University

Analysis of Public Values Perspective in Immigration Policy

DISCUSSANT

Mehnaaz Momen

Texas A&M University

PRESENTERS

Rumki Basu

Jamia Millia Islamia

Right to Public Service Acts in India: Tools of Public Accountability and Ethical Governance

Pooja Paswan

Jamia Millia Islamia University

Governance and Public Service delivery in India: India's Attempt to Overcome Challenges in Public Service Delivery

Krishna Tummala

The Never Ending Fight Against Corruption in India

Shilpa Viswanath

Rutgers University

SMART City Initiatives in India: A Case of Devolution or Disenfranchisement?

PRESENTERS/COAUTHORS

Abraham Benavides

University of North Texas at Denton

The Administrative State and Immigration Policy

Selene Cruz

Texas A&M University

Compassionate Immigration Policy Advocacy

Jesus Pena

El Colegio de la Frontera Norte

Immigration and Deportation Experiences of Mexican Nationals

2:30 p.m. – 3:45 a.m.

Maryland

Public Service and Good Governance in India: Advancements, Challenges and Opportunities

MODERATOR

Aroon P. Manoharan

University of Massachusetts—Boston

DISCUSSANT

Meghna Sabharwal

University of Texas at Dallas

4:00 p.m. – 5:15 p.m.

New Hampshire

Comparative Public Human Resources Management: Reforms, Training and Recruitment

MODERATOR

Pooja Paswan

Jamia Millia Islamia University

DISCUSSANT

Rumki Basu

Jamia Millia Islamia University

PRESENTERS/COAUTHORS

Pallavi Awasthi

Florida International University

Lateral Entry Scheme: An Elixir to India's Ailing Civil Services

Rashmi Chordiya

Seattle University

Impact of New Public Management Reforms on Organizational and Employee Outcomes: A Multinational Comparative Study

Ning Kang

University of Manchester

Impact of Government Policies and Culture on Strategic HRM in Chinese Multinational Enterprises

Aroon P. Manoharan

University of Massachusetts—Boston

Public Administration Pedagogy in India

COAUTHORS

Franklin Yaya Adorsu-Djentuh

University of Manchester

Impact of Government Policies and Culture on Strategic HRM in Chinese Multinational Enterprises

Fred Riggs Symposium *(continued)*

Farhad Hossain

University of Manchester
Impact of Government Policies and Culture on Strategic HRM in Chinese Multinational Enterprises

Aminu Mamman

University of Manchester
Impact of Government Policies and Culture on Strategic HRM in Chinese Multinational Enterprises

Charlene M. L. Roach

University of West Indies
Impact of New Public Management Reforms on Organizational and Employee Outcomes: A Multinational Comparative Study

Meghna Sabharwal

The University of Texas at Dallas
Impact of New Public Management Reforms on Organizational and Employee Outcomes: A Multinational Comparative Study and Public Administration Pedagogy in India

Shilpa Viswanath

Rutgers University
Public Administration Pedagogy in India

4:00 p.m. - 5:15 p.m.

Maryland

Lessons Learned: Implementing Policy in Multiple Contexts

MODERATOR/PRESENTER

Veronica Junjan

University of Twente
European Semester Monitoring Effects upon the Implementation in European Union Member States: Integrating Migrant Labor Force

DISCUSSANT

Jean-Claude Garcia-Zamor

Florida International University

PRESENTERS

Renzo de la Riva Aguero

Indiana University
Opening the Black Box: Explaining the Effects and Mechanisms of Municipal Performance in Climate Change

Diana-Camelia Iancu

National University of Political Studies and Public Administration
The Governance of Refugee Integration Process in Romania: Evidence from the European Migrant Crisis

Saltanat Janenova

Nazarbayev University
Implementing Open Government in Central Asia

Yijia Jing

Fudan University
Subordinates or Partners: Government-Nonprofit Relationships in Public Service Delivery in China

Cristina M. Stanica

University of Delaware
Co-production Processes at the Local Level in Central and Eastern Europe

COAUTHOR

Mihai Ungureanu

National University of Political Studies and Public Administration
The Governance of Refugee Integration Process in Romania: Evidence from the European Migrant Crisis

5:30 p.m. - 6:45 p.m.

New Hampshire

Global Perspectives on Emotional Labor in the Public Service

MODERATOR

Mary Guy

University of Colorado Denver

PRESENTERS

Bolivia

Pamela Medina

University of Colorado Denver

China

Xiaojun Lu

Shanghai Jiao Tong University

South Korea

Hyun Jung Lee

MyongJi University

Pakistan

Aisha Azhar

University of Management and Technology

Fred Riggs Symposium *(continued)*

Philippines

Ador Torneo

De La Salle University

Rwanda

Sebawit Bishu

University of Colorado Denver

Taiwan

Chih-Wei Hsieh

City University of Hong Kong

United Kingdom

Sharon Mastracci

University of Utah

United States

Geri Miller-Fox

University of Utah

Methodological Issues in Comparative Research

Seung-Bum Yang

Konkuk University

5:30 p.m. - 6:45 p.m.

Maryland

Rapid Reforming Uzbekistan: Lessons for Comparative Administration

MODERATOR

Kim Moloney

Murdoch University

DISCUSSANT

Jennifer Murtazashvili

University of Pittsburgh

PRESENTERS

Nina Kolabashkina

World Bank

Citizen Engagement from the Top Down? Lessons from the Uzbekistan Experience

Kamila Mukhamedhanova

United Nations Development Programme

Public Administration Reform to Accelerate

Transformations in Uzbekistan

Shamshod Yunusov

Independent Expert

Self-Governance and Public Services: How Community Mobilization is Transforming Service Delivery Models in Uzbekistan

PRESENTERS/COAUTHORS

Rauf Salahodjaev

Centil Advisory

Local Governance and Public-Sector Reform in Uzbekistan

Shahnoza Tosheva

Centil Advisory

Local Governance and Public-Sector Reform in Uzbekistan

Deil Wright Symposium

8:45 a.m. - 4:30 p.m.

Pennsylvania

The following data was provided by the Section.

8:45 a.m. - 9:00 a.m.

Welcome and Introduction

DISCUSSANTS

Benoy Jacob

University of Nevada

Carl Stenberg

University of North Carolina

9:00 a.m. - 10:30 a.m.

The Role of Local Governments in the United States and European Regional Governance

MODERATOR/DISCUSSANT

Jay Rickabaugh

Appalachian State University

PRESENTERS/COAUTHORS

Austin Aldag

Cornell University

State Rules and Local Reality: Evidence from Interlocal Cooperation in New York State

Haris Alibašić

University of West Florida

Applying the Institutional Collective Action Framework to Intermunicipal Cooperation in Bosnia and Herzegovina

Deil Wright Symposium *(continued)*

Lachezar Anguelov

The Evergreen State College

Applying the Institutional Collective Action Framework to Intermunicipal Cooperation in Bosnia and Herzegovina

Astrid Molenveld

Erasmus University Rotterdam

Emergent and Mandated Regional Labor Market Collaborations: What Kind of Collaborative Logics Do They Establish?

Petra Ophoff

Netherlands School of Public Administration

Emergent and Mandated Regional Labor Market Collaborations: What Kind of Collaborative Logics Do They Establish?

Jitske van Popering-Verkerk

Erasmus University Rotterdam

Emergent and Mandated Regional Labor Market Collaborations: What Kind of Collaborative Logics Do They Establish?

Jay Rickabaugh

Appalachian State University

Local Autonomy and Development Policy in Mid-Sized Appalachian Regions in the United States

Thomas Skuzinski

Virginia Tech

Local Autonomy and Development Policy in Mid-Sized Appalachian Regions in the United States

Martijn van der Steen

Netherlands School of Public Administration

Emergent and Mandated Regional Labor Market Collaborations: What Kind of Collaborative Logics Do They Establish?

Geert Teisman

Erasmus University Rotterdam

Emergent and Mandated Regional Labor Market Collaborations: What Kind of Collaborative Logics Do They Establish?

Arwin van Buuren

Erasmus University Rotterdam

Emergent and Mandated Regional Labor Market Collaborations: What Kind of Collaborative Logics Do They Establish?

Mildred Warner

Cornell University

State Rules and Local Reality: Evidence from Interlocal Cooperation in New York State

10:45 a.m. - 12:15 p.m.

Environmental Federalism

MODERATOR/DISCUSSANT/PRESENTER/COAUTHOR

Jonathan M. Fisk

Auburn University

Law of the Intergovernmental Land: Pennsylvania's Act 13 and the Politics of Oil and Gas Management

PRESENTERS/COAUTHORS

Aaron Deslatte

University of Northern Illinois

Motivated Federalism: Citizen Ideology and Framing Performance in Intergovernmental Environmental Programs

AJ Good

Auburn University

Law of the Intergovernmental Land: Pennsylvania's Act 13 and the Politics of Oil and Gas Management

Nathaniel Harris Graham

Auburn University

Along the Coast: Intergovernmental Relations and Resiliency Planning in the Gulf Coast

Megan Heim-LaFrombois

Auburn University

Along the Coast: Intergovernmental Relations and Resiliency Planning in the Gulf Coast

Sam Houghteling

Colorado State University

"DOLA'ing" Out Grants: Understanding State-Local Grant Decisionmaking in Colorado

Soren Jordan

Auburn University

Law of the Intergovernmental Land: Pennsylvania's Act 13 and the Politics of Oil and Gas Management

Ryan J. Scott

Colorado State University

"DOLA'ing" Out Grants: Understanding State-Local Grant Decisionmaking in Colorado

Deil Wright Symposium *(continued)*

1:30 p.m. – 3:00 p.m.

Intergovernmental Collaboration

MODERATOR/DISCUSSANT

Benoy Jacob

University of Nevada—Las Vegas

PRESENTERS/COAUTHORS

Jered Car

University of Illinois

Analyzing the Effectiveness of Public Service Networks: Evidence from a Large N Study of Intergovernmental Agreements in Iowa

Richard Feiock

Florida State University

Collaboration at the Regional Level: An Institutional Collective Action Model of Collaborative Planning Among Metropolitan Planning Organizations

Victor Hugg

University of Illinois

Analyzing the Effectiveness of Public Service Networks: Evidence from a Large N Study of Intergovernmental Agreements in Iowa

Namhoon Ki

Florida State University

The Effect of Reputation on Collaborative Information Sharing Among Local Governments

Soyoung Kim

Seoul National University of Science and Technology

Collaboration at the Regional Level: An Institutional Collective Action Model of Collaborative Planning Among Metropolitan Planning Organizations

John Lubin

Florida State University

Collaboration at the Regional Level: An Institutional Collective Action Model of Collaborative Planning Among Metropolitan Planning Organizations

Rosemary O’Leary

University of Kansas

Helping Local Governments with a Tool to Aid in Collaborative Service Delivery Arrangements

Jose Cetina Sanchez

University of Illinois

Analyzing the Effectiveness of Public Service Networks: Evidence from a Large N Study of Intergovernmental Agreements in Iowa

Michael Siciliano

University of Illinois

Analyzing the Effectiveness of Public Service Networks: Evidence from a Large N Study of Intergovernmental Agreements in Iowa

David Swindell

Arizona State University

Helping Local Governments with a Tool to Aid in Collaborative Service Delivery Arrangements

3:15 p.m. – 4:15 p.m.

Roundtable Discussion: The Implications of Trump and the Mid-Term Elections on Intergovernmental Relationships

DISCUSSANTS

John Kincaid

Lafayette University

Brooks Rainwater

National League of Cities

4:15 p.m. – 4:30 p.m.

Closing

Presidential Panel

9:30 a.m. – 10:45 a.m.

Chinese Ballroom

Data Analytics

Public Service

MODERATOR

Mallory Bulman

Research and Evaluation, The Partnership for Public Service

PRESENTER

Andrew Feldman

Director, Public Service Practice, Grant Thornton

Panels

9:30 a.m. - 10:45 a.m.

Virginia

Employee Turnover in Public Organizations

Public Service

PRESENTERS

Saud Alotoaibi

Doctoral Student, University of North Texas
Employee-Job Fit and Intent to Leave in Saudi Public Organizations

Dongjin Oh

Doctoral Student, Florida State University
Effect of Teacher Turnover on Student Achievement

PRESENTERS/COAUTHORS

Alina Parbtani

Assistant Director and Doctoral Student, Florida International University
STEM in Federal Agencies: Impact on Turnover

Weijie Wang

Assistant Professor, University of Missouri—Columbia
Leader Experience, Turnover and the Performance of Public Organizations

COAUTHORS

Susannah Ali

Assistant Professor, Florida International University
STEM in Federal Agencies: Impact on Turnover

Rusi Sun

Assistant Professor, University of Michigan—Dearborn
Leader Experience, Turnover and the Performance of Public Organizations

9:30 a.m. - 10:45 a.m.

Massachusetts

The Changing Face of Public Procurement and Public-Private Partnerships

Public Finance

Endorsed By:

Section on Procurement and Contract Management

MODERATOR/COAUTHOR

John Morris

Professor, Old Dominion University
Multisector Administration in Stewardship Contracting: The Case of the United States Forest Service

PRESENTERS

Juanita Rendon

Lecturer, U.S. Naval Postgraduate School
Public Trust Failures and Ethical Issues: An Analysis of U.S. Navy Procurement

Kuan-Chiu Tseng

Associate Professor, National Taiwan Normal University
The Current Status of Development of Public-Private Partnerships in Taiwan

PRESENTERS/COAUTHORS

Kouliga Koala

Researcher, Old Dominion University
Multisector Administration in Stewardship Contracting: The Case of the United States Forest Service

Jianzhi Zhao

Assistant Professor, Fudan University
Does Government Punish Nonprofits for High Administrative Costs in Contracting Decisions?

COAUTHORS

Jiahuan Lu

Assistant Professor, Rutgers University—Newark
Does Government Punish Nonprofits for High Administrative Costs in Contracting Decisions?

Joshua Steinfeld

Assistant Professor, Old Dominion University
Multisector Administration in Stewardship Contracting: The Case of the United States Forest Service

9:30 a.m. - 10:45 a.m.

Senate

Contracting as a Mechanism to Build Sustainable Communities and Achieve Accountability

Public Finance

Endorsed By:

Section on Procurement and Contract Management

MODERATOR

Mohamad Alkadry

Professor, University of Colorado Denver

DISCUSSANTS

Sawsan Abutabenjeh

Assistant Professor, Mississippi State University

Panels *(continued)*

Rick Grimm

Chief Executive Officer, NIGP: The Institute for Public Procurement

PRESENTERS

Lachezar Anguelov

Assistant Professor, The Evergreen State College
Keeping It Local: The Impact of Public Contracting Practices on Community Economies and Employment

Daniel Bauer

Doctoral Student, Florida Atlantic University
Obtaining Efficiency through Green Public Procurement 360: Using Contract Incentives to Drive Green Bond Financing of Public-Private Partnerships

Ana-Maria Dimand

Doctoral Student, Florida International University
Understanding Driving and Hindering Factors of Green Public Procurement Practices in Local U.S. Governments

Evelyn Trammell

Doctoral Student, Florida International University
Representative Bureaucracy in Government Contracting: Examining Supplier Diversity Policy Decision and Implementation

PRESENTERS/COAUTHORS

Emily Boykin

Undergraduate Student, University of Florida
Scrutinizing Voluntary Ex-Ante Transparency Notices in the European Single Market: Evading Accountability?

Eric Prier

Professor, Florida Atlantic University
Scrutinizing Voluntary Ex-Ante Transparency Notices in the European Single Market: Evading Accountability?

COAUTHOR

Clifford McCue

Professor and BPM Program Coordinator, Florida Atlantic University
Scrutinizing Voluntary Ex-Ante Transparency Notices in the European Single Market: Evading Accountability?

9:30 a.m. - 10:45 a.m.

North Carolina

Innovative Capacity Building for Global Collaboration

Public Finance

Endorsed By:

Section on Effective and Sound Administration in the Middle East

PRESENTERS

Mohamed Hasan Al Sabba

Raed Bin Shams

President, MENAPAR and General Director, Bahrain Institute of Public Administration

Aziza Zembrani

Associate Professor and Chair, University of Texas at Rio Grande Valley

9:30 a.m. - 10:45 a.m.

New Jersey

Global Perspectives on Public Administration Education

Global Public Administration

Endorsed By:

Association for Budgeting and Financial Management, International Chapter, Section for Women in Public Administration, Section on Public Administration Education and Section on Public Administration Research

PRESENTER

Kalu Kalu

Distinguished Research Professor, Auburn University Montgomery
Knowledge Management and Change: Cognitive Competencies for a New Public Administration

PRESENTER/COAUTHOR

Bok Jeong

Assistant Professor, Kean University
Eastern and Western NPO/NGO Education in Public Administration: Comparison of South Korea and the United States

COAUTHORS

Kazuyuki Ishida

Professor, Kansai University
The Civil Service Exam and Public Administration Education: Comparing Tokyo and Seoul

Panels *(continued)*

Wonkang Lee

Director, Evaluation and Collaboration Division, Seoul Metropolitan Government
The Civil Service Exam and Public Administration Education: Comparing Tokyo and Seoul

9:30 a.m. - 10:45 a.m. South Carolina

Addressing the Larger Picture of the Effects of Superstorms: A National Crisis

Infrastructure

Endorsed By:

Section for Women in Public Administration and Section on Emergency and Crisis Management

MODERATOR

Philip Nufrio

Professor, Metropolitan College of New York

DISCUSSANT

Roseanne Mirabella

Professor, Seton Hall University

PRESENTERS

Beverly Cigler

Distinguished Professor Emerita, Penn State Harrisburg

Garret Graves

House of Representatives (LA-06), U.S. Congress

Presidential Panel

11:00 a.m. - 12:30 p.m. Chinese Ballroom

Revitalizing the Middle Class: Workforce Issues

Public Service

MODERATOR

Maria Aristigueta

Director, Biden School of Public Policy and Administration, University of Delaware

PRESENTERS

Heather Boushey

Executive Director, Washington Center for Equitable Growth

Stephanie Hoopes

National Director, United Way New Jersey ALICE Project

Mark Pisano

Professor of Practice of Public Administration, Price School of Policy, University of Southern California

Leland Ware

Louis. L. Redding Chair and Professor, Biden School of Public Policy and Administration, University of Delaware

L. Frances Liddell COMPA Student Policy Debate

12:00 p.m. - 2:00 p.m.

Virginia

Presidential Panel

12:45 p.m. - 2:00 p.m.

Chinese Ballroom

The Buck Stops Here: How Federal Leaders Can Reduce Improper Payments

Public Finance

MODERATOR

Dave Mader

Chief Strategy Officer, Deloitte & Touche

PRESENTERS

Cory Baumhardt

Improper Payments Manager, U.S. Department of Transportation

D.J. LaVoy

Deputy Assistant Secretary PIH, Real Estate Assessment Center

Panels

12:45 p.m. - 2:00 p.m.

North Carolina

Many State and Local Government Workers Do Not Have Social Security Coverage; Should We Care?

Public Finance

Endorsed By:

Section on Democracy and Social Justice and Section on Intergovernmental Administration and Management

MODERATOR/DISCUSSANT

Alex Brown

Research Manager, National Association of State Retirement Administrators

Panels *(continued)*

PRESENTERS

Chad Aldeman

Principal, Policy and Thought Leadership, Bellwether Education Partners

Uncovered: Social Security, Retirement Uncertainty and 1 Million Teachers

Sarah Holmes

Research Project Manager, National Bureau of Economic Research

Social Security Coverage for State and Local Government Workers: A Reconsideration

Laura Quinby

Research Economist, Center for Retirement Research at Boston College

Spillovers from State and Local Pensions to Social Security: Do Benefits for Uncovered Workers Meet Federal Standards?

Margie Shields

Assistant Director, U.S. Government Accountability Office

Inadequate Federal Oversight of State and Local Government Retirement Plans Puts Both the Government and Workers at Risk

12:45 p.m. - 2:00 p.m.

New York

Importance of Data Quality in Performance Management

Public Finance

Endorsed By:

Section on Democracy and Social Justice, Section on Public Administration Research and Section on Public Performance and Management

MODERATOR

Rakesh Mohan

Director, Office of Performance Evaluations, Idaho State Legislature

DISCUSSANT

Joe Wholey

Visiting Scholar, University of Delaware

PRESENTER

George Grob

President, Center for Public Program Evaluation

Examples of Organizations Using Effective Data Quality Approaches and Techniques

12:45 p.m. - 2:00 p.m.

Massachusetts

Pre- and Post-Disaster Financial Management

Infrastructure

Endorsed By:

Section on Emergency and Crisis Management

PRESENTERS

Karina Arias

Public Administrator, Universidad De Santiago De Chile

A Multi-Level Analysis of Innovation in Public Policies: The Case of the National Emergency Management Policy in Chile

Qing Miao

Assistant Professor, Rochester Institute of Technology

Natural Disasters, Public Housing and the Role of Disaster Aid

Ray Oman

Professor, University of the District of Columbia

Debt, Fiscal and Hurricane Issues in Puerto Rico and the United States Response

Manoj Shrestha

Associate Professor, University of Idaho

Community-Organization Networks and Community Sustainability

PRESENTER/COAUTHOR

Hyunwoo Lim

Doctoral Student, University of North Texas

Purchasing Disaster Insurance: Households' Risk Perception and Social Norms

COAUTHORS

Simon Andrew

Professor, University of North Texas

Purchasing Disaster Insurance: Households' Risk Perception and Social Norms

Kyungwoo Kim

Research Fellow and Adjunct Lecturer, University of North Texas

Purchasing Disaster Insurance: Households' Risk Perception and Social Norms

Jisun Ryu

Doctoral Student, University of North Texas

Purchasing Disaster Insurance: Households' Risk Perception and Social Norms

Panels *(continued)*

12:45 p.m. - 2:00 p.m.

New Jersey

Public Service Innovation

Public Service

Endorsed By:

Section for Women in Public Administration and Section on Public Administration Research

PRESENTERS

Kate McGovern

Professor—(Retired), State of New Hampshire Bureau of Education and Training
A Public-Sector Journey to Lean: Management for Operational Excellence

Morgan Vogel

Doctoral Student, University of Nebraska—Omaha
Public Service as a Vocation: A Practical Approach for Advancing Public Service

PRESENTERS/COAUTHORS

Ida Drury

Implementation and Workforce Specialist, University of Colorado Denver
Systems of Empowerment: Building a Concept of Trauma-Informed Public Management

Jaeyong Lee

Associate Research Fellow, Korea Research Institute for Local Administration
Linking Job Autonomy to Innovative Behavior: A Moderated Mediation Model of Job Satisfaction and Knowledge Sharing

Annie Miller

Assistant Research Professor, University of Denver
Systems of Empowerment: Building a Concept of Trauma-Informed Public Management

Maren Trochmann

Doctoral Student, University of Colorado—Denver
Systems of Empowerment: Building a Concept of Trauma-Informed Public Management

COAUTHORS

Myung Jin

Associate Professor, Virginia Commonwealth University
Linking Job Autonomy to Innovative Behavior: A Moderated Mediation Model of Job Satisfaction and Knowledge Sharing

Jaehye Park

Visiting Research Fellow, Korea Institute of Public Administration

Linking Job Autonomy to Innovative Behavior: A Moderated Mediation Model of Job Satisfaction and Knowledge Sharing

12:45 p.m. - 2:00 p.m.

Senate

NISPAcee Session—Three Decades of Reform in Central and Eastern Europe and Central Asia: What Has Been Achieved?

Global Public Administration

MODERATOR

Ludmila Gajdosova

Executive Director, NISPAcee

DISCUSSANT

Allan Rosenbaum

Professor, Public Administration and Director, Institute for Public Management and Center for Democracy and Good Governance, Florida International University

PRESENTERS

Roger Hamlin

Professor, Michigan State University

Diana-Camelia Iancu

Dean and Associate Professor of European Governance, National University of Political Studies and Public Administration

Cristina M. Stanica

Teaching Assistant, University of Delaware

PRESENTER/COAUTHOR

Saltanat Janenova

Assistant Professor, Nazarbayev University

COAUTHOR

Alikhan Baimenov

Chairman of Steering Committee, ACSH Astana Civil Service

Presidential Panel

2:15 p.m. - 3:30 p.m. Chinese Ballroom

Assessing the Trump Administration's Management Agenda: A Media Panel

Public Service

MODERATOR

Tom Shoop

Executive Vice President and Editor in Chief, *Government Executive Media Group*

PRESENTERS

Aaron Boyd

Senior Editor, Technology and Events, *Nextgov*

Charles M. Clark

Senior Correspondent, *Government Executive*

Eric Katz

Senior Correspondent, *Government Executive*

Katherine McIntire Peters

Deputy Editor, *Government Executive Media Group*

Founders' Fellows Panel

2:15 p.m. - 3:30 p.m. Virginia

Promoting Excellence in Education and Nonprofit Organizations

MODERATOR/PRESENTER

Cimone Philpotts

Doctoral Student, University of Delaware
Advocacy, Activism and the Academy

PRESENTERS

Christopher Burks

MPA Student, University of Alabama—Birmingham
How School District Secession Impacts the District Left Behind

Wendy Chen

Doctoral Student, George Mason University
Public Partnerships in STEM Education

Suparna Dutta

Doctoral Student, Virginia Commonwealth University
How Does Nonprofit Board Inclusion Impact Effectiveness

Nara Yoon

Doctoral Student, Syracuse University
The Drivers and Consequences of Nonprofit Board Interlocks

Panels

2:15 p.m. - 3:30 p.m. New York

Comparative Public Finance around the World

Public Finance

Endorsed By:

Association for Budgeting and Financial Management, International Chapter and Section on Chinese Public Administration

PRESENTERS

Jennifer Martinez

Doctoral Student, Portland State University
Mexico's Decentralization: Bridging the Contours of Remittances and Competitive Elections

Marcus Mauldin

Associate Professor and Assistant Dean, University of Tennessee—Chattanooga
A Rational/Technocratic Explanation of Local Economic Development Performance Agreement Use with Firms Receiving Incentives

Arwiphawee Srithongrung

Visiting Research Fellow, University of Illinois—Springfield
Citizen Satisfaction Surveys and Quantitative Data Analyses: Are They Useful for More Accurate Performance Budgets?

PRESENTERS/COAUTHORS

Frances Berry

Reubin O.D. Askew Eminent Scholar and Frank Sherwood Professor of Public Administration, Florida State University
Sustainable Governance and Collaboration: Co-Production and Social Enterprise Practices Internationally

Donwe Choi

Doctoral Student, Florida State University
Sustainable Governance and Collaboration: Co-Production and Social Enterprise Practices Internationally

Panels *(continued)*

Xiaohu Wang

Professor, City University of Hong Kong
Fiscal Transparency and Trust: An Exploratory Study on Baimiao Township-Level Government

COAUTHORS

Jiannan Wu

Distinguished Professor and Executive Vice Dean, Shanghai Jiaotong University
Fiscal Transparency and Trust: An Exploratory Study on Baimiao Township-Level Government

Bo Yan

Associate Professor, Xi'an Jiaotong University
Fiscal Transparency and Trust: An Exploratory Study on Baimiao Township-Level Government

2:15 p.m. - 3:30 p.m.

Massachusetts

Innovative Revenue Generation in Public Administration

Public Finance

MODERATOR/PRESENTER

Brian Beachkofski

Managing Director, Third Sector Capital Partners, Inc.
Trends and Opportunities in Pay for Success and Outcome-Oriented Contracting

PRESENTERS

Matt Bagwell

Assistant Professor, Tarleton State University
Going It Alone, Doing More with Little and Making It Work: Creative Revenue Generation Techniques by Local Governments

Stephanie Pink-Harper

Associate Professor, Southern Illinois University—Carbondale
Sources of Economic Growth Generation: An Examination of Enterprise Zone Policies to Promote Economic Sustainability

PRESENTERS/COAUTHORS

Hunter Hill

MPA Student, Florida State University
Stimulating Local Government's Continuing Innovation through Intergovernmental Grants: Evidence from the Energy Sector

Cynthia Lynch

Associate Professor, Hawaii Pacific University
Social Impact Bonds: An Experiment in Funding Intractable Social Problems

COAUTHORS

Richard Feiock

Professor, Florida State University
Stimulating Local Government's Continuing Innovation through Intergovernmental Grants: Evidence from the Energy Sector

Tian Tang

Assistant Professor, Florida State University
Stimulating Local Government's Continuing Innovation through Intergovernmental Grants: Evidence from the Energy Sector

Jessica Terman

Assistant Professor, George Mason University
Stimulating Local Government's Continuing Innovation through Intergovernmental Grants: Evidence from the Energy Sector

Kaifeng Yang

Dean and Professor, School of Public Administration and Policy, Renmin University of China
Stimulating Local Government's Continuing Innovation through Intergovernmental Grants: Evidence from the Energy Sector

2:15 p.m. - 3:30 p.m.

North Carolina

Placing the Food System on the Public Administration Agenda

Public Service

Endorsed By:

Section on Democracy and Social Justice

MODERATOR/PRESENTER

A. Bryce Hoflund

Associate Professor, University of Nebraska—Omaha
Reclaiming the Food System in Public Administration: Arguments for the Publicness of Food and Agricultural Issues

PRESENTERS

Rachel Emas

Assistant Teaching Professor and MPA Programs Director, Rutgers University—Newark
Community Food Systems: Calling on an Old Solution to Solve New Public Service Problems

Panels *(continued)*

B.J. Fletcher

Doctoral Student, University of Nebraska—Omaha
Food Insecurity: The Student Experience

John Jones

Agricultural Development Specialist, New Jersey State
Agriculture Development Committee
*Policy Intrapreneurship in Local Food System
Development*

Megan McGuffey

Doctoral Student, University of Nebraska—Omaha
*Exploring Food Policy Networks in Local-Level
Governance*

2:15 p.m. - 3:30 p.m.

New Jersey

Perspectives on Governance

Public Service

Endorsed By:

Section on Complexity and Network Studies and Section
on Democracy and Social Justice

PRESENTERS

Joseph Hafer

Doctoral Student, Penn State Harrisburg
*Developing the Theory of Pragmatic Governance
through the Use of Classic Grounded Theory
Methodology*

Stephen Hamill

Principal, Shared Leadership Group, LLC
*Broken Federalism, Shared Leadership and Public,
Private and Civic Actors Working Together on Public
Service Challenges*

Juniper Katz

Doctoral Student and Instructor, University of Colorado
Denver
*Bureaucracy's Role in Constituting Democracy: A Case
Study of U.S. Farm Policy Implementation*

PRESENTERS/COAUTHORS

Seong Kang

Assistant Professor, New Mexico State University
*Co-Producing Public Services: Citizen Perceptions, Race
and Neighborhood Context on Willingness to Co-Produce*

Alejandra Medina

Doctoral Student, University of Illinois—Chicago
Measuring the Quality of Agency Management

COAUTHORS

James Thompson

Associate Professor, University of Illinois—Chicago
Measuring the Quality of Agency Management

Brian N. Williams

Associate Professor, University of Virginia
*Co-Producing Public Services: Citizen Perceptions, Race
and Neighborhood Context on Willingness to Co-Produce*

2:15 p.m. - 3:30 p.m.

Senate

Law Enforcement and Community Relations

Social Equity

PRESENTER

Nissim Cohen

Department Head, Haifa University
*Why Do Street-Level Bureaucrats Risk Themselves for
Others? The Case of Israeli Police Officers*

PRESENTERS/COAUTHORS

Tayfun Ayazma

Doctoral Student, University of North Texas
*Community Policing in a New Era: The Impact of Citizen
Perception of Community Policing on Fear of Terrorism
and Resiliency*

James Brunet

Associate Professor and Director, North Carolina State
University
*Growing Militarization? Understanding the Public
Service Motivation of Police Officers*

COAUTHOR

Jeffrey Diebold

Assistant Professor, North Carolina State University
*Growing Militarization? Understanding the Public
Service Motivation of Police Officers*

Presidential Panel

3:45 p.m. - 5:00 p.m.

Chinese Ballroom

The Future has Begun: Using Artificial Intelligence to Transform Government

Public Service

MODERATOR

Mallory Bulman

Vice President, Research, The Partnership for Public
Service

Presidential Panel *(continued)*

PRESENTER

Dan Chenok

Executive Director, The IBM Center for The Business of Government

Panels

3:45 p.m. - 5:00 p.m.

Senate

Advancing Public Service through Teaching

Public Service

Endorsed By:

Section on Public Administration Education and Students and New Administration Professionals Section

MODERATOR

Rachel Emas

Assistant Teaching Professor and MPA Programs Director, Rutgers University—Newark

PRESENTERS

Gregg Buckingham

Former Manager, NASA and Lecturer, University of Central Florida

The Benefits of Integrative Learning Techniques in Undergraduate Public Administration Classes

Pamela Dunning

Associate Professor, Troy University

Public Administration Research: Relevancy to Teaching and Learning

Tammy Esteves

Assistant Professor, Troy University

E-Leadership for the Digital Age

Anne Williamson

Victor and Caroline Schutte/Missouri Professor of Urban Affairs, University of Missouri—Kansas City

MPA Internships: Preparing Pre-Service MPA Students for the New Public Service

3:45 p.m. - 5:00 p.m.

New Jersey

Public Branding in a Globalized World

Global Public Administration

Endorsed By:

International Chapter and Section for Women in Public Administration

MODERATOR

Jasper Eshuis

Associate Professor, Erasmus University

DISCUSSANT

Staci Zavattaro

Associate Professor, University of Central Florida

PRESENTERS

Vincent Mabillard

Doctoral Student and Research Fellow, University of Lausanne

Place Branding and Openness: What Kind of Transparency Matters for Economic Attractiveness?

Kevin Mason

Student, Carleton University

The Brand Factor: Political Branding and the Policy Process

Wawrzyniec Rudolf

Assistant Professor, University of Lodz

Communication of Brand Personality by European Cities: An International Study of Municipal Activities in Social Media

Serena Wider

Doctoral Student, Copenhagen Business School

How Do Images Become? A Performativity Lens on the Processes of Place Brand

PRESENTERS/COAUTHORS

Kyle Murray

Professor, University of Alberta

“Pushing Pot”: Public-Sector Branding of Cannabis in Canada

Renaud Vuignier

Research Fellow, University of Lausanne

Place Branding and Openness: What Kind of Transparency Matters for Economic Attractiveness?

Jared Wesley

Associate Professor, University of Alberta

“Pushing Pot”: Public-Sector Branding of Cannabis in Canada

Panels *(continued)*

3:45 p.m. - 5:00 p.m.

Virginia

Neptism: The Collapse of Public Administration and Democracy

Global Public Administration

Endorsed By:

Section on Democracy and Social Justice and Section on Public Law and Administration

MODERATOR

Dovie Dawson

Lecturer, Social and Behavioral Sciences Department, Central Texas College

PRESENTERS

Sharon Bowen

Former Commissioner, Commodity Futures Trading Commission and Partner, Seneca Women

Raymond Cox

Professor Emeritus, University of Akron

Thomas Martin

Partner, Goldblatt, Martin, Pozen LLP

Kenyan McDuffie

Chairman Pro Tempore and Councilmember, Council of the District of Columbia

3:45 p.m. - 5:00 p.m.

North Carolina

Sustaining a Fiscally Sound Public Sector Amid Challenges, Changes and Uncertainties

Public Finance

Endorsed By:

Association for Budgeting and Financial Management and Section for Women in Public Administration

MODERATOR/PRESENTER

Helisse Levine

Professor and MPA Director, Long Island University—Brooklyn

Keep the Lights Burning, Muni? An Examination of Changing Financial Conditions in Small Municipalities Since 2000

DISCUSSANT/PRESENTER

Marc Fudge

Associate Professor, California State University—San Bernardino

Land Value Capture in the United States: A Strategy for Adoption and Implementation

PRESENTERS

Minhee Kim

Doctoral Student, University of Delaware

Horizontal Local Revenue Sharing in Seoul, Korea

Eddie Summers

Assistant Professor, Long Island University—Brooklyn

Re-Examining the Role of New York State Industrial Development Agencies in Local Economic Development

3:45 p.m. - 5:00 p.m.

Massachusetts

Tricks or Treats: The Impact of Incentives on Fiscal Health

Public Finance

Endorsed By:

Association for Budgeting and Financial Management

MODERATOR/PRESENTER

Bruce McDonald

Associate Professor, North Carolina State University

You Don't Always Get What You Want: The Effect of Financial Incentives on State Fiscal Health

PRESENTERS/COAUTHORS

David Copeland

Doctoral Student, Georgia State University

Returns to Later-Age Degrees

Michael Overton

Assistant Professor, University of Idaho

Property Tax Volatility and Local Economic Development: An Empirical Test of Fiscal Health Using Texas Counties

Jingran Sun

Doctoral Student, University of North Texas

The Effects of Property Tax Exemptions on Municipalities' Service Delivery

COAUTHORS

Robert Bland

Endowed Professor of Local Government, University of North Texas

The Effects of Property Tax Exemptions on Municipalities' Service Delivery

Panels *(continued)*

John Decker

Student, North Carolina State University
You Don't Always Get What You Want: The Effect of Financial Incentives on State Fiscal Health

Alex Hathaway

Research Associate II, Georgia State University
Returns to Later-Age Degrees

Brad Johnson

Doctoral Student, North Carolina State University
You Don't Always Get What You Want: The Effect of Financial Incentives on State Fiscal Health

Tom Mroz

Professor and Chair, Georgia State University
Returns to Later-Age Degrees

Lakshmi Pandey

Senior Research Associate, Georgia State University
Returns to Later-Age Degrees

Eric Stokan

Assistant Professor, University of Maryland—Baltimore County
Property Tax Volatility and Local Economic Development: An Empirical Test of Fiscal Health Using Texas Counties

Sally Wallace

Professor and Dean, Georgia State University
Returns to Later-Age Degrees

3:45 p.m. - 5:00 p.m.

New York

The Role of Procurement in Governance: Managing Relationships to Serve the Public Interest

Public Finance

Endorsed By:

Association for Budgeting and Financial Management, Section for Women in Public Administration, Section on Complexity and Network Studies and Section on Procurement and Contract Management

MODERATOR

Trevor Brown

Dean and Professor, Ohio State University

PRESENTER

Ying Jiang

Postdoctorate, Arizona State University and Dalian University of Technology
The Influential Factors of the Dual-Governance Mechanism of Contractual and Relational Governance of Public-Private Partnership Infrastructure Projects in China

PRESENTERS/COAUTHORS

Sawsan Abutabenjeh

Assistant Professor, Mississippi State University
State Procurement and Contract Management Deficiencies

Rene Rendon

Associate Professor, U.S. Naval Postgraduate School
A Comparative Analysis: Federal and Local Government Contract Prices

Joshua Steinfeld

Assistant Professor, Old Dominion University
Negotiating the Terms: A Grounded Theory Study of Procurement in Public and Private Organizations

Min Xiong

Doctoral Student, Florida International University
Public-Private Partnerships in China in the New Era: A Social Network Analysis

COAUTHORS

Latika Hartmann

Associate Professor, Naval Postgraduate School
A Comparative Analysis: Federal and Local Government Contract Prices

Dolores Kuchina-Musina

Doctoral Student, Old Dominion University
Negotiating the Terms: A Grounded Theory Study of Procurement in Public and Private Organizations

Karen Landale

Lt. Colonel, U.S. Air Force, Naval Postgraduate School
A Comparative Analysis: Federal and Local Government Contract Prices

John Morris

Professor, Old Dominion University
Negotiating the Terms: A Grounded Theory Study of Procurement in Public and Private Organizations

Panels *(continued)*

Rene Rendon

Associate Professor, U.S. Naval Postgraduate School
State Procurement and Contract Management Deficiencies

Travis Whetsell

Assistant Professor, Florida International University
Public-Private Partnerships in China in the New Era: A Social Network Analysis

Zhirong Zhao

Associate Professor, University of Minnesota
Public-Private Partnerships in China in the New Era: A Social Network Analysis

Founders' Fellows Orientation and Welcome Reception

6:30 p.m. - 7:30 p.m.

Senate

THE UNIVERSITY OF NORTH CAROLINA *at* CHAPEL HILL

3rd IN CITY MANAGEMENT
by *US News & World Report*
"Best Graduate School Rankings"

2 WAYS TO EARN AN MPA:
On campus and Online (MPA@UNC)

20 FACULTY INFLUENCING THE FUTURE OF
PUBLIC ADMINISTRATION:

Whitney Afonso
Gregory S. Allison
David N. Ammons
Maureen Berner
Leisha DeHart-Davis

Margaret Henderson
Michele Hoyman
Jeffrey A. Hughes
Willow Jacobson
Kara A. Millonzi

Jonathan Q. Morgan
Ricardo S. Morse
C. Tyler Mulligan
Kimberly L. Nelson
William C. Rivenbark

Dale J. Roenigk
Carl W. Stenberg
John B. Stephens
Charles Szypszak
Shannon Tufts



SCHOOL OF GOVERNMENT
Master of Public Administration

mpa.unc.edu

We lead the way in developing new models of governance by redefining ideas about public management and policy both in the classroom and in public institutions.

Leading academic programs

#1 university for
innovation
US News & World Report, 2018

School of Public Affairs

- #2** Local Government Management
- #3** Homeland Security and Emergency Management
- #4** Information Technology
- #7** Public Management and Leadership
- #10** Public Finance
- #9** Overall

— US News & World Report, 2018

Recruiting MPA students

Marvin Andrews Fellowships in Urban Management

Two-year program starts each fall
(applications due March 15)

- Full tuition waivers
- Paid internships

spa.asu.edu/andrews

Distinguished faculty

New Editorship Positions

Mary Feeney, Editor
Journal of Public Administration & Theory

Chris Herbst, Co-Editor - Social Policy
Journal of Policy Analysis & Management

Yushim Kim, Co-Editor - Environmental Policy
Journal of Policy Analysis & Management

Recent PhD graduate job placements

Federica Fusi, PhD
Assistant Professor
University of Illinois at Chicago
Department of Public Administration



TRACKS

Global Public Administration

Infrastructure

Public Finance

Public Service

Social Equity

SATURDAY SESSIONS

#ASPA2019

Commit to Excellence



Congratulations to
PhD Alum
Mary K. Feeney

Editor: *Journal of Public
Administration Research
& Theory*



Congratulations to
Katherine Willoughby
on her new book

*Public Performance
Budgeting: Principles
and Practice*



Congratulations to
Eric Zeemering
New MPA Director



UNIVERSITY OF GEORGIA

Saturday Sessions MARCH 9

TRACKS: ● Public Finance ● Infrastructure ● Social Equity ● Public Service ● Global PA

SESSION	TIME	Room
ASPA Registration Open	7:00 a.m. – 6:00 p.m.	Promenade Foyer
<i>American Review of Public Administration (ARPA)</i> Journal Editors Meeting	7:30 a.m. – 8:45 a.m.	Maryland
Center for Accountability and Performance Business Meeting and Emerging Leaders Presentations	7:30 a.m. – 8:45 a.m.	South Carolina
International Chapter Meeting	7:30 a.m. – 8:45 a.m.	Massachusetts
<i>International Journal of Public Administration (IJPA)</i> Editors Meeting	7:30 a.m. – 8:45 a.m.	Rhode Island
NECOPA and New York Metropolitan Chapter Meeting	7:30 a.m. – 8:45 a.m.	Pennsylvania
SCPA Meeting	7:30 a.m. – 8:45 a.m.	Virginia
SCNS Meeting	7:30 a.m. – 8:45 a.m.	New Hampshire
SICA Meeting	7:30 a.m. – 8:45 a.m.	New York
SPAR Meeting	7:30 a.m. – 8:45 a.m.	North Carolina
SNAPS Meeting	7:30 a.m. – 8:45 a.m.	New Jersey
Opening Plenary	9:00 a.m. – 10:30 a.m.	Grand Ballroom
● Presidential Panel—Looking Ahead: What the Public Sector of the Future Must Look Like (<i>Public Service Focus</i>)	10:45 a.m. – 12:00 p.m.	Chinese Ballroom
Founders' Fellows Panel: Citizen Participation and the Creation of Public Value	10:45 a.m. – 12:00 p.m.	Virginia
● Refugees, Immigrants and Public Policy in East Asia: A Two-Nation Collaboration	10:45 a.m. – 12:00 p.m.	New Jersey
● Developments in Countries Navigating Governance Transition	10:45 a.m. – 12:00 p.m.	Maryland
● KIPA Session—Promoting Innovative and Inclusive Government: Korea Experiences	10:45 a.m. – 12:00 p.m.	Rhode Island
● Politics, Economics and Governance in China	10:45 a.m. – 12:00 p.m.	New York
● Truth and Integrity in State Budgeting: Critical Issues in Fiscal Policy, Debt Management and Financial Reporting	10:45 a.m. – 12:00 p.m.	Pennsylvania
● Finance in the States: Local Governments' Efforts and Performance	10:45 a.m. – 12:00 p.m.	South Carolina
● Public Service Tenets: Past to Present	10:45 a.m. – 12:00 p.m.	Senate
● Complex Governance Systems: Theories and Applications	10:45 a.m. – 12:00 p.m.	Independence
● Diversity and Representation	10:45 a.m. – 12:00 p.m.	New Hampshire
● Efforts and Impacts of Community Organizations, Nonprofits and Local Government Service Delivery	10:45 a.m. – 12:00 p.m.	Massachusetts
● Institutions and Social Equity Considerations	10:45 a.m. – 12:00 p.m.	Suite 230
● Marc Holzer Public Performance Symposium	10:45 a.m. – 3:00 p.m.	North Carolina
● Presidential Panel—Public Administration Advancing Rule of Law in Post-Conflict Nations (<i>Global Public Administration Focus</i>)	12:15 p.m. – 1:30 p.m.	Chinese Ballroom
Chapter Leadership Meeting	12:15 p.m. – 1:30 p.m.	Independence
● Non-Democratic Governance: Can Collaboration and Participation Help?	12:15 p.m. – 1:30 p.m.	New Jersey
● The Accra Model for Addressing Complex Challenges: Cross-Sector Collaboration for Health Policy Transformation in Urban Slums	12:15 p.m. – 1:30 p.m.	Suite 230
● Have Anti-Corruption Measures Failed? Why?	12:15 p.m. – 1:30 p.m.	Rhode Island
● Collaborative Health Governance	12:15 p.m. – 1:30 p.m.	Maryland
● Enabling Success for All Students: Examining School Finance and Funding with an Equity Lens through All Levels of Government	12:15 p.m. – 1:30 p.m.	Pennsylvania

MARCH 9 Saturday Sessions

TRACKS: ● Public Finance ● Infrastructure ● Social Equity ● Public Service ● Global PA

SESSION	TIME	Room
● Fiscal Issues in Public Administration	12:15 p.m. - 1:30 p.m.	New York
● Government Finances through Future Cycles	12:15 p.m. - 1:30 p.m.	Massachusetts
● The Latest on Leadership	12:15 p.m. - 1:30 p.m.	Virginia
● Collaboration in Public Service	12:15 p.m. - 1:30 p.m.	New Hampshire
● Ethics in Action	12:15 p.m. - 1:30 p.m.	South Carolina
Past Presidents' Luncheon <i>(By Invitation)</i>	12:15 p.m. - 2:00 p.m.	District Ballroom
Exhibit Hall Open	12:30 p.m. - 6:30 p.m.	State and East Rooms
● Presidential Panel—The New Financial Sustainability Network <i>(Public Finance Focus)</i>	1:45 p.m. - 3:00 p.m.	Chinese Ballroom
Section Leadership Meeting	3:15 p.m. - 4:30 p.m.	Independence
● Big Questions for Public Administration in the Age of Conviction Politics, Presidential Populism and Neo-Globalization	3:15 p.m. - 4:30 p.m.	New Hampshire
● Network Governance in China and the United States	3:15 p.m. - 4:30 p.m.	New Jersey
● Governance Challenges in Public Service: Structural, Behavior and Performance Studies in East Asia	3:15 p.m. - 4:30 p.m.	Virginia
● Toward Good Governance in China	3:15 p.m. - 4:30 p.m.	Maryland
● Impacts of Government Management Form, Capacity and Quality	3:15 p.m. - 4:30 p.m.	Pennsylvania
● Accountability at the Center of Public Finance and Public Service	3:15 p.m. - 4:30 p.m.	Rhode Island
● Education and Nonprofit Financing Issues	3:15 p.m. - 4:30 p.m.	New York
● NAPA Session—Grand Challenges in Public Administration in the 2020s: The View from Multiple Sectors	3:15 p.m. - 4:30 p.m.	Massachusetts
● <i>Public Integrity</i> 20th Anniversary Symposium	3:15 p.m. - 4:30 p.m.	Senate
● What Will Government Look Like in 2040?	3:15 p.m. - 4:30 p.m.	South Carolina
● Students and New Administration Professionals Section Job Market Show Case	3:15 p.m. - 4:30 p.m.	North Carolina
● Social Equity, Diversity and Inclusion Workshop	4:00 p.m. - 7:00 p.m.	Chinese Ballroom
NAPA Fellows Meeting	4:45 p.m. - 6:00 p.m.	Massachusetts
● The Role of Local Governments in United States and European Regional Governance	4:45 p.m. - 6:00 p.m.	New Hampshire
● The Globalization and Politicization of Migration: Balancing Domestic and International Challenges	4:45 p.m. - 6:00 p.m.	South Carolina
● Public Finance in an Uncertain Environment in Asia	4:45 p.m. - 6:00 p.m.	Rhode Island
● Fiscal Health: From Sustainability and Stabilization to Pension and Debt	4:45 p.m. - 6:00 p.m.	New Jersey
● NASPAA Site Visitor Training	4:45 p.m. - 6:00 p.m.	Independence
● Entrepreneurial Governance	4:45 p.m. - 6:00 p.m.	Pennsylvania
● Performance Management Issues in Public Administration	4:45 p.m. - 6:00 p.m.	North Carolina
● The Value of Public Service	4:45 p.m. - 6:00 p.m.	Maryland
● Celebrating Minnowbrook at 50: Social Equity Past, Present and Future	4:45 p.m. - 6:00 p.m.	Senate
● Astana Civil Service Hub (ACSH) Session—Modern Trends and Challenges of Public Service in Post-Soviet and Transition Countries	4:45 p.m. - 6:45 p.m.	New York
Welcome Reception	6:30 p.m. - 8:30 p.m.	Grand Ballroom, Mayflower Hotel

TRACKS: ● Public Finance ● Infrastructure ● Social Equity ● Public Service ● Global

Opening Plenary

9:00 a.m. - 10:30 a.m. Grand Ballroom

LECTURER

Anthony Williams

Chief Executive Officer and Executive Director, Federal City Council

SPEAKERS

Paul Danczyk

Director, Executive Education in Sacramento, University of Southern California and ASPA Incoming President

Jane Pisano

Professor, Price School of Public Policy, University of Southern California

MASTER OF CEREMONIES

J. Paul Blake

District IV Representative, ASPA National Council

Presidential Panel

10:45 a.m. - 12:00 p.m. Chinese Ballroom

Looking Ahead: What the Public Sector of the Future Must Look Like

Public Service

PRESENTERS

Shawn Skelly

Commissioner, National Commission on Military, National and Public Service

Bill Valdez

President, Senior Executives Association

Heidi Voorhees

President and Co-Owner, GovHR USA

Founders' Fellows Panel

10:45 a.m. - 12:00 p.m. Virginia

Citizen Participation and the Creation of Public Value

MODERATOR/PRESENTER

Jennifer Swann

Administrative Coordinator, The City of Oklahoma City Planning Department

Moving the Needle Forward in the Right-to-Food Discourse: Consumer Empowerment as the Realization of Substantive Justice

PRESENTERS

Michael Bednarczuk

Adjunct Instructor of Political Science, Ohio University—Chillicothe

Public Service Motivation in the Military: A Long-Term Panel Study of the Vietnam War

Donwe Choi

Doctoral Student, Florida State University
Social Enterprise and Public Value Creation

Amelia Pridemore

Doctoral Student, Florida International University
Kindred Spirits and Unlikely Allies: Breaking Barriers to Music and Arts Communities through Citizen Participation in Local Government

Jie Tao

Doctoral Student, University of North Texas
Do Traditional Citizen Participation and E-Participation Make a Difference in Terms of Their Effects on Citizen Satisfaction? Evidence from Local U.S. Governments

Panels

10:45 a.m. - 12:00 p.m. New Jersey

Refugees, Immigrants and Public Policy in East Asia: A Two-Nation Collaboration

Global Public Administration

Endorsed By:

International Chapter, Section on Democracy and Social Justice and Section on Health and Human Services Administration

MODERATOR/DISCUSSANT

J. Steven Ott

Professor and Dean Emeritus, University of Utah

Panels *(continued)*

PRESENTERS

Minhyuk Cho

Doctoral Student, SungKyunKwan University
The Role of Nongovernmental Organizations in Refugee and Immigrant Integration

Minjung Kim

Doctoral Student, SungKyunKwan University
Mapping Policy Networks and Discourse on Refugees and Immigrants

Lina Svedin

Associate Professor, Director of Public Affairs Programs, University of Utah
South Korean Perceptions and Framing of Migrants as Target Populations

PRESENTER/COAUTHOR

Hwayeon Kim

Doctoral Student, SungKyunKwan University
South Korean Perceptions and Framing of Migrants as Target Populations

COAUTHOR

Mingil Kim

Doctoral Student, SungKyunKwan University
Health Care Needs in Immigrant Populations: South Korean Perceptions and Framing of Migrants as Target Populations

10:45 a.m. - 12:00 p.m.

Maryland

Developments in Countries Navigating Governance Transition

Global Public Administration

MODERATOR/PRESENTER

David Bell

Assistant Professor, Savannah State University
International Collaboration of Public Administration Organizations: Foreign Aid Donors, Central Bank and Credible Policy

PRESENTERS

Celso De Souza

FGV
Vertical Power Relations in Contemporary Brazil

Kristina Hoghova

Doctoral Student, University of Ss. Cyril and Methodius in Trnava
The Specific Status of Catalonia in the Territorial Self-Government of Spain: The "Problem" of National Identity

Daniel Kenealy

Lecturer and Assistant Professor, University of Edinburgh
Whitehall Traditions and Constitutional Dilemmas: (Re)-Interpreting Intergovernmental Relations in the United Kingdom

Cristina Rodriguez-Acosta

Assistant Director, Florida International University
Decentralization, Local Government and Democratic Political and Economic Development in Latin America: An Overview and Assessment

10:45 a.m. - 12:00 p.m.

Rhode Island

KIPA Session—Promoting Innovative and Inclusive Government: Korea Experiences

Global Public Administration

Endorsed By:

Section on Public Administration Research

MODERATOR

Jae Ho Eun

Vice President, Korea Institute of Public Administration

DISCUSSANT

Dongjae Jung

Associate Research Fellow, Korea Institute of Public Administration

PRESENTERS

Yun Kwon Kim

Senior Research Fellow, Korea Institute of Public Administration
Collaboration across Public Administration Organizations

DoSuk Lee

Research Fellow, Korea Institute of Public Administration
Why Does Ethical Leadership Matter for Innovation, Social Participation and Individual Motivation? A Focus on the Comparison Between Public and Private Organizations

Panels *(continued)*

Minho Lee

Senior Research Fellow, Korea Institute of Public Administration
Effects of Deregulatory Policy on Economic Performance in Korea: Empirical Analysis Using the Industrial Deregulation Index

Hyeon Suk Lyu

Senior Research Fellow, Korea Institute of Public Administration
Disaster Officials' Commitment, Satisfaction and Work-Related Stress Among Coastal Guards, Firefighters and Administrative Officials in Korea after the Sinking of the Sewol Ferry

Kun Yoon

Associate Research Fellow, Korea Institute of Public Administration
Developing the Citizen Participation Capacity Index

10:45 a.m. - 12:00 p.m.

New York

Politics, Economics and Governance in China

Public Finance

Endorsed By:

International Chapter and Section on Chinese Public Administration

PRESENTERS

Qian Li

Assistant Professor, China University of Political Science and Law
How Does Performance Measurement Trigger Red Tape in Local Government? Lessons from the Targeted Poverty Alleviation Plan in China

Junli Yu

Assistant Professor, Shanghai Jiaotong University
Public Goods Supply Equilibrium and Community Governance

PRESENTERS/COAUTHORS

Zhao Qi

Doctoral Student, Peking University
Network Position and Policy Entrepreneur's Influence Based on the Study of Wenlin's Democratic Discussion

Hongtao Shen

Associate Professor, Lingnan Normal University
Pharmaceutical Pricing and Reimbursement Policies in China: Practice and Challenges

Yi Zhang

Associate Professor, University of International Business and Economics
Political Connection and Nonprofit Financial Resource: How Does Indirect Government Involvement Work in China?

COAUTHORS

Tobin Im

Professor, Seoul National University
Political Connection and Nonprofit Financial Resource: How Does Indirect Government Involvement Work in China?

Xuefeng Liang

Professor, Harbin Institute of Technology
Pharmaceutical Pricing and Reimbursement Policies in China: Practice and Challenges

Ying Zhang

Nurse, Lingnan Normal University
Pharmaceutical Pricing and Reimbursement Policies in China: Practice and Challenges

10:45 a.m. - 12:00 p.m.

Pennsylvania

Truth and Integrity in State Budgeting: Critical Issues in Fiscal Policy, Debt Management and Financial Reporting

Public Finance

Endorsed By:

Association for Budgeting and Financial Management, Section on Democracy and Social Justice and Section on Intergovernmental Administration and Management

MODERATOR/PRESENTER

W. Bartley Hildreth

Professor, Georgia State University
Challenges and Benefits of the Truth and Integrity in State Budgeting

PRESENTERS

Merl Hackbart

Professor, University of Kentucky
Challenges and Benefits of the Truth and Integrity in State Budgeting
 and
State Debt Liabilities: Oversight and Management

Alex Hathaway

Research Associate II, Georgia State University
Fiscal Transparency and Legacy Costs

Panels *(continued)*

PRESENTERS/COAUTHORS

Daniel Castro

MPA Student, Florida International University
Disclosure of Tax Expenditure in State Budgeting and Rainy Day Fund and Revenue Volatility

David Hai Guo

Associate Professor, Florida International University
Rainy Day Fund and Revenue Volatility and Disclosure of Tax Expenditure in State Budgeting

COAUTHORS

Howard Frank

Chair, Department of Public Administration, Florida International University
Rainy Day Fund and Revenue Volatility

Rhonda Trautman

Director, Public Financial Management, University of Kentucky
State Debt Liabilities: Oversight and Management

10:45 a.m. - 12:00 p.m. South Carolina

Finance in the States: Local Governments' Efforts and Performance

Public Finance

Endorsed By:

Section on Intergovernmental Administration and Management and Section on Public Performance and Management

PRESENTERS

NakHyeok Choi

Research Fellow, Audit and Inspection Research Institute of Korea
Local Government Capacity and Performance: Expenditure, Performance and Competition

Cary Christian

Associate Professor, Georgia Southern University
Weathering the Great Recession: Evidence from Small to Medium Cities across 18 States

Sungkyu Jang

Assistant Professor, Indiana University—South Bend
The Effects of County Delinquent Tax Collection Outsourcing on Tax Collection Performances

PRESENTER/COAUTHOR

Per Johnson

MPA Student, Georgia State University
Local Government Tax Expenditures in an Environment of Overlapping Jurisdictions

COAUTHOR

Laura Wheeler

Senior Research Associate, Georgia State University
Local Government Tax Expenditures in an Environment of Overlapping Jurisdictions

10:45 a.m. - 12:00 p.m.

Senate

Public Service Tenets: Past to Present

Public Service

Endorsed By:

Section for Women in Public Administration, Section on Public Administration Research and Section on Public Law and Administration

MODERATOR/PRESENTER

Eric Click

ASPAs Secretariat to IPAC, MPA Area Coordinator for Global Governance and Associate Professor and BPA Program Director, Park University
Why Public Service? Market Failure

PRESENTERS

Suzanne Discenza

ASPAs National Council District IV Representative, Professor (Retired), Consultant and Lecturer, University of Colorado Denver and University of Colorado Colorado Springs
The Persistence of Conflicting Viewpoints on Health Care as a Fundamental Public Good

Melissa Emerson

Assistant Professor, University of Wisconsin—Stout
Civil Legal Aid: Using the Private Sector to Serve the Public Interest

Rebekkah Stuteville

Assistant Dean for Academic Support Services and Teaching Associate Professor, Kansas State University—Olathe
Reflections on HUD's Scandals and Public Service Values: A View from the Bottom

Panels *(continued)*

Anne Swafford

Adjunct Professor, Park University
The Impact of the Differing Political Cultures of the Four British Migrations on the Founding of Our Democratic Republic and Public Administration Today

10:45 a.m. - 12:00 p.m. Independence

Complex Governance Systems: Theories and Applications

Public Service

Endorsed By:
 Section on Complexity and Network Studies, Section on Intergovernmental Administration and Management and Section on Public Administration Research

MODERATOR/COAUTHOR

Bing Ran

Associate Professor, Penn State Harrisburg
A Complex Adaptive System: Collective Action, Online Participation, Social Identity and Political Efficacy

PRESENTER

Goktug Morcol

Professor, Penn State University
Public Service in Complex Governance Systems: A Proposal for Reconceptualization

PRESENTERS/COAUTHORS

Shahinshah Azim

Doctoral Student, Penn State Harrisburg
The Collaborative Governance Networks Literature: A Thematic Analysis

JooHo Lee

Associate Professor, University of Nebraska—Omaha
The Role of Interagency Collaboration and Incentives in Translating a Climate of Creativity to Innovation in Local Government

Pamela Mischen

Associate Professor, Binghamton University, The State University of New York
Creating Sustainable Systems: Resilient and Adaptive Networks

Saahir Shafi

Doctoral Student, Penn State Harrisburg
A Complex Adaptive System: Collective Action, Online Participation, Social Identity and Political Efficacy

COAUTHORS

Ximeng Chen

Doctoral Student, Binghamton University, The State University of New York
Creating Sustainable Systems: Resilient and Adaptive Networks

Soonhee Kim

Professor, KDI School of Public Policy and Management
The Role of Interagency Collaboration and Incentives in Translating a Climate of Creativity to Innovation in Local Government

Carl Lipo

Professor, Binghamton University, The State University of New York
Creating Sustainable Systems: Resilient and Adaptive Networks

Goktug Morcol

Professor, Penn State University
The Collaborative Governance Networks Literature: A Thematic Analysis

Hiroki Sayama

Doctoral Student, Binghamton University, The State University of New York
Creating Sustainable Systems: Resilient and Adaptive Networks

Eunsil Yoo

Doctoral Student, Penn State Harrisburg
The Collaborative Governance Networks Literature: A Thematic Analysis

10:45 a.m. - 12:00 p.m. New Hampshire

Diversity and Representation

Public Service

Endorsed By:
 Section for Women in Public Administration, Section on Democracy and Social Justice and Students and New Administration Professionals Section

PRESENTERS

Sara Reed

MPA Director and Assistant Professor, Upper Iowa University
The Influence of Category Rating on Diversity in the Federal Government Workforce

Panels *(continued)*

Gary Roberts

Professor, Regent University
Servant Leader Human Resource Management

PRESENTERS/COAUTHORS

Candice Bodkin

Assistant Professor, Georgia Southern University
Ascending to Managerhood: An Examination of the Career Paths of Local Government Executives

Casey Fleming

Assistant Professor, East Carolina University
Ascending to Managerhood: An Examination of the Career Paths of Local Government Executives

Ishtiaq Jamil

Associate Professor, University of Bergen
Representative Bureaucracy and Affirmative Policy: Bangladesh and Nepal Compared

Syeda Lasna Kabir

Professor, University of Dhaka and North South University
Representative Bureaucracy and Affirmative Policy: Bangladesh and Nepal Compared

Kathryn Webb Farley

Assistant Professor, Appalachian State University
Gendered Representation and Socialization: The Case of City Managers

COAUTHORS

Robert Eskridge

Associate Professor, Appalachian State University
Gendered Representation and Socialization: The Case of City Managers

Beth Rauhaus

Assistant Professor and MPA Graduate Coordinator, Texas A&M University—Corpus Christi
Gendered Representation and Socialization: The Case of City Managers

10:45 a.m. - 12:00 p.m.

Massachusetts

Efforts and Impacts of Community Organizations, Nonprofits and Local Government Service Delivery

Public Service

Endorsed By:

Section on Democracy and Social Justice, Section on Ethics and Integrity in Governance, Section on Health and Human Services Administration and Section on Public Administration Research

PRESENTER

Paul Goodfellow

Environmental Program Manager III, Alaska Department of Environmental Conservation
A Rural Alaskan Emissions Inventory: Analyzing the Pedro Bay Emissions Inventory

PRESENTERS/COAUTHORS

Hugo Asencio

Assistant Professor, California State University—Dominguez Hills
Nonprofit Organizations: Effective Relationships for First Responders

Theodore Byrne

Associate Professor, California State University—Dominguez Hills
Nonprofit Organizations: Effective Relationships for First Responders

Meeyoung Lamothe

Associate Professor, University of Oklahoma
An In-Depth Look at the Role of Nonprofits in Local Public Service Delivery

Edin Mujkic

Assistant Professor, University of Colorado Colorado Springs
Nonprofit Organizations: Effective Relationships for First Responders

Jiwon Nam

Assistant Professor, University of Baltimore
Discovering Co-Production of Wind Power Farms as a Common Pool Resource: The Serendipitous Case of Jeju Island, South Korea

Panels *(continued)*

COAUTHORS

Frances Berry

Reubin O.D. Askew Eminent Scholar and Frank Sherwood Professor of Public Administration, Florida State University

Discovering Co-Production of Wind Power Farms as a Common Pool Resource: The Serendipitous Case of Jeju Island, South Korea

Donwe Choi

Doctoral Student, Florida State University

Discovering Co-Production of Wind Power Farms as a Common Pool Resource: The Serendipitous Case of Jeju Island, South Korea

10:45 a.m. - 12:00 p.m.

Suite 230

Institutions and Social Equity Considerations

Social Equity

PRESENTERS

Michael Ford

Assistant Professor, University of Wisconsin—Oshkosh
School Sector Mobility in a Mature School Choice Environment

Huafang Li

Assistant Professor, Grand Valley State University
Representative Bureaucracy and the Importance of Order Effects

Gopal Sanghaik

Associate Professor, Rajiv Gandhi Government Degree College
Policy Initiatives for Equitable Access to Higher Education in India: Challenges and a Way Forward

Marc Holzer Public Performance Symposium

10:45 a.m. - 3:00 p.m.

North Carolina

The following data was provided by the Section.

10:45 a.m. - 12:10 p.m.

Understanding and Promoting the Use of Performance Measures in Government

PRESENTERS

Yoonho Kim

Professor, University of Seoul

Does the Implementation of GPRAMA Result in the Development of Performance Measures?

Kaifeng Yang

Dean and Professor, School of Public Administration and Policy, Renmin University of China

Proactive Results Transparency When There is Underperformance: Drivers and Barriers

PRESENTERS/COAUTHORS

Richard Beck

Retired Federal Executive

Observations on Applying Performance and Funding Trend Data to Foster Dialogue and Increase Use of Performance Data

Yuan (Daniel) Cheng

Assistant Professor, University of Minnesota

Does Charitable Support Lead to Better Public Service Performance? Evidence from U.S. State Park Systems

Beth Gazley

Professor, Indiana University

Does Charitable Support Lead to Better Public Service Performance? Evidence from U.S. State Park Systems

Chantelle Lafontant

Doctoral Student, Indiana University

Does Charitable Support Lead to Better Public Service Performance? Evidence from U.S. State Park Systems

John O'Brien

Associate Professor, National Defense University

Observations on Applying Performance and Funding Trend Data to Foster Dialogue and Increase Use of Performance Data

Marc Holzer Public Performance Symposium *(continued)*

12:20 p.m. - 1:25 p.m.

Luncheon Honoring Marc Holzer and Announcement of Best Symposium Paper and Best PPMR Article Awards

1:35 p.m. - 3:00 p.m.

Applying Performance Measures to Public Policy Issues

PRESENTER

Xu Han

Doctoral Student, University of Maryland
The Impact of Performance Management on Civic Participation at U.S. High Schools

PRESENTERS/COAUTHORS

Hyun Joon Kim

Professor, Korea University
Are Satisfied Citizens Willing to Participate More? An Analysis of Citizens' Satisfaction and Public Participation Survey

Na Yeon Kim

Research Fellow, Seoul National University
Are Satisfied Citizens Willing to Participate More? An Analysis of Citizens' Satisfaction and Public Participation Survey

Sun Hee Kim

Research Associate, Korea University
Are Satisfied Citizens Willing to Participate More? An Analysis of Citizens' Satisfaction and Public Participation Survey

Jiagi Liang

Assistant Professor, University of Illinois—Chicago
Economic Dominance, Goal Dynamics of Local Governments and Organizational Environmental Performance

Elaine Yi Lu

Professor, John Jay College, City University of New York
Examining the Longer Term Impact of Performance Budgeting: A Longitudinal Analysis of Juvenile Justice Services in United States

Liang Ma

Associate Professor, Renmin University
Economic Dominance, Goal Dynamics of Local Governments and Organizational Environmental Performance

Katherine Willoughby

Professor, University of Georgia
Examining the Longer Term Impact of Performance Budgeting: A Longitudinal Analysis of Juvenile Justice Services in United States

Presidential Panel

12:15 p.m. - 1:30 p.m.

Chinese Ballroom

Public Administration Advancing Rule of Law in Post-Conflict Nations

Global Public Administration

MODERATOR

Rich Callahan

Editor, *International Journal of Public Leadership* and Professor, University of San Francisco

PRESENTERS

Stéphane Jean

Judicial Officer, Office of Rule of Law and Security Institutions, Department of Peace Operations, United Nations

Mark Kroecker

Senior Partner, Kroecker Partners LLC

Fron Nahzi

Senior Director of Global Development, McCain Institute for International Leadership, Arizona State University

Chapter Leadership Meeting

12:15 p.m. - 1:30 p.m.

Independence

PRESENTERS

Pilar Gorordo

Retired

Stephen Rolandi

Adjunct Professor of Public Administration, Pace University and John Jay College of Criminal Justice, City University of New York

Panels

12:15 p.m. - 1:30 p.m.

New Jersey

Non-Democratic Governance: Can Collaboration and Participation Help?

Global Public Administration

Endorsed By:

Association for Budgeting and Financial Management, Section on Chinese Public Administration, Section on Complexity and Network Studies and Section on Democracy and Social Justice

MODERATOR/PRESENTER

Bing Ran

Associate Professor, Penn State Harrisburg
Is It an Odd Couple? Making Sense of the Curious Combination of Collaborative Governance and Non-Democratic Societies

DISCUSSANT

Marc Holzer

Distinguished Professor, Suffolk University

PRESENTERS/COAUTHORS

Ning Jing

Ocean University of China
How Government Procurement Policy Plays Its Functions in China: An Empirical Analysis Based on Political Documents from 2002 to 2017

Weiwei Song

Associate Professor, Central University of Finance and Economics
Research on the Path of Chinese Government Data Governance Capability Enhancement under the Background of Data Opening

Zhe Xiao

Doctoral Student and Visiting Scholar, University of Kansas, Nanjing University
What We Get and How: Evidence from 102 Cases of Public Participation in China

COAUTHOR

Shu Wei

Professor, Nanjing University
What We Get and How: Evidence from 102 Cases of Public Participation in China

12:15 p.m. - 1:30 p.m.

Suite 230

The Accra Model for Addressing Complex Challenges: Cross-Sector Collaboration for Health Policy Transformation in Urban Slums

Global Public Administration

Endorsed By:

Section on Complexity and Network Studies, Section on Health and Human Services Administration and Section on Public Administration Research

MODERATOR/PRESENTER

Jessica Kritz

Assistant Research Professor, Georgetown University
Creating the Accra Model for Addressing Complex Challenges

DISCUSSANT

Joseph Darmoe

Director of Research, Statistics and Information Management, Ministry of Inner-City and Zongo Development, Republic of Ghana

PRESENTERS

Peter Batsa

Facilitator and Project Manager, Ghana National Catholic Health Service
Facilitating Cross-Sector Collaboration around an Urban Slum

Simpson Boateng

Former Accra Metropolitan Assembly Director of Public Health, Ministry of Health, Republic of Ghana
The Complex Challenge of Old Fadama in 2015, a Government "No Go Zone"

Rita Kusi

Community Liaison, Ghana National Catholic Health Service
Building Bridges Between the Government and Community

Panels *(continued)*

12:15 p.m. - 1:30 p.m. Rhode Island

Have Anti-Corruption Measures Failed? Why?

Global Public Administration

Endorsed By:

Section on Chinese Public Administration, Section on Democracy and Social Justice and Section on Ethics and Integrity in Governance

MODERATOR

Yahong Zhang

Associate Professor, Rutgers University—Newark

DISCUSSANT

Kimberly Nelson

Associate Professor, University of North Carolina—Chapel Hill

PRESENTERS

Denis Guimarães

Partner, AGPR—Law, Policy and Advocacy
Corruption Investigations, Politicization and Institutional Crises? A Comparative Politics, Policy and Law Approach

David Janesics

Assistant Professor, San Diego State University
Corruption as Resource Transfer: An Interdisciplinary Synthesis

Paul Lagunes

Assistant Professor, Columbia University
The Watchful Eye and the Cracking Whip: Field Experiments on Corruption Control

PRESENTERS/COAUTHORS

Xianqiang Cao

Professor, Shandong University
The Determinants of Corruption Perception Variation Toward Different Government Levels in China

Zongfeng Sun

Assistant Professor, Shandong University—Qingdao
The Determinants of Corruption Perception Variation Toward Different Government Levels in China

Sunny Yang

Postdoctoral Fellow, City University of Hong Kong
Patterns of Anti-Corruption Innovation: A Review of 460 Cases in Local China

COAUTHOR

Zhang Yue

Senior Research Assistant, City University of Hong Kong
Patterns of Anti-Corruption Innovation: A Review of 460 Cases in Local China

12:15 p.m. - 1:30 p.m.

Maryland

Collaborative Health Governance

Global Public Administration

Endorsed By:

Section on Complexity and Network Studies and Section on Health and Human Services Administration

PRESENTERS

Kun Huang

Associate Professor, University of New Mexico
The Effect of Centralized Network Governance on Joint Administrative Advocacy in a Health and Human Services Network

Judy Xu

Professor, Southwestern University of Finance and Economics
Public, Value-Based, Collaborative Health Governance Assessment Framework

PRESENTERS/COAUTHORS

Wenlan Dong

Chinese Center for Disease Control and Prevention
Demonstration Program for Comprehensive Prevention and Control of NCDs in China: A Governmental Action

Wilma Jansen

Erasmus Medical Center
Academic Working Places' Model to Improve Collaboration Between Public Administration, Social and Health Care Practice and University Research

Shiwei Liu

Professor, Chinese Center for Disease Control and Prevention
Demonstration Program for Comprehensive Prevention and Control of NCDs in China: A Governmental Action

Hein Raat

Professor, Erasmus Medical Center
Academic Working Places' Model to Improve Collaboration Between Public Administration, Social and Health Care Practice and University Research

Panels *(continued)*

Amy Van Grieken

Societal Development, City of Rotterdam
Academic Working Places' Model to Improve Collaboration Between Public Administration, Social and Health Care Practice and University Research

Denis Wiering

Program Manager, Societal Development, City of Rotterdam
Academic Working Places' Model to Improve Collaboration Between Public Administration, Social and Health Care Practice and University Research

Workshop

12:15 p.m. - 1:30 p.m. Pennsylvania

Enabling Success for All Students: Examining School Finance and Funding with an Equity Lens through All Levels of Government

Public Finance

Endorsed By:

Section on Democracy and Social Justice and Section on Ethics and Integrity in Governance

CONVENER

Ella Krivitchenko

Communications Specialist, Washington, DC Public Charter School Board

PRESENTERS

Neil Danberg

Budget Analyst, White House Office of Management and Budget

Lin Johnson

Chief Financial Officer, Shelby County Schools

Ozoemena Nnamadim

School Finance Analyst, Washington, DC Public Charter School Board

Tracy Schober

Admissions Administrator, Anderson Center for Autism
Transforming the Admission Process: Optimizing Quality of Life for Families and Employees

Panels

12:15 p.m. - 1:30 p.m.

New York

Fiscal Issues in Public Administration

Public Finance

PRESENTERS

Taejun Lee

Associate Professor, KDI School of Public Policy and Management
An Investigation of Financial Disclosure and Financial Literacy in Citizens' Financial Behavior

Linda Nguyen

Associate Vice President, Community Development, Wells Fargo
Public-Private Partnerships: We Are Only as Strong as Our Communities

Urszula Zawadzka-Pak

Assistant Professor, University of Bialystok
Shaping Financial Accountability via Public Values: A Case Study of Participatory Budgeting in Poland

PRESENTERS/COAUTHORS

Jun Ki Lee

Doctoral Student, Florida State University
A Study of Public-Public Partnerships in Government Contracts in Florida

Yu Shi

Assistant Professor, University of North Texas
District Reliance by Service Function: A Study of Public Financing of American Special-Function Jurisdictions

COAUTHORS

William Klay

Professor, Florida State University
A Study of Public-Public Partnerships in Government Contracts in Florida

HyungGun Park

Doctoral Student, University of North Texas
District Reliance by Service Function: A Study of Public Financing of American Special-Function Jurisdictions

Panels *(continued)*

12:15 p.m. - 1:30 p.m.

Massachusetts

Government Finances through Future Cycles

Public Finance

Endorsed By:

Association for Budgeting and Financial Management and
Section on Public Administration Research

MODERATOR/COAUTHOR

John Bartle

Dean and Professor, University of Nebraska—Omaha
The Future of State and Local Government Finances

PRESENTERS/COAUTHORS

Bradley Chilton

Professor and Director, University of Texas at El Paso
*You've Got Just What I Need: South Dakota v. Wayfair
Inc. (2018), Sales Taxes and Digital Information Ethics
for Bureaucrats*

Yilin Hou

Professor, Syracuse University
*The Impact of Frequent Property Reassessment on
Assessment Outcomes*

David Kanaan

Assistant Professor, San Diego State University
*Dedicated Local Option Sales Taxes: Did They Make a
Difference in Post-Recession Texas Municipalities?*

Yusun Kim

Doctoral Student, Syracuse University
*The Impact of Frequent Property Reassessment on
Assessment Outcomes*

Skip Krueger

Associate Professor, University of North Texas
*The Political Business Cycle of State Government
Revenue Choice*

HyungGun Park

Doctoral Student, University of North Texas
*The Political Business Cycle of State Government
Revenue Choice*

James Woods

Research Scientist, Administrative Office of the U.S.
Courts
*You've Got Just What I Need: South Dakota v. Wayfair
Inc. (2018), Sales Taxes and Digital Information Ethics
for Bureaucrats*

Yan Xiao

Assistant Professor, California State University—Fullerton
The Future of State and Local Government Finances

COAUTHORS

Jeremy Hall

Co-Editor in Chief, *Public Administration Review*, and
Professor and MPA Director, University of Central Florida
*Dedicated Local Option Sales Taxes: Did They Make a
Difference in Post-Recession Texas Municipalities?*

Stephen King

Professor, Regent University
*You've Got Just What I Need: South Dakota v. Wayfair
Inc. (2018), Sales Taxes and Digital Information Ethics
for Bureaucrats*

12:15 p.m. - 1:30 p.m.

Virginia

The Latest on Leadership

Public Service

Endorsed By:

Section on Emergency and Crisis Management, Section
on Public Administration Research and Students and New
Administration Professionals Section

MODERATOR/PRESENTER

Matthew Fairholm

Professor, University of South Dakota
*Influence, Subtlety and Leadership in a Volunteer
Organization's Steering Committee*

PRESENTER

Scott Drexler

Lead Emergency Management Specialist, U.S.
Department of Health and Human Services
*Own the Moment: Cultivating Mindful Leadership in
Emergency Response*

PRESENTERS/COAUTHORS

Adela Ghadimi

Doctoral Student, Florida State University
*Advancing Alternative Leadership Skills to Empower the
Middle Ranks and Develop Future Leaders*

Zeeshan Noor

Doctoral Student and Research Assistant, University of
Texas at Dallas
*Leadership and Online Fundraising in the Nonprofit
Sector*

Panels *(continued)*

Jesus N. Valero

Assistant Professor, University of Utah
Understanding the Leadership Style of Network Managers: Are There Differences Between Public and Nonprofit Leaders?

COAUTHORS

Ralph Brower

Professor, Florida State University
Advancing Alternative Leadership Skills to Empower the Middle Ranks and Develop Future Leaders

James Harrington

Assistant Professor, University of Texas at Dallas
Leadership and Online Fundraising in the Nonprofit Sector

Hee Soun Jang

Associate Professor and Assistant Chair, University of North Texas
Understanding the Leadership Style of Network Managers: Are There Differences Between Public and Nonprofit Leaders?

Jihoon Jeong

Doctoral Student, University of North Texas
Understanding the Leadership Style of Network Managers: Are There Differences Between Public and Nonprofit Leaders?

12:15 p.m. - 1:30 p.m.

New Hampshire

Collaboration in Public Service

Public Service

Endorsed By:

Section on Complexity and Network Studies, Section on Emergency and Crisis Management, Section on Health and Human Services Administration and Section on Intergovernmental Administration and Management

PRESENTERS

Brendan Burke

Associate Professor, Suffolk University
Specifying Success in "Promise Neighborhood" Networks: Measurement of Collaborative Processes and Outcomes

Razilya Shakirova

Doctoral Student, Rutgers University
An Investigation into Governance and Outcomes of Nonprofit Collaborative Networks

PRESENTERS/COAUTHORS

Hee Soun Jang

Associate Professor and Assistant Chair, University of North Texas
A Study of Cross-Sector Collaboration for Homeless Medical Services: Effective Collaboration Measured and Tested

Yana Lu

Professor, Nanjing Normal University
Analysis of Factors Influencing Collaboration Between Government and NGOs in Disaster Relief: Evidence from China

Yuan Ting

Professor, California State University—Fullerton
Analysis of Factors Influencing Collaboration Between Government and NGOs in Disaster Relief: Evidence from China

Jesus N. Valero

Assistant Professor, University of Utah
A Study of Cross-Sector Collaboration for Homeless Medical Services: Effective Collaboration Measured and Tested

Federickia Washington

Doctoral Student, University of North Texas
A Study of Cross-Sector Collaboration for Homeless Medical Services: Effective Collaboration Measured and Tested

COAUTHORS

Susannah Ali

Assistant Professor, Florida International University
Advancing Public Service Impact: The Missing Link in Collaboration Theory—Connecting Motivation to Successful Outcomes

Jihoon Jeong

Doctoral Student, University of North Texas
A Study of Cross-Sector Collaboration for Homeless Medical Services: Effective Collaboration Measured and Tested

Panels *(continued)*

12:15 p.m. - 1:30 p.m. South Carolina

Ethics in Action

Public Service

Endorsed By:

Association for Budgeting and Financial Management,
Section on Democracy and Social Justice and Section on
Ethics and Integrity in Governance

MODERATOR

Aziza Zemrani

Associate Professor and Chair, University of Texas at Rio
Grande Valley

MODERATOR/PRESENTER

Cynthia Lynch

Associate Professor, Hawaii Pacific University
*A Call for a "Public Administration Ethicist" Career
Destination*

PRESENTER

Peter Cruise

Executive Director, LeRoy Collins Public Ethics Academy,
Florida Atlantic University
Serving the Community: Lessons Learned

PRESENTERS/COAUTHORS

Thomas Lynch

Reverend Dr., International Academy of Interfaith
Studies
*A Call for a "Public Administration Ethicist" Career
Destination*

Merrett Stierheim

Miami-Dade County Manager (Retired) and Chair, LeRoy
Collins Public Ethics Academy Advisory Board
Serving the Community: Lessons Learned

Past Presidents' Luncheon

12:15 p.m. - 2:00 p.m. District Ballroom

(By Invitation)

Exhibit Hall Open

12:30 p.m. - 6:30 p.m. State and East Rooms

Presidential Panel

1:45 p.m. - 3:00 p.m. Chinese Ballroom

The New Financial Sustainability Framework

Public Finance

MODERATOR

Shayne Kavanagh

Senior Manager, Research, Government Finance Officers
Association

PRESENTERS

Laura Allen

Town Administrator, Town of Berlin, Maryland

Mark Pisano

Professor of Practice of Public Administration, Price
School of Policy, University of Southern California

Shui-Yan Tang

Professor, University of Southern California

Section Leadership Meeting

3:15 p.m. - 4:30 p.m. Independence

PRESENTERS

Michael Ahn

Associate Professor, University of Massachusetts—Boston
and Visiting Professor (2017-2018), Seoul National
University

Lauren Bock Mullins

Assistant Professor, Long Island University

Chad Miller

Professor, University of Southern Mississippi

Panels

3:15 p.m. - 4:30 p.m. New Hampshire

Big Questions for Public Administration in the Age of Conviction Politics, Presidential Populism and Neo-Globalization

Global Public Administration

Endorsed By:
International Chapter, Section on Public Administration Research and Students and New Administration Professionals Section

MODERATOR/PRESENTER

Ali Farazmand

Professor, Florida Atlantic University
Big Questions for Public Administration in the Age of Conviction Politics, Presidential Populism and Neo-Globalization

DISCUSSANT/COAUTHOR

James Pfiffner

University Professor, George Mason University

PRESENTERS

Donald Kettl

Professor, University of Texas at Austin
Public Branding in a Globalized World

Jos Raadschelders

Professor and Associate Dean, Ohio State University
Challenges of Governing Democratic Regimes: Public Administration as a Counterweight to Populism, Partisan Politics and Rent-Seeking

Tatiana Zaytseva

Professor and Director, International Relations Department, Moscow State University
Civil Service Legislation vs. Public Human Resources Management: Control vs. Flexibility

PRESENTER/COAUTHOR

David Rosenbloom

Distinguished Professor, American University and Chinese Thousand Talents Program Professor, Renmin University of China
Presidential Public Management and the Erosion of the Rule of Law in the United States: Bush (43), Obama and Trump

3:15 p.m. - 4:30 p.m.

New Jersey

Network Governance in China and the United States

Global Public Administration

Endorsed By:
Association for Budgeting and Financial Management, International Chapter, Section on Chinese Public Administration, Section on Complexity and Network Studies, Section on Intergovernmental Administration and Management and Section on Public Administration Research

MODERATOR/PRESENTER

Robin Lemaire

Associate Professor, Virginia Tech
Forcing, Incentivizing and Nudging: Network Administrative Organizations and the Tri-Governance of Mandated Public Networks

PRESENTER

Zhichao Li

Associate Professor, East China University of Political Science and Law
The Changes of Fertility Policies from "One-Child Policy" to "Universal Two-Child Policy": A Discourse Network Analysis Based on Discourse Coalition

PRESENTERS/COAUTHORS

Lauren McKeague

Doctoral Student, Virginia Tech
Forcing, Incentivizing and Nudging: Network Administrative Organizations and the Tri-Governance of Mandated Public Networks

Qiushi Wang

Associate Professor, Sun Yat-sen University
Public Pension Boards' External Ties and Actuarial Assumptions: A Relational Perspective

Yao Xiong

Doctoral Student, Southwestern University of Finance and Economics
A Social Network Analysis of Policy Actors and Evolution in China's Five-Year Health Care Plans (1986-2017)

Judy Xu

Professor, Southwestern University of Finance and Economics
A Social Network Analysis of Policy Actors and Evolution in China's Five-Year Health Care Plans (1986-2017)

Panels (continued)

COAUTHOR

Kun Huang

Associate Professor, University of New Mexico
Public Pension Boards' External Ties and Actuarial Assumptions: A Relational Perspective

3:15 p.m. - 4:30 p.m.

Virginia

Governance Challenges in Public Service: Structural, Behavior and Performance Studies in East Asia

Global Public Administration

Endorsed By:

Section on Chinese Public Administration, Section on Complexity and Network Studies and Section on Public Performance and Management

MODERATOR/COAUTHOR

Kuotsai Liou

Professor, University of Central Florida
How Corruption and Integrity Management Influence the Attitudes of Public Employees: The Role of Job Clarity and Organizational Trust

DISCUSSANTS

Stephen Condrey

President, Condrey and Associates Inc.

Andrew Podger

Honorary Professor, Australian National University

PRESENTER

Kwangho Jung

Professor, Seoul National University
Challenges for Learning Activities and Capacities: Relocation and Separation of Central Government Organizations as a Natural Experiment in the Republic of Korea

PRESENTERS/COAUTHORS

Jun Yi Hsieh

Professor, University of Taipei
How Corruption and Integrity Management Influence the Attitudes of Public Employees: The Role of Job Clarity and Organizational Trust

Gary Schwarz

Reader, Public Policy and Management, University of London
The Performance Effects of Network Governance Leadership: Evidence from the Chinese Public Sector

Jiannan Wu

Distinguished Professor and Executive Vice Dean, Shanghai Jiaotong University
Performance Goal Setting, Interlocal Collaboration and Air Pollution Control: Evidence from China's Air Pollution Prevention and Control of Key Regions

Mengmeng Xu

Doctoral Student, Xi'an Jiaotong University
Performance Goal Setting, Interlocal Collaboration and Air Pollution Control: Evidence from China's Air Pollution Prevention and Control of Key Regions

COAUTHORS

Nathan Eva

Senior Lecturer, Monash University
The Performance Effects of Network Governance Leadership: Evidence from the Chinese Public Sector

Quan-Jing Hong

MPA Student, University of Taipei
How Corruption and Integrity Management Influence the Attitudes of Public Employees: The Role of Job Clarity and Organizational Trust

Alexander Newman

Professor, Deakin University
The Performance Effects of Network Governance Leadership: Evidence from the Chinese Public Sector

3:15 p.m. - 4:30 p.m.

Maryland

Toward Good Governance in China

Global Public Administration

Endorsed By:

Association for Budgeting and Financial Management, International Chapter and Section on Chinese Public Administration

MODERATOR

Zhirong Zhao

Associate Professor, University of Minnesota

DISCUSSANT

Kuotsai Liou

Professor, University of Central Florida

PRESENTERS

Mi Jianing

Professor, Harbin Institute of Technology
"Big Data"-Driven Public Management Research Transformation and Its Discipline Modernization

Panels *(continued)*

Kaifeng Yang

Dean and Professor, School of Public Administration and Policy, Renmin University of China
Explaining Citizens' "Good Governance" Perceptions: The Case of Chinese Cities

PRESENTERS/COAUTHORS

Biao Huang

Student, Chinese University of Hong Kong
Experiences and Prospects of "Complete in One Go" Government Reform in Zhejiang Province

Chenguang Li

Lecturer, Nankai University
A Comparative Analysis on the Sustainable Urban Neighborhoods in China and India: Taking ChongQing, DaTong and Delhi and Madurai as Examples

Tao Sun

Dean, Nankai University
A Comparative Analysis on the Sustainable Urban Neighborhoods in China and India: Taking ChongQing, DaTong and Delhi and Madurai as Examples

Chongying Wang

Associate Professor, Nankai University
A Comparative Analysis on the Sustainable Urban Neighborhoods in China and India: Taking ChongQing, DaTong and Delhi and Madurai as Examples

Jianxing Yu

Dean, Zhejiang University
Experiences and Prospects of "Complete in One Go" Government Reform in Zhejiang Province

3:15 p.m. - 4:30 p.m.

Rhode Island

Accountability at the Center of Public Finance and Public Service

Public Finance

Endorsed By:
Association for Budgeting and Financial Management

MODERATOR/PRESENTER

Jonathan Justice

Professor, University of Delaware
Debt Reckoning: Public Accountability and Public Finance

DISCUSSANT/PRESENTER

Melvin Dubnick

Professor, University of New Hampshire
A Funny Thing Happened on the Way to the Forum©: Adam Smith, Chester Barnard and the "Emergence" of Accountability

3:15 p.m. - 4:30 p.m.

Pennsylvania

Impacts of Government Management Form, Capacity and Quality

Public Finance

Endorsed By:
Association for Budgeting and Financial Management and Section for Women in Public Administration

MODERATOR/COAUTHOR

Gina Scutelnicu

Assistant Professor, Pace University
How Effective is the Tax Treatment of Public Authorities? Examining Industrial Development Agencies in New York

PRESENTERS

Paul Chalekian

Manager, POSDCORB LC University of Nevada—Reno
Legitimizing Public Administration: The Patterning of an Artifact

Imane Hijal-Moghrabi

Assistant Professor, University of Texas at Permian Basin
The Scope and Patterns of Implementation of Performance-Based Budgeting in the Largest Cities in Texas

Iuliia Shybalkina

Doctoral Student, Syracuse University
Property Assessment Appeals and Their Effect on the Vertical Equity of Property Taxes: Institutions Matter

PRESENTERS/COAUTHORS

Andrew Crosby

Assistant Professor, Pace University
How Effective is the Tax Treatment of Public Authorities? Examining Industrial Development Agencies in New York

Thomas Greitens

Professor, Central Michigan University
American Administrative Capacity: Decline, Decay and Resilience

Panels *(continued)*

Ernita Joaquin

Associate Professor, San Francisco State University
American Administrative Capacity: Decline, Decay and Resilience

Jinsol Park

Doctoral Student, University of Kentucky
Does Quality of Financial Management Increase the Quality of Municipal Bond Credit Ratings?

COAUTHORS

Dwight Denison

Professor, University of Kentucky
Does Quality of Financial Management Increase the Quality of Municipal Bond Credit Ratings?

Hakyeon Lee

Doctoral Student, University of Kentucky
Does Quality of Financial Management Increase the Quality of Municipal Bond Credit Ratings?

3:15 p.m. - 4:30 p.m.

New York

Education and Nonprofit Financing Issues

Public Finance

Endorsed By:

Section for Women in Public Administration

MODERATOR/PRESENTER

Lilia Silverio Minaya

Assistant Dean of Students and Executive Director, Finance and Human Resources, Florida International University
Higher Education Performance-Based Funding: Determinants of Adoption and Stringency in the United States

PRESENTERS

Chuanyi Guo

Doctoral Student, University of Illinois—Chicago
The Impact of State Intervention on School District Fiscal Performance: Evidence from a Regression Discontinuity Design

Trang Hoang

Doctoral Student, University of Texas at Dallas
Operating Reserves and Nonprofit Financial Sustainability: Cost-Benefit Analyses

Sarah Larson

Assistant Professor, University of Central Florida
Shift in Behavior: The Impact of the Nonprofit Property Tax Exemption in Florida

PRESENTERS/COAUTHORS

Jiahuan Lu

Assistant Professor, Rutgers University—Newark
Do Nonprofit Organizations Diversify Their Revenue Sources over Time?

Jianzhi Zhao

Assistant Professor, Fudan University
Do Nonprofit Organizations Diversify Their Revenue Sources over Time?

3:15 p.m. - 4:30 p.m.

Massachusetts

NAPA Session—Grand Challenges in Public Administration in the 2020s: The View from Multiple Sectors

Public Service

MODERATOR

Teresa Gerton

President, National Academy of Public Administration

PRESENTERS

Matthew Chase

Executive Director, National Association of Counties
Local Government Perspectives

Laurel McFarland

Executive Director, Network of Schools of Public Policy, Affairs, and Administration
University Perspectives

Marcia McNutt

President, National Academy of Sciences
Science, Technology, Engineering and Math Perspectives

Panels *(continued)*

3:15 p.m. - 4:30 p.m.

Senate

Public Integrity 20th Anniversary Symposium

Public Service

Endorsed By:

Section for Women in Public Administration, Section on Democracy and Social Justice, Section on Ethics and Integrity in Governance and Section on Public Administration Research

MODERATOR

Terry Cooper

Maria B. Crutcher Professor in Citizenship and Democratic Values, University of Southern California

DISCUSSANT

Carole Jurkiewicz

Professor, Ethics and Public Integrity, University of Colorado Colorado Springs and Affiliate and Principal, Jurkiewicz and Associates, LLC

PRESENTERS

Brian Cook

Professor, Virginia Tech
Restraining the Energetic Executive: Can Administrators Legitimately Check Presidential Power?

Schnequa Diggs

Assistant Professor and MPA Coordinator, California State University—East Bay
Reclaiming My Time: Disparities for Women Leaders in Government

Richard Hough

Public Administration Program, University of West Florida
Administrative Evil and the Use of Deadly Force in Law Enforcement

3:15 p.m. - 4:30 p.m.

South Carolina

What Will Government Look Like in 2040?

Public Service

Endorsed By:

Section on Complexity and Network Studies, Section on Intergovernmental Administration and Management and Section on Public Administration Research

MODERATOR/DISCUSSANT

John Kamensky

Senior Fellow, The IBM Center for The Business of Government

PRESENTERS

Lora Frecks

Doctoral Student, University of Nebraska—Omaha
Engaged Government: Five Predictions for 2040

Lori Gordon

Civil Systems Protection Leader, The Aerospace Corporation
Networked Government: Managing Data, Knowledge and Services

Sukumar Rao

President, The Parnin Group
A Citizen-Led Network of Borderless Organizations

3:15 p.m. - 4:30 p.m.

North Carolina

Students and New Administration Professionals Section Job Market Show Case

Public Service

Endorsed By:

Section on Public Law and Administration and Students and New Administration Professionals Section

PRESENTERS

Pallavi Awasthi

Doctoral Student, Florida International University
Enhancing Organizational Social Capital in Local U.S. Governments: A Servant Leadership Approach

Nicole Humphrey

Doctoral Student, University of Kansas
Testing the Relationship Between Emotional Labor and Social Capital

Christina Sarrafian

Student and Traffic Coordinator, West Chester University of Pennsylvania and Comcast
Public Service Motivation in Law Enforcement Officers

Srinivas Yerramsetti

Doctoral Student, Rutgers University—Newark
Targeting Cooking Gas Benefits in India: Investigating Administrative Burden and Policy Feedbacks

COAUTHOR

Romeo Abraham

Doctoral Student and Teaching Assistant, University of Texas at Dallas
The Enhancing Effect of Employee Engagement on Work Behaviors and Performance Ratings in Federal Employees

Social Equity, Diversity and Inclusion Workshop

4:00 p.m. - 7:00 p.m.

Chinese Ballroom

Social Equity

This Session is Co-Sponsored By:
Conference of Minority Public Administrators, LGBT Advocacy Alliance, Section for Women in Public Administration, Section on Democracy and Social Justice, Section on Health and Human Services Administration, Section on Personnel Administration and Labor Relations and Student and New Administration Professionals Section

CONVENERS

Rashmi Chordiya

Assistant Professor, Seattle University

Nicole Elias

Assistant Professor, John Jay College of Criminal Justice

Sean McCandless

Assistant Professor, University of Illinois—Springfield

PRESENTERS

Brandi Blessett

Associate Professor of Political Science, University of Cincinnati

Tia Sherèe Gaynor

Assistant Professor of Political Science, University of Cincinnati

Panels

4:45 p.m. - 6:00 p.m.

New Hampshire

The Role of Local Governments in United States and European Regional Governance

Global Public Administration

Endorsed By:
International Chapter, Section on Complexity and Network Studies and Section on Intergovernmental Administration and Management

MODERATOR/PRESENTER

Thomas Skuzinski

Assistant Professor, Virginia Tech
Local Autonomy and Development Policy in Mid-Size Appalachian Regions in the United States

PRESENTERS/COAUTHORS

Austin Aldag

Doctoral Student, Cornell University
State Rules and Local Reality: Evidence from Interlocal Cooperation in New York State

Haris Alibasic

Assistant Professor, University of West Florida
Applying the Institutional Collective Action Framework to Intermunicipal Cooperation in Bosnia and Herzegovina

Petra Ophoff

Researcher, Netherlands School of Public Administration
Emergent and Mandated Regional Labor Market Collaborations: What Kind of Collaborative Logics Do They Establish?

COAUTHORS

Lachezar Anguelov

Assistant Professor, The Evergreen State College
Applying the Institutional Collective Action Framework to Intermunicipal Cooperation in Bosnia and Herzegovina

Mildred Warner

Professor, Cornell University
State Rules and Local Reality: Evidence from Interlocal Cooperation in New York State

4:45 p.m. - 6:00 p.m.

South Carolina

The Globalization and Politicization of Migration: Balancing Domestic and International Challenges

Global Public Administration

Endorsed By:
International Chapter, Section on Emergency and Crisis Management and Section on Ethics and Integrity in Governance

MODERATOR

Jean-Claude Garcia-Zamor

Professor, Florida International University

DISCUSSANT

Ariane Chebel D'Apollonia

Professor, Rutgers University—Newark

Panels *(continued)*

PRESENTERS

Saltanat Liebert

Associate Professor, Virginia Commonwealth University
Integration of Post-Soviet Immigrants in the United States: The Case of Kyrgyz Labor Migrants

Jungwon Yeo

Assistant Professor, University of Central Florida
Beyond Gatekeeping: Unleashing Collaborative Networks for Border Management

PRESENTERS/COAUTHORS

Jennica Larrison

Assistant Professor, University of Baltimore
Understanding Migration: The Case for a Public Administration Lens

Michele Tantardini

Assistant Professor, Penn State Harrisburg
The Politics of Refugee Crisis Management: Does Performance Matter?

COAUTHOR

Jos Raadschelders

Professor and Associate Dean, Ohio State University
Understanding Migration: The Case for a Public Administration Lens

4:45 p.m. - 6:00 p.m.

Rhode Island

Public Finance in an Uncertain Environment in Asia

Public Finance

Endorsed By:

International Chapter, Section on Chinese Public Administration and Section on Democracy and Social Justice

MODERATOR/COAUTHOR

Alfred Muluan Wu

Associate Professor, Lee Kuan Yew School of Public Policy, National University of Singapore
Chinese Solidarity Tax in the Making? Paradigms, Models and Policy Implications

PRESENTERS

Zhenzhen Wang

Renmin University of China
Do Social Security Expenditures Promote Social Equity and Justice? An Empirical Study from Mainland China

Chengwei Xu

Research Fellow, Singapore Management University
International Tax Competition, Capital Mobility and Inequality: Empirical Evidence from Asia-Pacific Economies

PRESENTER/COAUTHOR

Hui Li

Assistant Professor, National University of Singapore
Property Tax, Home Purchase Restriction, Expectation and Housing Price: An Empirical Study of 35 Large- and Medium-Sized Cities in China

Na Zhou

Visiting Research Fellow, East Asian Institute, National University of Singapore
Chinese Solidarity Tax in the Making? Paradigms, Models and Policy Implications

4:45 p.m. - 6:00 p.m.

New Jersey

Fiscal Health: From Sustainability and Stabilization to Pension and Debt

Public Finance

Endorsed By:

Association for Budgeting and Financial Management

MODERATOR/PRESENTER

Kenneth Kriz

University Distinguished Professor, University of Illinois—Springfield
Measuring Fiscal Sustainability of Local Governments: A Stress Testing Approach Using Illinois Municipalities

PRESENTERS

Heidi Jane Smith

Professor, Universidad Iberoamericana
Over-Indebted Subnational Mexico: Does Political Polarization Affect Debt Policy Decisions?

Odd Stalebrink

Associate Professor, Penn State Harrisburg
Public Pension Funds and Risk-Taking Behavior: An Analysis of Noncompliance with Critical Funding Targets

PRESENTERS/COAUTHORS

Vincent Reitano

Assistant Professor, Western Michigan University
A Causal Approach to Examining Budget Stabilization over the Business Cycle

Panels *(continued)*

Kent Robinson

Assistant Professor, Portland State University
A Method for Assessing the Fiscal Health of Oregon Rural Local Governments

COAUTHOR

Paul Manson

Senior Research Assistant, Portland State University
A Method for Assessing the Fiscal Health of Oregon Rural Local Governments

Workshop

4:45 p.m. - 6:00 p.m. Independence

NASPAA Site Visitor Training

Public Service

MODERATOR/PRESENTER

Heather Hamilton

Director of Assessment and Accreditation Manager,
Network of Schools of Public Policy, Affairs, and
Administration

PRESENTER

Crystal Calarusse

Chief Accreditation Officer, Network of Schools of Public
Policy, Affairs, and Administration

Panels

4:45 p.m. - 6:00 p.m. Pennsylvania

Entrepreneurial Governance

Public Service

Endorsed By:

Section on Emergency and Crisis Management and
Section on Public Administration Research

MODERATOR/PRESENTER

John Carroll

Associate Professor, Nova Southeastern University
*An Idea Untried Will Always Fail: Entrepreneurial
Governance Theory to Practice*

PRESENTERS/COAUTHORS

Li Cheng

Deputy Director, Sichuan Provincial Development and
Reform Commission
*The Role of the Policy Entrepreneur in Local Policy
Innovation: A Study of Post-Disaster Reconstruction in
an Authoritarian Country*

Eunmi Choi

Doctoral Student, Rutgers University—Newark
*Representative Bureaucracy and Entrepreneurship in
Public Schools*

Sophia Hong

Doctoral Student, Renmin University of China
*Public Entrepreneurship and Government Innovation:
An Empirical Analysis of Local Government in China*

Yichen Hong

Doctoral Student, Renmin University of China and
American University
*Public Entrepreneurship and Government Innovation:
An Empirical Analysis of Local Government in China*

David Rosenbloom

Distinguished Professor, American University and
Chinese Thousand Talents Program Professor, Renmin
University of China
*Public Entrepreneurship and Government Innovation:
An Empirical Analysis of Local Government in China*

Geiguen Shin

Postdoctoral Research Fellow, Rutgers University—
Newark
*Representative Bureaucracy and Entrepreneurship in
Public Schools*

Na Tang

Assistant Professor, Huazhong University of Science and
Technology
*The Role of the Policy Entrepreneur in Local Policy
Innovation: A Study of Post-Disaster Reconstruction in
an Authoritarian Country*

Panels *(continued)*

4:45 p.m. - 6:00 p.m.

North Carolina

Performance Management Issues in Public Administration

Public Service

Endorsed By:

Section on Health and Human Services Administration and Section on Public Performance and Management

MODERATOR/PRESENTER

Robin Kempf

Assistant Professor, John Jay College of Criminal Justice, City University of New York
Assessing Offices of Inspectors General

PRESENTERS/COAUTHORS

Abigail Beatty

Performance Analyst, King County Office of Performance, Strategy and Budget
An Evaluation of King County's Performance Management Approach: Improving Adoption of Lean Visual Management Tools

Cathleen Buzan

Performance and Strategy Coordinator, King County Road Services Division
An Evaluation of King County's Performance Management Approach: Improving Adoption of Lean Visual Management Tools

Benjamin Licht

Assistant Director, U.S. Government Accountability Office
Achieving More Efficient and Effective Results by Improving Data-Driven Decisionmaking in Government

Adam Miles

Senior Analyst, U.S. Government Accountability Office
Achieving More Efficient and Effective Results by Improving Data-Driven Decisionmaking in Government

Allison Thompson

International City/Council Managers Association Fellow, City of Fort Lauderdale
An Evaluation of King County's Performance Management Approach: Improving Adoption of Lean Visual Management Tools

Fei Wang

Doctoral Student, American University
The Impact of the CMS National Background Check Program on Performance in U.S. Nursing Homes

Alexandra Woodward

Leadership Strategist (Management Analyst 5), Washington Department of Labor and Industry
An Evaluation of King County's Performance Management Approach: Improving Adoption of Lean Visual Management Tools

COAUTHORS

Anna Amirkhanyan

Associate Professor, American University
The Impact of the CMS National Background Check Program on Performance in U.S. Nursing Homes

Jourdan Davis

Doctoral Student, American University
The Impact of the CMS National Background Check Program on Performance in U.S. Nursing Homes

Kenneth Meier

Distinguished Scholar in Residence, American University
The Impact of the CMS National Background Check Program on Performance in U.S. Nursing Homes

Priti Mody-Pan

Senior Performance and Strategy Analyst, King County Office of Performance, Strategy and Budget
An Evaluation of King County's Performance Management Approach: Improving Adoption of Lean Visual Management Tools

Lucy Sorensen

Assistant Professor, University at Albany, The State University of New York
How Do Accountability Systems Affect Front-Line Public Service Empowerment? Evidence from North Carolina Teachers

4:45 p.m. - 6:00 p.m.

Maryland

The Value of Public Service

Public Service

Endorsed By:

Section for Women in Public Administration, Section on Democracy and Social Justice, Section on Public Administration Research and Students and New Administration Professionals Section

MODERATOR

Robert Tobias

Distinguished Practitioner in Residence, American University

Panels *(continued)*

PRESENTERS

David Chu

President and CEO, Institute for Defense Analyses

Mortimer Downey

President, Mort Downey Consulting

Dave Mader

Civilian Sector Chief Strategy Officer, Deloitte & Touche

4:45 p.m. - 6:00 p.m.

Senate

Celebrating Minnowbrook at 50: Social Equity Past, Present and Future

Social Equity

Endorsed By:

Section for Women in Public Administration, Section on Democracy and Social Justice, Section on Public Administration Research and Students and New Administration Professionals Section

MODERATORS

Susan T. Gooden

Interim Dean and Professor, L. Douglas Wilder School of Government and Public Affairs, Virginia Commonwealth University

Tina Nabatchi

Associate Professor, Syracuse University

PRESENTERS

Brandi Blessett

Associate Professor, University of Cincinnati

Justin Bullock

Assistant Professor, Texas A&M University

Julia Carboni

Assistant Professor, Syracuse University

Norma Riccucci

Board of Governors Distinguished Professor, Rutgers University—Newark

David Van Slyke

Dean, Syracuse University

Brian N. Williams

Associate Professor, University of Virginia

4:45 p.m. - 6:45 p.m.

New York

Astana Civil Service Hub (ACSH) Session— Modern Trends and Challenges of Public Service in Post-Soviet and Transition Countries

Global Public Administration

Endorsed By:

Association for Budgeting and Financial Management and International Chapter

MODERATORS

Alikhan Baimenov

Chairman of Steering Committee, Astana Civil Service Hub (ACSH)

Panayiotis Liverakos

Editor in Chief, *International Journal of Civil Service Reform and Practice*

DISCUSSANTS

Demetrios Argyriades

Professor, John Jay College of Criminal Justice, City University of New York

Guido Bertucci

Executive Director, Governance Solutions International

Stephen Condrey

President, Condrey and Associates Inc.

Ali Farazmand

Professor, Florida Atlantic University

Ludmila Gajdosova

Executive Director, NISPAcee

Chester Newland

Emeritus Duggan Distinguished Professor of Public Administration, University of Southern California

PRESENTERS

Adrian Ermurachi

Deputy Secretary General, Government of the Republic of Moldova

Transformation of Public Services in Moldova in the Digital Era

Jahi Jahija

State Secretary, Ministry of Information Society and Administration, FYR Macedonia

Panels *(continued)*

Saltanat Janenova

Assistant Professor, Nazarbayev University

Erzhan Kazykhanov

Ambassador to the United States, Republic of Kazakhstan

Pan Suk Kim

Former Minister of Personnel Management, Republic of Korea and Professor, Yonsei University

Volodymyr Kuprii

First Deputy Head, National Agency of Ukraine on Civil Service
Public Administration Reform in Ukraine: Progress and Priorities

Ahmad Nader Nadery

Chairman, Independent Administrative Reform and Civil Service Commission of Afghanistan
Public Administration Reform in Conflict Situations

Henadzi Palchyk

Rector, Academy of Public Administration, Republic of Belarus

William Shields, Jr.

Executive Director, American Society for Public Administration

Alik Shpekbayev

Chairman, Agency of the Republic of Kazakhstan for Civil Service Affairs and Anti-Corruption

Welcome Reception

6:30 p.m. - 8:30 p.m.

Grand Ballroom



Levin.

PUBLIC SERVICE. LEADERSHIP. CHANGE.

At Levin, you can learn to build cities, lead communities, and change your environment while immersed in a vibrant and engaging urban landscape.

Learn to change the world at Levin.

#4 IN URBAN POLICY

#13 IN LOCAL GOVERNMENT MANAGEMENT

BY U.S. NEWS & WORLD REPORT

OUR MASTERS DEGREE PROGRAMS

Master of Public Administration
Master of Urban Planning & Development
Master of Science in Urban Studies
Master of Arts in Environmental Studies
Master of Nonprofit Administration & Leadership

csuohio.edu/levin

Master of Public Administration

Advancing Public Service Through Leadership

For nearly 50 years, the UH MPA program has been the go-to graduate degree program for educating public service leaders in the Houston metro area.

Residing in Houston, the 4th largest US city and a global business leader, the UH MPA program offers students low-cost, individualized instruction, evening classes, and a rich and diverse environment.

Visit: www.uh.edu/class/mpa

UNIVERSITY of
HOUSTON

MASTER of PUBLIC ADMINISTRATION

Photo by: Michael Scott

Tailor your **Career Goals** around our 9 specialized courses



**Oil & Gas
Policy**



**Healthcare
Policy**



**Public
Management**



**Non-profit Org
Management**

and other PA and Policy Specializations

#MPAHouston

TRACKS

Global Public Administration

Infrastructure

Public Finance

Public Service

Social Equity

#ASPA2019

USC Price

Sol Price School of Public Policy

Forging solutions since 1929



ASPA PUBLIC INTEGRITY AWARD

SUNDAY, MARCH 10 | 1:30 – 3PM | GRAND BALLROOM



The USC Price School proudly honors **Terry L. Cooper**, Maria B. Crutcher Professor in Citizenship and Democratic Values, chosen to receive the 2019 ASPA Public Integrity Award.

ELLIOT RICHARDSON LECTURE

SUNDAY, MARCH 10 | 10 – 11:30AM | GRAND BALLROOM



Dean Jack H. Knott delivers the Elliot Richardson Lecture, and will lead a panel discussion afterward on public administration and democracy.

CONGRATULATIONS

- Incoming ASPA President **Paul Danczyk**, Director, Executive Education, USC Price School in Sacramento
- Professor **Robert B. Denhardt**, Professor **Janet V. Denhardt**, Professor **Maria P. Aristigueta**, and Associate Professor **Kelly Rawlings** for the fifth edition publication of their book, “Managing Human Behavior in Public and Nonprofit Organizations” (SAGE Publishing)
- **Juliet Ann Musso**, Associate Professor, named Vice Chair of the Department of Governance, Management and the Policy Process
- **Jane Pisano**, ASPA President, Professor, named Program Chair, Master of Nonprofit Leadership and Management degree program
- **William G. Resh**, for his promotion to Associate Professor
- **Shui-Yan Tang**, Frances R. and John J. Duggan Professor in Public Administration, named Chair of the Department of Governance, Management and the Policy Process

WELCOME NEW FACULTY

- **Christine M. Beckman**, joining the Price School faculty as a Visiting Professor and joining the USC Sol Price Center for Social Innovation
- **Mindy S. Romero**, joining the USC Price faculty as Research Assistant Professor and Director, California Civic Engagement Project

JOIN US AT THE USC PRICE SCHOOL RECEPTION

Sunday, March 11

6:30 – 7:30PM

Mayflower Hotel,
Rhode Island Room
Washington, D.C.

MILESTONE CELEBRATIONS

The USC Price School congratulates ASPA on 80 years of advancing public service, coinciding with the USC Price School’s 90th year anniversary celebration of excellence in public affairs education.

Ranked 2nd among 282 schools of public affairs nationwide, the USC Sol Price School of Public Policy has defined excellence and innovation in public affairs education for 90 years. The Price School is dedicated to teaching and research that advance society through better **governance**, more effective **social and health care policy**, and sustainable **urban development**.

Master of Public Administration
priceschool.usc.edu/masters/mpa

Master of Public Policy
priceschool.usc.edu/masters/mpp

Master of Nonprofit Leadership
and Management
priceschool.usc.edu/mnlm



priceschool.usc.edu

Sunday Sessions MARCH 10

TRACKS: ● Public Finance ● Infrastructure ● Social Equity ● Public Service ● Global PA

SESSION	TIME	Room
ASPA Registration Open	7:00 a.m. – 6:00 p.m.	Promenade Foyer
Alabama Chapter Meeting	7:00 a.m. – 8:15 a.m.	New York
<i>Public Administration Review</i> Editorial Board Meeting	7:00 a.m. – 8:15 a.m.	Virginia
SAPA Meeting	7:00 a.m. – 8:15 a.m.	Maryland
SCPA Deans' Roundtable	7:00 a.m. – 8:15 a.m.	Rhode Island
SDSJ Meeting	7:00 a.m. – 8:15 a.m.	Massachusetts
SNPPP Meeting	7:00 a.m. – 8:15 a.m.	North Carolina
SPALR Meeting	7:00 a.m. – 8:15 a.m.	New Jersey
SPPM Meeting	7:00 a.m. – 8:15 a.m.	New Hampshire
SSTIG Meeting	7:00 a.m. – 8:15 a.m.	Pennsylvania
● Presidential Panel–Cybersecurity: “Infrastructure” and So Much More (<i>Infrastructure Focus</i>)	8:30 a.m. – 9:45 a.m.	Chinese Ballroom
● Crisis and Emergency Management Decisionmaking	8:30 a.m. – 9:45 a.m.	New Jersey
● Water and Power Infrastructure and Governance Issues	8:30 a.m. – 9:45 a.m.	Suite 230
● Emergency Management Today: Engaging with the Community and Managing Risk	8:30 a.m. – 9:45 a.m.	New Hampshire
● Understanding Administrative Reforms in China: A Global Perspective	8:30 a.m. – 9:45 a.m.	New York
● Journal Editor Roundtable: The Challenges of Globalizing Public Administration Scholarship	8:30 a.m. – 9:45 a.m.	Rhode Island
● NIGP Session–Creating Impact through Strategic Procurement	8:30 a.m. – 9:45 a.m.	Independence
● Best Practices in Public Ethics Management: The Role of Democratic Values	8:30 a.m. – 9:45 a.m.	Virginia
● Toward Implementing Ethics: Values, Oaths, Codes and Laws	8:30 a.m. – 9:45 a.m.	Constitution
● Personnel Administration and Organizational Behavior	8:30 a.m. – 9:45 a.m.	Senate
● Leading Change in Social Equity through Planning, Research and Disseminating Information	8:30 a.m. – 9:45 a.m.	South Carolina
● Global Corruption and Ethics Management	8:30 a.m. – 9:45 a.m.	Maryland
● The Queering of a Nation	8:30 a.m. – 9:45 a.m.	Pennsylvania
● Equity in Action: Advancing Leadership for Communities of Color	8:30 a.m. – 9:45 a.m.	North Carolina
Exhibit Hall Open	9:00 a.m. – 7:00 p.m.	East and State Rooms
Elliot Richardson Lecture	10:00 a.m. – 11:30 a.m.	Grand Ballroom
Gloria Hobson Nordin Social Equity Luncheon (<i>Ticketed Event</i>)	11:45 a.m. – 1:00 p.m.	District Ballroom
● Presidential Panel–No Time to Wait (<i>Public Service Focus</i>)	11:45 a.m. – 1:00 p.m.	Chinese Ballroom
● Social Equity: Approaches and Considerations in the Asia Pacific Region	11:45 a.m. – 1:00 p.m.	New York
● Perspectives and Approaches for Promoting LGBTQ Equity	11:45 a.m. – 1:00 p.m.	Virginia
● Examining the Structures that Make or Break Equitable Decisionmaking	11:45 a.m. – 1:00 p.m.	Maryland
● Mexico and the United States: Domestic Concerns and International Relations	11:45 a.m. – 1:00 p.m.	Independence
● Environmental Policy and Management: Private Sector Entrepreneurship and Citizen Engagement	11:45 a.m. – 1:00 p.m.	Suite 230
● Exploring Similarities and Differences through the PV-GPG Framework: Assessing 40 Years of Performance Reform Between China and the United States	11:45 a.m. – 1:00 p.m.	Rhode Island
● The Future of Financing Infrastructure, Creating Jobs and Boosting Economic Development	11:45 a.m. – 1:00 p.m.	New Hampshire

MARCH 10 Sunday Sessions

TRACKS: ● Public Finance ● Infrastructure ● Social Equity ● Public Service ● Global PA

SESSION	TIME	Room
● Community Resiliency after Multiple Billion-Dollar Disasters in the United States and Abroad	11:45 a.m. – 1:00 p.m.	Senate
● Crisis and Disaster Management and Risk Communication	11:45 a.m. – 1:00 p.m.	North Carolina
● Infrastructure Management and Policies: Theoretical Frameworks, Research and Real-World Applications	11:45 a.m. – 1:00 p.m.	South Carolina
● Nuts and Bolts for Managers	11:45 a.m. – 1:00 p.m.	Pennsylvania
● Key Challenges in Conducting Performance Management	11:45 a.m. – 1:00 p.m.	New Jersey
Public Service Plenary	1:30 p.m. – 3:00 p.m.	Grand Ballroom
● Presidential Panel—University Nervous Areas of Government: Monuments and Reparations (<i>Social Equity Focus</i>)	3:15 p.m. – 4:30 p.m.	Chinese Ballroom
Founders' Fellows Panel: Improving Service Delivery in Public Sector Organizations in the U.S. and Abroad	3:15 p.m. – 4:30 p.m.	Virginia
● IIAS Panel—Trends in Public Administration Teaching and Accreditation	3:15 p.m. – 4:30 p.m.	Pennsylvania
● Urban Governance in Transitional China	3:15 p.m. – 4:30 p.m.	Maryland
● Co-Producing Better Policy Outcomes in China: Open Data, Green Energy and Bike Sharing	3:15 p.m. – 4:30 p.m.	Rhode Island
● Negotiating Successful Environmental Planning and Management	3:15 p.m. – 4:30 p.m.	North Carolina
● The Urgency of Now: Diversity and Inclusion in Emergency Management	3:15 p.m. – 4:30 p.m.	Constitution
● Accountability and Performance Management in Public Management and Collaborative Governance Networks	3:15 p.m. – 4:30 p.m.	South Carolina
● The Promises and Pitfalls of Technology in Infrastructure	3:15 p.m. – 4:30 p.m.	New Hampshire
● Infrastructure Policies, Programs and Opportunity Structures	3:15 p.m. – 4:30 p.m.	Suite 230
● State Contributions to Disaster Response	3:15 p.m. – 4:30 p.m.	New Jersey
● Dislodging Epistemic Injustice: Social Equity Imperatives	3:15 p.m. – 4:30 p.m.	Senate
● Governing Toward Social Equity	3:15 p.m. – 4:30 p.m.	New York
● ARNOVA Session—Empowering Marginalized Groups' Democratic Activism	3:15 p.m. – 4:30 p.m.	Independence
● Global Public Administration Plenary and International Assembly	4:30 p.m. – 6:30 p.m.	Grand Ballroom
<i>Chinese Public Administration Review (CPAR)</i> Journal Editors Meeting	4:45 p.m. – 6:00 p.m.	Pennsylvania
LGBT Meeting	4:45 p.m. – 6:00 p.m.	Maryland
SESAME Meeting	4:45 p.m. – 6:00 p.m.	New York
SENRA Meeting	4:45 p.m. – 6:00 p.m.	Constitution
SHHSA Meeting	4:45 p.m. – 6:00 p.m.	New Jersey
SKPA Meeting	4:45 p.m. – 6:00 p.m.	Independence
SPCM Meeting	4:45 p.m. – 6:00 p.m.	New Hampshire
STPA Meeting	4:45 p.m. – 6:00 p.m.	North Carolina
Wiley Exhibit Hall Reception	6:00 p.m. – 7:00 p.m.	State and East Rooms
Graduate School of Public and International Affairs, University of Pittsburgh Reception	6:30 p.m. – 7:30 p.m.	Senate
University of Southern California Sol Price School of Public Policy Reception	6:30 p.m. – 7:30 p.m.	Rhode Island
Women in the Public Sector, the MPA PPA and MPA IO Programs and Department of Public Management at John Jay College Reception	6:30 p.m. – 7:30 p.m.	Virginia

TRACKS: ● Public Finance ● Infrastructure ● Social Equity ● Public Service ● Global

Presidential Panel

8:30 a.m. - 9:45 a.m. Chinese Ballroom

Cybersecurity: "Infrastructure" and So Much More

Infrastructure

MODERATOR

Wendy Haynes

Special Assistant to the Vice President for University Advancement, Bridgewater State University

PRESENTERS

Amelia Estwick

Program Manager, National Cybersecurity Institute, Excelsior College

Camille Stewart

Cybersecurity Policy Fellow, New America

Panels

8:30 a.m. - 9:45 a.m. New Jersey

Crisis and Emergency Management Decisionmaking

Infrastructure

Endorsed By:

Section on Emergency and Crisis Management and Section on Environmental and Natural Resources Administration

MODERATORS/PRESENTERS

Jeffrey Stern

State Coordinator, Virginia Department of Emergency Management

Adam Thiel

Fire Commissioner, City of Philadelphia

PRESENTERS

Christa Remington

Assistant Professor, University of South Florida
Managing Employees Impacted by Disaster

Corri Zoli

Director of Research and Assistant Research Professor, Syracuse University
Terrorist Critical Infrastructures: A Public Service and Disaster Management Approach to Global Insecurity

PRESENTERS/COAUTHORS

Romeo Abraham

Doctoral Student/Teaching Assistant, University of Texas at Dallas

The Contribution of Sustainability in Ameliorating Shocks from Natural Disasters at the Local Government Level

Diana Al-Fayez

Doctoral Student, University of Texas at Dallas

The Contribution of Sustainability in Ameliorating Shocks from Natural Disasters at the Local Government Level

8:30 a.m. - 9:45 a.m.

Suite 230

Water and Power Infrastructure and Governance Issues

Infrastructure

Endorsed By:

Section on Complexity and Network Studies, Section on Democracy and Social Justice, Section on Emergency and Crisis Management, Section on Environmental and Natural Resources Administration and Section on Intergovernmental Administration and Management

PRESENTERS

Imoh Imoh-Ita

Lecturer, Akwa Ibom State University

Efficiency in Public Service Delivery in Nigeria: Lessons for Theory and Practice in the Power Sector

Qian Zhou

Assistant Professor, Xiamen University

Institutional Diversity and the SES: Diagnostic Findings from Southeast China

PRESENTERS/COAUTHORS

Ahmad Qaisi

Doctoral Student, University of North Texas

Regional Organizations and Interlocal Cooperation on Stormwater Regulation: The Case of Separate Storm/Sewer Systems

Abdul-Akeem Sadiq

Associate Professor, University of Central Florida

Participation and Nonparticipation in FEMA's Community Rating System: Insights from CRS Coordinators and Floodplain Managers

Panels (continued)

Jenna Tyler

Doctoral Student, University of Central Florida
Participation and Nonparticipation in FEMA's Community Rating System: Insights from CRS Coordinators and Floodplain Managers

Youlang Zhang

Doctoral Student, Texas A&M University
How Social Capital Shapes Citizens' Willingness to Co-Produce Public Service: Evidence from the Water Sector

COAUTHORS

Brian Collins

Chair, Associate Professor and MPA Coordinator, University of North Texas
Regional Organizations and Interlocal Cooperation on Stormwater Regulation: The Case of Separate Storm/Sewer Systems

Douglas Noonan

Professor, Indiana University—Purdue University Indianapolis
Participation and Nonparticipation in FEMA's Community Rating System: Insights from CRS Coordinators and Floodplain Managers

Jie Tao

Doctoral Student, University of North Texas
Regional Organizations and Interlocal Cooperation on Stormwater Regulation: The Case of Separate Storm/Sewer Systems

Arnold Vedlitz

Professor, Texas A&M University
How Social Capital Shapes Citizens' Willingness to Co-Produce Public Service: Evidence from the Water Sector

8:30 a.m. - 9:45 a.m.

New Hampshire

Emergency Management Today: Engaging with the Community and Managing Risk

Infrastructure

Endorsed By:

Section on Complexity and Network Studies and Section on Emergency and Crisis Management

MODERATOR/COAUTHOR

Abraham Benavides

Associate Professor and Chair, University of North Texas
Collaboration Between Emergency Management and Public Health: Issues of Contact, Connection and Association

PRESENTER

Daewoong Lee

Doctoral Student, SungKyunKwan University
Effect of Risk Communication on Risk Perception of High Risk Facilities in South Korea: The Mediating Effects of Trust in Government

PRESENTERS/COAUTHORS

Saad Alkhurayyif

Doctoral Student, University of North Texas
Using Smart Communication for Emergency and Business Information During the Hajj: Coverage in Arabic and English Media

Jisun Ryu

Doctoral Student, University of North Texas
Effect of Citizens' Risk Perception and Trust in Government, and Political Efficacy on the Civic Movement

Ismail Soujaa

Doctoral Student, University of North Texas
Collaboration Between Emergency Management and Public Health: Issues of Contact, Connection and Association

Huizeng Zhao

Doctoral Student, Xi'an Jiaotong University
Interorganizational Collaboration in Dynamic Emergency Response: A Study on Jiuzhaigou Earthquake

COAUTHORS

Mohammed Alkhurayyif

Doctoral Student, University of North Texas
Using Smart Communication for Emergency and Business Information During the Hajj: Coverage in Arabic and English Media

Panels *(continued)*

Simon Andrew

Professor, University of North Texas
Using Smart Communication for Emergency and Business Information During the Hajj: Coverage in Arabic and English Media

Xuesong Guo

Associate Professor, Xi'an Jiaotong University
Interorganizational Collaboration in Dynamic Emergency Response: A Study on Jiuzhaigou Earthquake

Young-hwan Jeon

Doctoral Student, University of North Texas
Effect of Citizens' Risk Perception and Trust in Government, and Political Efficacy on the Civic Movement

Naim Kapucu

Professor and Director, University of Central Florida
Interorganizational Collaboration in Dynamic Emergency Response: A Study on Jiuzhaigou Earthquake

Hyunwoo Lim

Doctoral Student, University of North Texas
Effect of Citizens' Risk Perception and Trust in Government, and Political Efficacy on the Civic Movement

Jia Shi

Assistant Professor, Xi'an Jiaotong University
Interorganizational Collaboration in Dynamic Emergency Response: A Study on Jiuzhaigou Earthquake

8:30 a.m. - 9:45 a.m.

New York

Understanding Administrative Reforms in China: A Global Perspective

Global Public Administration

Endorsed By:

Association for Budgeting and Financial Management, International Chapter, Section for Women in Public Administration, Section on Chinese Public Administration and Section on Public Performance and Management

MODERATOR

Kaifeng Yang

Dean and Professor, School of Public Administration and Policy, Renmin University of China

DISCUSSANT

Elaine Yi Lu

Professor and Director, John Jay College of Criminal Justice, City University of New York

DISCUSSANT/COAUTHOR

Tom Christensen

Professor, University of Oslo

PRESENTERS/COAUTHORS

Hon Chan

Professor, City University of Hong Kong
Cadre Personnel Management in SOEs: The Evolving Enterprise Nomenclatura System, 1998-2004

Mengran Chu

Doctoral Student, Renmin University of China
Rolling Back the "Provincial Supervision of Counties" Reform in Henan, China: A Resource Dependence Framework

Yan Li

Lecturer, Dalian University of Technology
How Does E-Government Service Affect Public Trust in Government? Evidence from China

Rui Mu

Associate Professor, Dalian University of Technology
How Does E-Government Service Affect Public Trust in Government? Evidence from China

Xiaoyu Xing

Doctoral Student, Renmin University of China
What Makes Governance Transformation Efforts Successful? A Comparative Case Study in China

Diyang Zhangnan

Associate Professor, Renmin University of China
Rolling Back the "Provincial Supervision of Counties" Reform in Henan, China: A Resource Dependence Framework

Lianhu Zheng

Doctoral Student, Renmin University of China
Reforming Bureaucracy in the Internet Age: The Case of the Internet Court in Hangzhou

COAUTHORS

Jie Gao

Assistant Professor, National University of Singapore
Cadre Personnel Management in SOEs: The Evolving Enterprise Nomenclatura System, 1998-2004

Panels *(continued)*

Huanming Wang

Associate Professor, Dalian University of Technology
How Does E-Government Service Affect Public Trust in Government? Evidence from China

8:30 a.m. - 9:45 a.m.

Rhode Island

Journal Editor Roundtable: The Challenges of Globalizing Public Administration Scholarship

Global Public Administration

Endorsed By:

Association for Budgeting and Financial Management, Section for Women in Public Administration, Section on Public Administration Education, Section on Public Administration Research and Students and New Administration Professionals Section

MODERATOR

Brian Cook

Professor, Virginia Tech

DISCUSSANT

Alasdair Roberts

Professor, University of Massachusetts—Amherst
Administrative Theory and Praxis

PRESENTERS

Jeremy Hall

Co-Editor in Chief, *Public Administration Review*, and Professor and MPA Director, University of Central Florida
Public Administration Review

Bruce McDonald

Associate Professor, North Carolina State University
Journal of Public Affairs Education

Lindsey McDougle

Associate Professor, Rutgers University—Newark
Journal of Public and Nonprofit Affairs

Janine O'Flynn

Professor, Australian and New Zealand School of Government
Australian Journal of Public Administration

Jessica Sowa

MPA Director and Associate Professor, University of Baltimore
Review of Public Personnel Administration

Staci Zavattaro

Associate Professor, University of Central Florida
Administrative Theory and Praxis

8:30 a.m. - 9:45 a.m.

Independence

NIGP Session—Creating Impact through Strategic Procurement

Public Finance

Endorsed By:

Section on Procurement and Contract Management

PRESENTERS

Rick Grimm

Chief Executive Officer, NIGP: The Institute for Public Procurement

Todd Slater

Chief Content Officer, NIGP: The Institute for Public Procurement

8:30 a.m. - 9:45 a.m.

Virginia

Best Practices in Public Ethics Management: The Role of Democratic Values

Public Service

Endorsed By:

Section on Democracy and Social Justice and Section on Ethics and Integrity in Governance

MODERATOR/PRESENTER

Frank Anechiarico

Maynard-Knox Professor of Government and Law, Hamilton College
Toward a Democratic Ethics Management Strategy

PRESENTERS

Staffan Andersson

Associate Professor, Linnaeus University
Measuring the Success of Ethics Management

Leo Huberts

Professor, Vrije Universiteit Amsterdam
Models of Ethics Management

Stefan Perun

Assistant Professor, Villanova University
“Why? Why? Why?” Is the Question of the Course”: MPA Students’ Perspectives on Their Learning in a Stand-Alone Ethics Course

Panels *(continued)*

Lydia Segal

Associate Professor, Suffolk University
Ethics Management in the Private Sector: Stewardship and Other Lessons

8:30 a.m. - 9:45 a.m.

Constitution

Toward Implementing Ethics: Values, Oaths, Codes and Laws

Public Service

Endorsed By:

Section for Women in Public Administration, Section on Democracy and Social Justice and Section on Ethics and Integrity in Governance

MODERATOR/COAUTHOR

Jonathan West

Professor and Chair, University of Miami
Assessing Oaths of Office: Documentary and Attitudinal Data

DISCUSSANT

Terry Murphy

Contract Oversight Specialist, Miami-Dade Office of the Inspector General

PRESENTERS/COAUTHORS

James Bowman

Professor, Florida State University
Assessing Oaths of Office: Documentary and Attitudinal Data

Rashmi Chordiya

Assistant Professor, Seattle University
The Impact of Values on Ethical Behaviors of Public Servants

Patrick Exmeyer

Assistant Professor, University of Louisiana—Monroe
Following the Leader: Exploring Trends in State Whistleblowing Laws Following Passage of the Whistleblowing Protection Enhancement Act of 2012

Meghna Sabharwal

Associate Professor, University of Texas at Dallas
The Impact of Values on Ethical Behaviors of Public Servants

James Svava

Visiting Scholar, University of North Carolina—Chapel Hill
Incorporating the ASPA Code of Ethics across the Curriculum

COAUTHORS

So Hee Jeon

Assistant Professor, Central Michigan University
Following the Leader: Exploring Trends in State Whistleblowing Laws Following Passage of the Whistleblowing Protection Enhancement Act of 2012

Charlene M. L. Roach

Lecturer, University of the West Indies
The Impact of Values on Ethical Behaviors of Public Servants

8:30 a.m. - 9:45 a.m.

Senate

Personnel Administration and Organizational Behavior

Public Service

Endorsed By:

Section for Women in Public Administration, Section on Ethics and Integrity in Governance and Section on Public Administration Research

PRESENTER

Hyunkang Hur

Assistant Professor, Indiana University—Kokomo
Job Insecurity and Its Effect on Organizational Performance: Does Senior Executive Services Accountability Make a Difference?

PRESENTERS/COAUTHORS

Evan Berman

Professor, Victoria University of Wellington
The Impact of Client Verbal Abuse in the Workplace: The Moderating Effect of Contextual Factors

Alexander Henderson

Associate Professor, Long Island University
Strengthening the Ties That Bind: Fostering Group Cohesiveness in Volunteer Fire Services

Ning Kang

Doctoral Student, University of Manchester
Emotional Labor and Employee Performance: A Systematic Literature Review

Panels (continued)

Geoff Plimmer

Director and Senior Lecturer, Victoria University of Wellington
The Impact of Client Verbal Abuse in the Workplace: The Moderating Effect of Contextual Factors

Thomas Poulin

Core Faculty, Capella University
Workplace Bullying in the Public Sector

Robert Wright

Core Faculty, Capella University
Workplace Bullying in the Public Sector

COAUTHORS

Imane Hijal-Moghrabi

Assistant Professor, University of Texas at Permian Basin
The Impact of Client Verbal Abuse in the Workplace: The Moderating Effect of Contextual Factors

Farhad Hossain

Researcher, University of Manchester
Emotional Labor and Employee Performance: A Systematic Literature Review

Yuguo Liao

Assistant Professor, University of Missouri—St. Louis
Integrating, Contending, Yielding or Avoiding? A Survey Experiment on City Managers' Choice of Conflict Management Strategies

Aminu Mamman

Reader, University of Manchester
Emotional Labor and Employee Performance: A Systematic Literature Review

Shuyang Peng

Assistant Professor, University of New Mexico
Integrating, Contending, Yielding or Avoiding? A Survey Experiment on City Managers' Choice of Conflict Management Strategies

Meghna Sabharwal

Associate Professor, University of Texas at Dallas
The Impact of Client Verbal Abuse in the Workplace: The Moderating Effect of Contextual Factors

Jessica Sowa

MPA Director and Associate Professor, University of Baltimore
Strengthening the Ties That Bind: Fostering Group Cohesiveness in Volunteer Fire Services

Rusi Sun

Assistant Professor, University of Michigan—Dearborn
Integrating, Contending, Yielding or Avoiding? A Survey Experiment on City Managers' Choice of Conflict Management Strategies

Xi Xi

Doctoral Student, University of Manchester
Emotional Labor and Employee Performance: A Systematic Literature Review

8:30 a.m. - 9:45 a.m.

South Carolina

Leading Change in Social Equity through Planning, Research and Disseminating Information

Social Equity

Endorsed By:

Section for Women in Public Administration and Section on Democracy and Social Justice

MODERATOR

RaJade Berry-James

Associate Professor of Public Administration, North Carolina State University, School of Public and International Affairs

PRESENTERS

Margo Bailey

Senior Advisor for Strategic Management, Office of Science and Data Policy, U.S. Department of Health and Human Services
Social Equity and Stakeholder Engagement in the Strategic Planning Process

Rashida Dorsey

Director, Data Development and Information Products Division, U.S. Equal Employment Opportunity Commission
The Role of Federal Data in Measuring Equity

Deborah LeBlanc

Professor, National University
The Art of Public Service in Teaching Adult Leaders: Self-Reflections

Voris McBurnette

Director, Center for Applied Strategic Learning, National Defense University
Shared Democratic Values: An Important Element in Building Capacity

Panels *(continued)*

Charles E. Menifield

Dean, Rutgers University—Newark
Assessing the Impact of CHIP, 20 Years Later

8:30 a.m. - 9:45 a.m.

Maryland

Global Corruption and Ethics Management

Social Equity

Endorsed By:

Section for Women in Public Administration, Section on Democracy and Social Justice, Section on Effective and Sound Administration in the Middle East and Section on Ethics and Integrity in Governance

CONVENER

Carole Jurkiewicz

Professor, Ethics and Public Integrity, University of Colorado Colorado Springs and Affiliate and Principal, Jurkiewicz and Associates, LLC

DISCUSSANTS

Leo Huberts

Professor, Vrije Universiteit Amsterdam

Adam Masters

Professor, Australian National University

Anna Simonati

Associate Professor, University of Trento Faculty of Law

PRESENTERS

David Arellano-Gault

Professor, Centro de Investigación y Docencia Económicas
Comparative Analyses of Unethical Practices across Cultures: Reversing the Negative Social Aspects

Kathryn Denhardt

Executive Consultant, Denhardt Consulting LLC
Whistleblowing: Encouraging Responsible Reporting and Developing Effective Whistleblower Protections

Daniel Feldman

Professor, John Jay College of Criminal Justice, City University of New York
Corruption in Italy: Indigenous Impediments to Reform

Michael Macaulay

Associate Professor and Associate Dean, Victoria University
Learning from Each Other: What Can and Can't be Transferred in the Field of Anti-Corruption?

Roseanne Mirabella

Professor, Seton Hall University
The NGO Aid Sex Scandal and Rethinking Nonprofit Theory and Governance

8:30 a.m. - 9:45 a.m.

Pennsylvania

The Queering of a Nation

Social Equity

Endorsed By:

Section for Women in Public Administration, Section on Democracy and Social Justice, Section on Ethics and Integrity in Governance and Section on Public Law Administration

MODERATOR/DISCUSSANT

Richard Johnson

Professor and Program Director, University of San Francisco

PRESENTERS

Heron Greenesmith

Senior Research Analyst, Political Research Associates
From the White House to City Hall: Local, State and Federal Policy Advocacy for Bisexual and Pansexual Communities

Sean McCandless

Assistant Professor, University of Illinois—Springfield
Law Enforcement and LGBT Homeless Youth

Lorenda Naylor

Associate Professor and Director, University of Baltimore
Providing Solutions to LGBT Youth Homelessness: A Case Study of the Youth Empowerment Society in Baltimore City

Kris Norman-Major

Professor and Director, Public Administration Programs, Hamline University
The Intersection of Sectors in Addressing Homeless LGBT Youth

Paula Overby

Political Organizer
Transgender Community and Inherent Contradictions in Gender Related Public Policy

Christopher Surfus

Doctoral Student, Western Michigan University
Challenges and Opportunities for the LGBTQ Community at the State and Local Levels

Panels *(continued)*

8:30 a.m. - 9:45 a.m. North Carolina

Equity in Action: Advancing Leadership for Communities of Color

Social Equity

Endorsed By:

Section for Women in Public Administration, Section on Democracy and Social Justice, Section on Ethics and Integrity in Governance and Section on Public Administration Research

MODERATOR

Brittany Keegan

Doctoral Student, Virginia Commonwealth University

PRESENTERS

Saman Aghaebrahim

Special Assistant, Office of the Governor, Commonwealth of Virginia

Vanessa Walker Harris

Director, Office of Family Health Services, Virginia Department of Health
Race and Redistricting

PRESENTERS/COAUTHORS

Taryn Anthony

Internal Policies and Procedures Specialist, Delta Sigma Theta Sorority Inc.

Assessing the Racial Equity Impact of Legislation to Establish a Virginia Grocery Investment Program and Fund

Nakeina Douglas-Glenn

Director, Grace E. Harris Leadership Institute, Virginia Commonwealth University

Building Leadership Capacity for Racial Equity: The Minority Political Leadership Institute

Shabana Shaheen

Research Coordinator, Grace E. Harris Leadership Institute, Virginia Commonwealth University
Building Leadership Capacity for Racial Equity: The Minority Political Leadership Institute

Exhibit Hall Open

9:00 a.m. - 7:00 p.m. State and East Rooms

Elliot Richardson Lecture

10:00 a.m. - 11:30 a.m. Grand Ballroom

Sponsored By:

Ohio State University, John Glenn College School of Public Affairs

LECTURER

Jack Knott

Dean, Sol Price School of Public Policy, University of Southern California

PRESENTERS

Paul C. Light

Paulette Goddard Professor of Public Service, New York University

Shelley Metzenbaum

Founder, The BETTER Project

MASTER OF CEREMONIES

J. Paul Blake

District IV Representative, ASPA National Council

Gloria Hobson Nordin Social Equity Luncheon

11:45 a.m. - 1:00 p.m. District Ballroom

(Ticketed Event)

SPEAKER

Brandi Blessett

Associate Professor, University of Cincinnati

MASTER OF CEREMONIES

J. Paul Blake

District IV Representative, ASPA National Council

Presidential Panel

11:45 a.m. - 1:00 p.m. Chinese Ballroom

No Time to Wait

Public Service

MODERATOR

Thelma Hite-Harris

Project Director, National Academy of Public Administration

PRESENTERS

Anita Blair

Fellow, National Academy of Public Administration

Maggie Mello

Associate Director, Volcker Alliance

Peter Warren

Associate Director, U.S. Office of Management and Budget

Panels

11:45 a.m. - 1:00 p.m. New York

Social Equity: Approaches and Considerations in the Asia Pacific Region

Social Equity

Endorsed By:

Section on Chinese Public Administration, Section on Democracy and Social Justice and Section on Ethics and Integrity in Governance

MODERATOR/DISCUSSANT

Morgen Johansen

Professor, University of Hawaii—Manoa

DISCUSSANT/PRESENTER

Yvonne Haigh

Academic Chair and Professor, Murdoch University
Social Equity: Approaches and Considerations in the Asia Pacific Region

DISCUSSANT/COAUTHOR

Sara Mattingly-Jordan

Professor, Virginia Tech
Social Equity in Hong Kong

PRESENTERS

Alex Brillantes, Jr.

Professor, University of the Philippines
Social Equity in the Philippines: A Continuing but Elusive Promise

Mathew Mathews

Senior Research Fellow, Lee Kuan Yew School of Public Policy, National University of Singapore
Social Equity in Singapore

PRESENTERS/COAUTHORS

Hui Zhou

Doctoral Student, University of Houston
“Two Chinas”: Social Equity, Social Policies and the Urban-Rural Divide in China

Ling Zhu

Associate Professor, University of Houston
“Two Chinas”: Social Equity, Social Policies and the Urban-Rural Divide in China

COAUTHOR

Kim Moloney

Senior Lecturer, Murdoch University
Social Equity in Australia and the United States: Reconceptualizing the Mythical Ideal

11:45 a.m. - 1:00 p.m.

Virginia

Perspectives and Approaches for Promoting LGBTQ Equity

Social Equity

Endorsed By:

Section on Democracy and Social Justice and Section on Ethics and Integrity in Governance

MODERATOR/PRESENTER

Wallace Swan

Contributing Faculty Member, Walden University
The Routledge Handbook of LGBTQIA Administration and Policy (2019)

PRESENTERS

Roddrick Colvin

Associate Professor, San Diego State University
Nonbinary Gender Policies: Understanding How Agencies Adopt and Resistance to Change

Tane Danger

Co-Founder, The Theater of Public Policy, Gustavus Adolphus College
Using Interactive Quiz Shows to Promote Civil Dialogue and Civic Engagement on LGBT Issues

Michael Grewe

Director of LGBTQIA+ Student Services, Augsburg University
Promoting LGBTQIA+ Equity in Higher Education

Panels *(continued)*

Jennifer Hooker

Doctoral Student and Lecturer, University of Colorado Denver

The Importance of Contact: Understanding Bureaucratic LGBTQ Advocacy

11:45 a.m. - 1:00 p.m.

Maryland

Examining the Structures that Make or Break Equitable Decisionmaking

Social Equity

Endorsed By:

Section for Women in Public Administration, Section on Democracy and Social Justice, Section on Ethics and Integrity in Governance and Section on Health and Human Services Administration

PRESENTERS

Stephanie Hawke

Research Associate, Oakland Housing Authority
Modeling Gentrification, Making Policy: Deploying a New Model of Displacement in Oakland Housing Authority

Katherine Hoffman

Cannabis Policy and Rules Coordinator, Washington State Liquor and Cannabis Board and Doctoral Student, Antioch University Midwest
Substantially Similar: Exploring the Effect of Opioid Prescribing Legislation in Washington State through a Complexity Lens

Kaila Williams

Doctoral Student, Florida International University
The Hidden Agenda of Tie Formation in Opioid Task Force Meetings

PRESENTERS/COAUTHORS

Tony Carrizales

Associate Professor, Marist College
Advancing Technology through Cultural Competence: How Government Websites Respond to Diversity

Celeste Greene

Associate Professor and Program Director, University of Virginia
Communal Resiliency and Environmental Justice: Examining the Aftermath of the Deepwater Horizon Oil Spill

Youngwoong Kang

Research Fellow, Seoul National University
Can Public Service Delivery Be Oriented Toward Community Well-Being beyond Meeting Basic Needs?

Seung Jong Lee

Professor and Dean, Seoul National University
Can Public Service Delivery Be Oriented Toward Community Well-Being beyond Meeting Basic Needs?

Tonya Neaves

Director, Centers on the Public Service, George Mason University
Communal Resiliency and Environmental Justice: Examining the Aftermath of the Deepwater Horizon Oil Spill

COAUTHOR

James Melitski

Professor, Marist College
Advancing Technology through Cultural Competence: How Government Websites Respond to Diversity

11:45 a.m. - 1:00 p.m.

Independence

Mexico and the United States: Domestic Concerns and International Relations

Global Public Administration

Endorsed By:

International Chapter

MODERATOR/PRESENTER

Donald Klingner

Distinguished Professor, University of Colorado Colorado Springs
Ideology, Public Policy and Public Management Practice: This Border-Crosser's 25-Year Retrospective on Relations Between the United States and Mexico

PRESENTERS

Mauricio Covarrubias

General Secretary, Universidad del Desarrollo
Empresarial y Pedagógico
Interdependence and Coordination in the Bilateral Mexico-United States Agenda: The Arms Trafficking Problem

Roberto Moreno Espinosa

Profesor-Investigador, Universidad Autónoma del Estado de México, Amecameca Campus
Mexico and the United States in a New Era: The Dawn of Morena

Panels *(continued)*

PRESENTERS/COAUTHORS

Jason Ackleson

Adjunct Associate Professor, Kansas State University
The United States-Mexico Borderlands: Exploring Alternative Futures

Guadalupe Correa-Cabrera

Associate Professor, George Mason University
The United States-Mexico Borderlands: Exploring Alternative Futures

COAUTHOR

Juan Pablo Aguirre Quezada

Researcher and Postdoctoral Fellow, Alcalá University, Spain, Senate, Republic of Mexico
Interdependence and Coordination in the Bilateral Mexico-United States Agenda: The Arms Trafficking Problem

11:45 a.m. - 1:00 p.m.

Suite 230

Environmental Policy and Management: Private Sector Entrepreneurship and Citizen Engagement

Global Public Administration

Endorsed By:

Section on Chinese Public Administration and Section on Environmental and Natural Resources Administration

MODERATOR/PRESENTER

John McCaskill

Clinical Professor, University of Texas at Dallas
How Regional Institutional Logics Influence the Adoption of Initiatives Such as Conscious Capitalism

PRESENTERS

Xinli Hu

Associate Professor, South Central University for Nationalities
Public Participation in Governmental Environmental Protection Online and Offline: A Case Study from 1995-2018

Shijun Li

Doctoral Student, Huazhong University of Science and Technology
Citizen Participation in Wildlife Management: A Case Study of "Retaining the Smile of the Yangtze River" Project

PRESENTERS/COAUTHORS

Holly Hull Miori

Student, University of Texas at Dallas
How Regional Institutional Logics Influence the Adoption of Initiatives Such as Conscious Capitalism

Meng Yuan

Doctoral Student, Northern Illinois University
Environmental Concern Among Chinese Youth: The Role of Knowledge and Cultures

COAUTHORS

James Harrington

Assistant Professor, University of Texas at Dallas
How Regional Institutional Logics Influence the Adoption of Initiatives Such as Conscious Capitalism

Jingjing Zeng

Associate Professor, Zhongnan University of Economics and Law
Environmental Concern Among Chinese Youth: The Role of Knowledge and Cultures

11:45 a.m. - 1:00 p.m.

Rhode Island

Exploring Similarities and Differences through the PV-GPG Framework: Assessing 40 Years of Performance Reform Between China and the United States

Global Public Administration

Endorsed By:

Section on Chinese Public Administration, Section on Public Administration Research and Section on Public Performance and Management

MODERATOR

Kuotsai Liou

Professor, University of Central Florida

DISCUSSANTS

Stephen Condrey

President, Condrey and Associates Inc.

David Rosenbloom

Distinguished Professor, American University and Chinese Thousand Talents Program Professor, Renmin University of China

Kaifeng Yang

Dean and Professor, School of Public Administration and Policy, Renmin University of China

Panels *(continued)*

PRESENTERS

Xuejiao Niu

Associate Professor, Lanzhou University
Unwilling or Unable? Encouraging Public Sector Environmental Leadership Behavior: Evidence from Local Governments in China

Hong Zhang

Doctoral Student, Lanzhou University
Exploring the Tensions Between Mission and Nonmission-Based Values in the Process of Performance Leadership

PRESENTERS/COAUTHORS

Irving Huang

Associate Professor, Tamkang University
From Individual to Strategic Performance Management: A Comparative Analysis Between the United States and China

Xiang Ma

Doctoral Student, Lanzhou University
Research on Methodology of Public Project Performance Loss Governance Based on PV-GPG Theory: Taking the World Bank Public Project as a Case

Xuejun Wang

Associate Dean and Associate Professor, Lanzhou University
Beyond the Dualism of Efficiency-or-Justice: Public Servants' Public Values Preferences Structure and Measurement

Guoxing Zhang

Professor, Lanzhou University
Differences and Similarities of Environmental Performance Governance Evolution Between China and the United States from the Perspective of PV-GPG Theory

COAUTHORS

Guoxian Bao

Honorary Dean and Professor, Lanzhou University
Research on Methodology of Public Project Performance Loss Governance Based on PV-GPG Theory: Taking the World Bank Public Project as a Case

Haixu Bao

Lecturer, Lanzhou University
Differences and Similarities of Environmental Performance Governance Evolution Between China and the United States from the Perspective of PV-GPG Theory

Mei Lang

Associate Professor, Lanzhou University
From Individual to Strategic Performance Management: A Comparative Analysis Between the United States and China

Ziqi Wang

MPA Student, Lanzhou University
Beyond the Dualism of Efficiency-or-Justice: Public Servants' Public Values Preferences Structure and Measurement

11:45 a.m. - 1:00 p.m.

New Hampshire

The Future of Financing Infrastructure, Creating Jobs and Boosting Economic Development

Infrastructure

Endorsed By:

Association for Budgeting and Financial Management, Section on Public Administration Research and Section on Transportation Policy and Administration

MODERATOR/PRESENTER

Can Chen

Assistant Professor, Florida International University
Innovative Practices in Local Infrastructure Finance: A Mixed-Method Approach

DISCUSSANT/PRESENTER

John Bartle

Dean and Professor, University of Nebraska—Omaha
Innovative Practices in Local Infrastructure Finance: A Mixed-Method Approach

PRESENTERS

Chad Miller

Professor, University of Southern Mississippi
Leveraging Defense Infrastructure for Economic Development

J. Allen Staley

Fiscal Director and Doctoral Student, State of Tennessee and Tennessee State University
Advocating for Transit Infrastructure: A 10-City Investigation of How Advocacy Networks Impact Infrastructure Development and Policy

Xiaoheng Wang

Doctoral Student, University of Illinois—Chicago
Determinants of Infrastructure Investment in American Local Governments: The Case of Florida Counties

Panels *(continued)*

11:45 a.m. - 1:00 p.m.

Senate

Community Resiliency after Multiple Billion-Dollar Disasters in the United States and Abroad

Infrastructure

Endorsed By:

Section for Women in Public Administration, Section on Complexity and Network Studies, Section on Emergency and Crisis Management and Section on Environmental and Natural Resources Administration

MODERATOR/PRESENTER

Claire Knox

Associate Professor and EMHS Program Director,
University of Central Florida

Resiliency after Hurricane Irma: Analysis of After-Action Reports

DISCUSSANT

John Kiefer

Professor, University of New Orleans

PRESENTERS

Christopher Emrich

Associate Professor, University of Central Florida
Defining and Measuring Community Disaster Resilience

Alessandra Jerolleman

Assistant Professor, Jacksonville State University
The Challenges of Post-Disaster Recovery in Rural Areas

PRESENTERS/COAUTHORS

Juan Lugo

Graduate Student, University of Central Florida
Resiliency after Hurricane Irma: Analysis of After-Action Reports

Wen-Jiun Wang

Assistant Professor, Sam Houston State University
Exploring Typhoon Resilience in Taiwan: An Investigation of "Typhoon Day-Off" Decisionmaking

11:45 a.m. - 1:00 p.m.

North Carolina

Crisis and Disaster Management and Risk Communication

Infrastructure

Endorsed By:

Section on Chinese Public Administration, Section on Emergency and Crisis Management and Section on Environmental and Natural Resources Administration

PRESENTERS

Kaiju Chang

Associate Professor, National Chengchi University
The Roles of Public Educators for Developing Disaster Resilient Communities: A Knowledge Brokering Perspective

William Pelfrey

Chair, Homeland Security and Emergency Preparedness,
Virginia Commonwealth University
Mass Notification Systems: A Preliminary Assessment of System Efficacy Relative to Jurisdiction Demographics

Qiaoyun Yang

Lecturer, Dalian University of Technology
Rapid Responsive Intelligence System in Emergency Decisionmaking for Major Disasters

PRESENTER/COAUTHOR

Yuming Wei

Student, Tsinghua University
Suppression or Concession: The Strategies of Local Governments in Response to Public Opposition to Nuclear Projects in China

COAUTHOR

Yue Guo

Assistant Professor, Beijing Normal University
Suppression or Concession: The Strategies of Local Governments in Response to Public Opposition to Nuclear Projects in China

Panels *(continued)*

11:45 a.m. - 1:00 p.m.

South Carolina

Infrastructure Management and Policies: Theoretical Frameworks, Research and Real- World Applications

Infrastructure

Endorsed By:

Section on Complexity and Network Studies and Section on Emergency and Crisis Management

MODERATOR/PRESENTER

Dohyeong Kim

Associate Professor, University of Texas at Dallas
Using Causal Loop to Evaluate Safety Against Crime in Sustainable Urban Metabolism Framework

PRESENTERS

Nittam Chandel

Associate Professor, Swami Vivekanand Government College Ghumarwin
The Role of Technology in Inclusive Growth and Societal Transformation in India: A Study of Digital India Programme

Peter Federman

Doctoral Student, University of Kansas
Cities in Crisis: How the Bureaucratic Politics of Public Health and Safety Shape the American Experience

Asim Zia

Professor, University of Vermont
Socio-Psychological Determinants of Cattle Producers' Intent to Comply with Animal Disease Control Regulations

PRESENTERS/COAUTHORS

Ki Woong Cho

Research Professor and Postdoctoral Researcher, Korea University
Illuminating the Sewol Ferry Disaster Using the Institutional Model of Punctuated Equilibrium Theory

Qian Hu

Associate Professor, University of Central Florida
Emergency and Crisis Management Network Research: Theory to Practice

Kyujin Jung

Assistant Professor, SungKyunKwan University
Illuminating the Sewol Ferry Disaster Using the Institutional Model of Punctuated Equilibrium Theory

COAUTHORS

Naim Kapucu

Professor and Director, University of Central Florida
Emergency and Crisis Management Network Research: Theory to Practice

Jungwon Yeo

Assistant Professor, University of Central Florida
Emergency and Crisis Management Network Research: Theory to Practice

11:45 a.m. - 1:00 p.m.

Pennsylvania

Nuts and Bolts for Managers

Public Service

PRESENTERS

Alice Feldesman

Assistant Director, U.S. Government Accountability Office
Surveys: Finding the Message in the Tables

Montgomery Van Wart

Professor, California State University—San Bernardino
The Strategic Use of Media in Organizations: A Leadership Perspective

PRESENTERS/COAUTHORS

Kevin Campbell

Doctoral Student, University of Kansas
Simmering on the Back Burner: The Role of Job Analysis in Employment Litigation

Samuel Gallaher

Data Analytics and Methodology Specialist, City and County of Denver
Academic Research as Audit Criteria: Roadblocks on the Path of Incorporating Research into the Audit Function

Robert Persichitte

Senior Auditor, Office of the Auditor, City and County of Denver
Academic Research as Audit Criteria: Roadblocks on the Path of Incorporating Research into the Audit Function

COAUTHOR

Heather Getha-Taylor

Associate Professor, University of Kansas
Simmering on the Back Burner: The Role of Job Analysis in Employment Litigation

Panels *(continued)*

11:45 a.m. - 1:00 p.m.

New Jersey

Key Challenges in Conducting Performance Management

Public Service

Endorsed By:

Association for Budgeting and Financial Management, Section on Democracy and Social Justice, Section on Public Administration Research and Section on Public Performance and Management

MODERATOR

Richard Greene

Principal, Barrett and Greene, Inc.

DISCUSSANT/COAUTHOR

Katherine Barrett

Principal, Barrett and Greene, Inc.

PRESENTERS

Philip Joyce

Senior Associate Dean and Professor, University of Maryland

Case Studies of Performance Management Challenges and How They Were Addressed

John Kamensky

Senior Fellow, The IBM Center for The Business of Government

Examples of Performance Challenges in the U.S. Federal Government and How They Were Addressed

Shelley Metzenbaum

Founder, The BETTER Project

Examples of Performance Management Challenges from Experience at OMB and How They Were Addressed

Rakesh Mohan

Director, Office of Performance Evaluations, Idaho State Legislature

Specific Examples of Performance Management Challenges at the State Level

Donald Moynihan

Associate Director, LaFollette School of Public Affairs, University of Wisconsin—Madison

Case Studies of Performance Management Challenges and How They Were Addressed

Public Service Plenary

1:30 p.m. - 3:00 p.m.

Grand Ballroom

PANELISTS

Mary Guy

Professor, University of Colorado Denver

Patricia Shields

Professor, Texas State University

MASTER OF CEREMONIES

J. Paul Blake

District IV Representative, ASPA National Council

Presidential Panel

3:15 p.m. - 4:30 p.m.

Chinese Ballroom

University Nervous Areas of Government: Monuments and Reparations

Social Equity

MODERATOR

Susan T. Gooden

Interim Dean, L. Douglas Wilder School, Virginia Commonwealth University

PRESENTERS

Curtis Brown

Chief Deputy State Coordinator, Virginia Department of Emergency Management and Former Deputy Secretary of Public Safety and Homeland Security Commonwealth of Virginia

Hannah Cameron

Co-Chair, History and Civil Rights Working Committee, Virginia Commonwealth University

John Stephens

Associate Professor of Public Administration and Government, University of North Carolina

Founders' Fellows Panel

3:15 p.m. - 4:30 p.m. Virginia

Improving Service Delivery in Public Sector Organizations in the U.S. and Abroad

MODERATOR/PRESENTER

Pooja Paswan

Assistant Professor, Jamia Millia Islamia
Challenges of Low-Income Democracies in Public Service Delivery

PRESENTERS

Victoria Martin-Nammour

MPA Student, University of Central Florida
Solutions to Issues Affecting the Public Administration Landscape Today

Assel Mussagulova

Doctoral Student, Nanyang Technological University, Singapore
Twenty-Eight Years Later: A Cross-Country Analysis of Development Divergence and Bureaucratic Institutions in Post-Communist States

Amy Owen

Doctoral Student, Tennessee State University
Role Theory in Public Education Governance

Shahrin Upoma

Doctoral Student, University of Texas at Dallas
Do Civil Service Reforms Increase the Accountability of Public Service Personnel and Organizations? A Comparative Analysis

Panels

3:15 p.m. - 4:30 p.m. Pennsylvania

IIAS Panel—Trends in Public Administration Teaching and Accreditation

Global Public Administration

Endorsed By:

Section on Public Administration Education, Section on Public Administration Research and Students and New Administration Professionals Section

MODERATOR/DISCUSSANT

Geert Bouckaert

Professor and IIAS President, KU Leuven Public Governance Institute

DISCUSSANT

Allan Rosenbaum

Professor, Public Administration and Director, Institute for Public Management and Center for Democracy and Good Governance, Florida International University

PRESENTER

Kaifeng Yang

Dean and Professor, School of Public Administration and Policy, Renmin University of China
Lessons of Ongoing Accreditation Rounds in China

3:15 p.m. - 4:30 p.m. Maryland

Urban Governance in Transitional China

Global Public Administration

Endorsed By:

Association for Budgeting and Financial Management, International Chapter and Section on Chinese Public Administration

MODERATOR

Weiwen Zhang

Professor and Deputy Dean, Zhejiang University

DISCUSSANT/PRESENTER

Junli Yu

Assistant Professor, Shanghai Jiaotong University
Economic Growth, Air Pollution and Urban Governance: Evidence from China

DISCUSSANT/COAUTHOR

Cathy Yang Liu

Associate Professor, Georgia State University
Migrants' Social Integration and Local Governance in China's Small-Town Urbanization: A Case from Zhejiang Province

PRESENTER

Hongchuan Wang

Postdoctorate, Tsinghua University
Hybridity and Accountability: A Comparative Study of Shared Ownership Housing in London and Beijing

PRESENTERS/COAUTHORS

Xinyu Dong

Associate Professor, Xi'an Jiaotong University
Do Citizens Trust Urban Management Enforcement? An Empirical Study of Xi'an City

Panels *(continued)*

Hejia Zhuo

Student, Zhejiang University
Migrants' Social Integration and Local Governance in China's Small-Town Urbanization: A Case from Zhejiang Province

COAUTHORS

Libo Yang

Doctoral Student, Xi'an Jiaotong University
Do Citizens Trust Urban Management Enforcement? An Empirical Study of Xi'an City

Zhirong Zhao

Associate Professor, University of Minnesota
Migrants' Social Integration and Local Governance in China's Small-Town Urbanization: A Case from Zhejiang Province

3:15 p.m. - 4:30 p.m.

Rhode Island

Co-Producing Better Policy Outcomes in China: Open Data, Green Energy and Bike-Sharing

Infrastructure

Endorsed By:

Section on Chinese Public Administration, Section on Environmental and Natural Resources Administration, Section on Public Administration Research and Section on Science and Technology in Government

MODERATOR/ PRESENTER/COAUTHOR

Bingsheng Liu

Professor, Tianjin University
How Do Compensation Expectations Influence Policy Acceptance? Evidence from China and Compensation Expectation, Social Equality and Public Acceptance in Policies

DISCUSSANT

Huafang Li

Assistant Professor, Grand Valley State University

PRESENTER

Liya Di

Yanshan University
Studies on Cognitive Level Survey on Open Government Data of Government Staff in China

PRESENTERS/COAUTHORS

Liping Fu

Professor, Tianjin University
How Bike Sharing Challenges Public Policy in China: Balancing Public Needs and the Cost of City Management

Lanping He

Associate Professor, Tianjin University
How Bike Sharing Challenges Public Policy in China: Balancing Public Needs and the Cost of City Management

Ling Li

Professor, Tianjin University
Compensation Expectation, Social Equality and Public Acceptance in Policies

Tao Teng

Doctoral Student, Tianjin University
How Bike Sharing Challenges Public Policy in China: Balancing Public Needs and the Cost of City Management

Liangfu Wu

Professor, Tianjin University
How Bike Sharing Challenges Public Policy in China: Balancing Public Needs and the Cost of City Management

Jingjing Xiao

Master Student, Tianjin University
How Do Compensation Expectations Influence Policy Acceptance? Evidence from China

Yu Zhai

Tianjin University
Compensation Expectation, Social Equality and Public Acceptance in Policies

Panels *(continued)*

3:15 p.m. - 4:30 p.m.

North Carolina

Negotiating Successful Environmental Planning and Management

Infrastructure

Endorsed By:

Association for Budgeting and Financial Management, Section for Women in Public Administration, Section on Environmental and Natural Resources Administration and Section on Ethics and Integrity in Governance

MODERATOR/COAUTHOR

Christopher Galik

Associate Professor, North Carolina State University
Revisiting Institutional Stability in the Face of Attempted Change: The Case of U.S. Air Policy

PRESENTER

Megan DeMasters

Assistant Coordinator, Environmental Services, City of Fort Collins
A Tale of Two Programs: Comparing the Policy Process for Outdoor Residential Burning and Radon

PRESENTERS/COAUTHORS

Luke Fowler

Assistant Professor and MPA Director, Boise State University
Moral Hazards and Competing Incentives for Intergovernmental Environmental Management

Ki Eun Kang

Doctoral Student, Binghamton University, The State University of New York
What Drives Environmental Planning? Results from a Survey of New York State Officials

Qingduo Mao

Doctoral Student, Shandong University
Performance Ranking, Government Behavior and Environmental Governance: A Study of Air Pollution Based on Agent-Based Modeling

Pragati Rawat

Assistant Professor, Slippery Rock University
Environmental Management Decisionmaking: Biased or Not? A Case of Tidal Wetlands Boards in Virginia Counties

Leila Vaughan

Doctoral Student, North Carolina State University
Revisiting Institutional Stability in the Face of Attempted Change: The Case of U.S. Air Policy

COAUTHORS

Michelle Covi

Assistant Professor, Old Dominion University
Environmental Management Decisionmaking—Biased or Not? A Case of Tidal Wetlands Boards in Virginia Counties

Elizabeth Fredericksen

Professor, Boise State University
Moral Hazards and Competing Incentives for Intergovernmental Environmental Management

George Homsy

Assistant Professor, Binghamton University, The State University of New York
What Drives Environmental Planning? Results from a Survey of New York State Officials

Ben Ma

Professor, Shandong University
Performance Ranking, Government Behavior and Environmental Governance: A Study of Air Pollution Based On Agent-Based Modeling

Wie Yusuf

Associate Professor, Old Dominion University
Environmental Management Decisionmaking—Biased or Not? A Case of Tidal Wetlands Boards in Virginia Counties

3:15 p.m. - 4:30 p.m.

Constitution

The Urgency of Now: Diversity and Inclusion in Emergency Management

Infrastructure

Endorsed By:

Section on Democracy and Social Justice, Section on Emergency and Crisis Management and Section on Ethics and Integrity in Governance

CONVENER

Tonya Neaves

Director, Centers on the Public Service, George Mason University

Panels *(continued)*

MODERATOR

Curtis Brown

Deputy Coordinator, Virginia Department of Emergency Management

PRESENTERS

Walter English

Deputy Emergency Manager, City of Fairfax, Virginia

Andrew Williams

Chief Operating Officer, The Berkley Group LLC

Brian D. Williams

Assistant Professor, Lamar University
Public Values, Research and Practice: An Investigation of the Knowledge Gap through Social Vulnerability

Chauncia Willis

Emergency Manager, City of Tampa, Florida

3:15 p.m. - 4:30 p.m.

South Carolina

Accountability and Performance Management in Public Management and Collaborative Governance Networks

Infrastructure

Endorsed By:

Section on Complexity and Network Studies, Section on Democracy and Social Justice, Section on Public Administration Research and Section on Public Performance and Management

MODERATOR/PRESENTER

Aleksey Kolpakov

Assistant Professor, University of Nevada—Reno
Dynamic Model of Assessing Collaborative Performance
Process of Recidivism Reduction Networks Using Collaborative Governance Regime Model

MODERATOR/COAUTHOR

Michael Siciliano

Assistant Professor, University of Illinois—Chicago
Government as Network Catalyst: Preferential Attachment in the High-Tech Sector

PRESENTER

David Dornisch

Senior Social Scientist, U.S. Government Accountability Office
Multi-Methods Assessment of Network Performance in Federal Water Assistance Programs on Native American Lands: Comparing Current and Prospective Collaboration Structures and Practices

PRESENTERS/COAUTHORS

Jennifer Lanterman

Assistant Professor, University of Nevada—Reno
Dynamic Model of Assessing Collaborative Performance
Process of Recidivism Reduction Networks Using Collaborative Governance Regime Model

Stephen Northam

Lecturer, University of North Georgia
Government as Network Catalyst: Preferential Attachment in the High-Tech Sector

Steve Scheinert

Research Assistant Professor, University of Central Florida
Hybridized Accountability Structure in Watershed Governance Networks in Lake Champlain Basin

Travis Whetsell

Assistant Professor, Florida International University
Government as Network Catalyst: Preferential Attachment in the High-Tech Sector

COAUTHORS

Christopher Koliba

Professor, University of Vermont
Hybridized Accountability Structure in Watershed Governance Networks in Lake Champlain Basin

Jungwon Yeo

Assistant Professor, University of Central Florida
Hybridized Accountability Structure in Watershed Governance Networks in Lake Champlain Basin

3:15 p.m. - 4:30 p.m.

New Hampshire

The Promises and Pitfalls of Technology in Infrastructure

Infrastructure

Endorsed By:

Section on Public Administration Research, Section on Science and Technology in Government and Section on Transportation Policy and Administration

MODERATOR/PRESENTER

Roy Heidelberg

Assistant Professor, Louisiana State University
Propaganda and Progress: Good Roads across America

PRESENTERS

Nicole DuPuis

Doctoral Student, Virginia Tech
Stories of the Sharing Economy

Panels *(continued)*

Adam Eckerd

Assistant Professor, Indiana University—Purdue University Indianapolis
Planning Transportation in a Time of Rapid Innovation and Change

David Landsbergen

Associate Professor, Ohio State University
Open Data as Public Infrastructure

Jared Llorens

Director and Associate Professor, Louisiana State University
Evaluating the Promise of Information Technology Adoption within the Framework of Traditional Public Management Systems

3:15 p.m. - 4:30 p.m.

Suite 230

Infrastructure Policies, Programs and Opportunity Structures

Infrastructure

Endorsed By:

Section for Women in Public Administration, Section on Emergency and Crisis Management, Section on Environmental and Natural Resources Administration and Section on Transportation Policy and Administration

PRESENTERS

Karla Drenner

Graduate Professor, Kaplan University
Water and Power: A Legislative Response to EPA's Coal Combustion Residual Rule

Amanda Goolden

Senior Analyst, U.S. Government Accountability Office
Lead in Drinking Water Infrastructure: Challenges and Next Steps

John Grathwol

Deputy Director, Budget Resources and Recovery Grant Management, New York City Mayor's Office of Management and Budget
Restoring Damaged Infrastructure after a Disaster: New York City Lessons from the Long-Term Hurricane Sandy Recovery

Catherine Horiuchi

Associate Professor, University of San Francisco
High Speed Rail: The Long Road to a Short Ride

Diane Raynes

Assistant Director, U.S. Government Accountability Office
Lead in Drinking Water Infrastructure: Challenges and Next Steps

Bethany Stich

Associate Professor, University of New Orleans
Using the Advocacy Coalition Framework to Understand Transportation Policy Change

3:15 p.m. - 4:30 p.m.

New Jersey

State Contributions to Disaster Response

Public Finance

Endorsed By:

Association for Budgeting and Financial Management, Section for Women in Public Administration and Section on Emergency and Crisis Management

MODERATOR

Ali Farazmand

Professor, Florida Atlantic University

MODERATOR/PRESENTER

Claire Knox

Associate Professor and EMHS Program Director, University of Central Florida
Florida Disaster Management Funding: Irma and Maria

DISCUSSANT

Richard Sylves

Professor Emeritus, University of Delaware

PRESENTERS

Frannie Edwards

Professor, San Jose State University
California Disaster Management Funding in the 2017 Napa and Sonoma Wildland Fires

John Kiefer

Professor, University of New Orleans
Louisiana Disaster Management Funding after Katrina

PRESENTERS/COAUTHORS

Colin Foard

Senior Associate, Government Performance, Fiscal Federalism Initiative, The Pew Charitable Trusts
State Participation in Funding Natural Disaster Management

David Mitchell

Assistant Professor, University of Central Florida
Florida Disaster Management Funding: Irma and Maria

Panels *(continued)*

COAUTHOR

Justin Theal

Officer, The Pew Charitable Trusts
State Participation in Funding Natural Disaster Management

3:15 p.m. - 4:30 p.m.

Senate

Dislodging Epistemic Injustice: Social Equity Imperatives

Social Equity

Endorsed By:

Section for Women in Public Administration, Section on Democracy and Social Justice and Section on Ethics and Integrity in Governance

MODERATOR/PRESENTER

Richard Johnson

Professor and Program Director, University of San Francisco
Epistemic Injustice and the Public Administration Classroom

PRESENTERS

James Foreman

MPA Student, University of Central Oklahoma
Confinement: How the Standard Story Denies Misaligned Conceptions of Structural Injustices for Juveniles

Jocelyn Gordon

MPA Student, University of Central Oklahoma
Housing: Acritical Givens Do not Foreclose Opportunities for Changing Conditions

G.L.A. Harris

Professor, Portland State University
Changing Language, Changing Culture: Toward Realizing Women's Full Agency in the U.S. Military

Katrina Norvell

Assistant Professor, Roger Williams University
Toward an Epistemology of Justice: Integrating the Six Rs into Public Administration Education

Elizabeth Overman

Professor, University of Central Oklahoma
Violence in the Reconfiguration of Social Worlds

Jennifer Swann

Administrative Coordinator, City of Oklahoma City
Moving the Needle in the Right-to-Food Discourse: Consumer Empowerment as the Realization of Substantive Justice

COAUTHOR

Joseph Fahrney

Command Master Chief, Naval Leadership and Ethics Center
Toward an Epistemology of Justice: Integrating the Six Rs into Public Administration Education

3:15 p.m. - 4:30 p.m.

New York

Governing Toward Social Equity

Social Equity

Endorsed By:

Section for Women in Public Administration, Section on Democracy and Social Justice and Section on Ethics and Integrity in Governance

MODERATOR

Nuri Heckler

Doctoral Student, University of Colorado Denver

DISCUSSANT

Brandi Blessett

Associate Professor, University of Cincinnati

PRESENTER

William Hatcher

Associate Professor, Augusta University
The Curious Public Administrator

PRESENTERS/COAUTHORS

Kirk Leach

Assistant Professor, University of Arkansas—Little Rock
Storytelling, Race and Community Development

Hannah Lebovits

Doctoral Student, Cleveland State University
Community Charter Reviews as a Vehicle for Social Change

Ashley Nickels

Assistant Professor, Kent State University
Community Charter Reviews as a Vehicle for Social Change

Panels *(continued)*

Gwendolyn Saffran

Student, John Jay College of Criminal Justice, City University of New York
Emergent Nonbinary Gender Identity Policy: Governing Toward Social Equity

COAUTHORS

Wesley Crichlow

Professor, University of Ontario Institute of Technology
Storytelling, Race and Community Development

Nicole Elias

Assistant Professor, John Jay College of Criminal Justice, City University of New York
Emergent Nonbinary Gender Identity Policy: Governing Toward Social Equity

3:15 p.m. - 4:30 p.m.

Independence

ARNOVA Session—Empowering Marginalized Groups' Democratic Activism

Social Equity

Endorsed By:

Section for Women in Public Administration, Section on Democracy and Social Justice, Section on Ethics and Integrity in Governance, Section on Public Administration Research and Students and New Administration Professionals Section

MODERATOR/COAUTHOR

Roseanne Mirabella

Professor, Seton Hall University
Critical Pedagogy and Nonprofit Management Education: Employing Counternarratives to Engage Students in Discussions of Advocacy and Social Change

PRESENTER

Lisa Dicke

Professor, University of North Texas
Creativity as Problem Solving: Valuing Resources at Hand

PRESENTERS/COAUTHORS

Khanh Nguyen

Operations and Programs Director, Vietnamese Youth Development Center, University of San Francisco
Critical Pedagogy and Nonprofit Management Education: Employing Counternarratives to Engage Students in Discussions of Advocacy and Social Change

Ashley Nickels

Assistant Professor, Kent State University
Participatory Philanthropy in Urban (Re)Development: Examining the Organizational Dynamics in a Collaborative Project to Enhance Community Development and Civic Participation

COAUTHORS

Michael D'Italia

Office of Civic Engagement, Rutgers University–Camden
Participatory Philanthropy in Urban (Re)Development: Examining the Organizational Dynamics in a Collaborative Project to Enhance Community Development and Civic Participation

Zachary Wood

Assistant Teaching Professor, Rutgers University–Camden
Participatory Philanthropy in Urban (Re)Development: Examining the Organizational Dynamics in a Collaborative Project to Enhance Community Development and Civic Participation

Global Public Administration Plenary and International Assembly

4:30 p.m. - 6:30 p.m.

Grand Ballroom

CONVENER

Allan Rosenbaum

Professor, Public Administration and Director, Institute for Public Management and Center for Democracy and Good Governance, Florida International University

LECTURER

Christopher Hill

U.S. Ambassador and Chief Advisor for Global Engagement and Professor of the Practice of Diplomacy, University of Denver

Exhibit Hall Reception

6:00 p.m. - 7:00 p.m. State and East Rooms

(Open to all attendees)

Sponsored By: **WILEY**

Networking Receptions

6:30 p.m. - 7:30 p.m. See Sunday Overview for Locations

(Open to all attendees)

Graduate School of Public and International Affairs, University of Pittsburgh Reception

University of Southern California Sol Price School of Public Policy Reception

Women in the Public Sector, the MPA PPA and MPA IO Programs and Department of Public Management at John Jay College Reception

EVERYTHING YOU NEED TO TRANSFORM BUDGETS IN YOUR CITY, STATE, OR ANY OTHER MISSION-DRIVEN ORGANIZATION

Join the author for a Pop-Up Book Talk on Saturday, March 9 at 5:00 p.m. in the Palm Court Ballroom

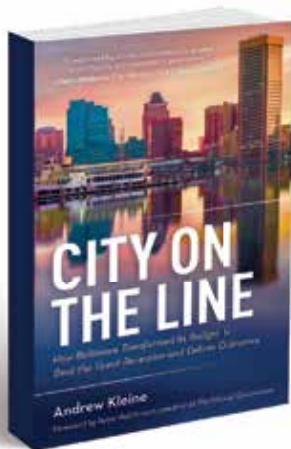

NEW

CITY ON THE LINE

How Baltimore Transformed Its Budget to Beat the Great Recession and Deliver Outcomes

By Andrew Kleine

"Andrew Kleine's book is a must read for all who are interested in greater accountability and innovation in government. Baltimore's journey is a fantastic example of both the challenges and successes of our complex landscape in local government." —*Darin Atteberry, city manager, Fort Collins, Colorado*

"In our work at Harvard on innovation in government we look for important expert contributions that will assist practitioners. *City on the Line* is one of the best and a call to action for leaders of every political stripe to think differently—very differently—about how tax dollars are spent." —*Stephen Goldsmith, former mayor of Indianapolis, and professor of government at the John F. Kennedy of Government at Harvard University*

Parts memoir, manifesto, and manual, this book tells the story of Baltimore's radical departure from traditional line item budgeting to a focus on outcomes like better schools, safer streets, and stronger neighborhoods—during one of the most tumultuous decades in the city's history.

Andrew Kleine is a nationally recognized leader in municipal finance and performance management. He served as Baltimore's budget director from 2008 to 2018.

October 2018 • 292 pages
978-1-5381-2188-7 • \$35.00 • Paper
978-1-5381-2189-4 • \$33.00 • eBook

www.cityontheline.com

ROWMAN &
LITTLEFIELD



Save 30% when you order these books with promo code **4S18CITY** on www.rowman.com or call 800-462-6420.



Research That Matters

The Schar School of Policy and Government at George Mason University brings together faculty who seek to push the frontiers of conventional wisdom, apply rigorous policy and administrative analysis to complex issues, and make connections to real-world decision makers and thought leaders in public service.

Located at the doorstep of the nation's capital, the Schar School prepares graduate and undergraduate students for careers in federal, state, and local government as well as private consulting firms and nonprofit organizations.

The Schar School is proud of our following accomplishments:

- Partner of Sandia National Labs on Frontiers in Resilience Symposium (2019)
- Home of ASPA's Conference Program Co-Chair (2018)
- Home of NAPA's Herbert Roback Scholarship Recipient (2018)
- Partner of NAPA on Prioritizing Governance for Resilient Critical Infrastructure Symposium (2017)
- Partner of the Washington Post on National Politics Polls
- Home of the Virginia Certified Public Manager® Program



SCHAR.GMU.EDU

Faculty members left to right: John Marvel, Tonya T. Neaves, Mark J. Rozell, and Jessica N. Terman

TRACKS

Global Public Administration

Infrastructure

Public Finance

Public Service

Social Equity

#ASPA2019

MONDAY SESSIONS

JUNE						
1	2	3	4	5	6	7
8	9	10	11	12	13	14
15	16	17	18	19	20	21
22	23	24	25	26	27	28
29	30	31				
AUGUST 1959						
1	2	3	4	5	6	7
8	9	10	11	12	13	14
15	16	17	18	19	20	21
22	23	24	25	26	27	28
29	30	31				

Training 'Pros' For Public Service

Pitt Graduate School Tackling Problems Of Cities And Nations

Courses Tailored To Fit Home Or Global Affairs

This is the age of the specialist. There is a premium on almost any kind of skill. Yet many towns, cities, even nations, are being run by comparative amateurs.

This is the first of three articles telling how the Graduate School of Public and International Affairs at the University of Pittsburgh is tackling the problem of making sure that administrators at all levels, both at home and abroad, know what they are doing.

All through the baking hot Arabian summer the buildings in the great oil company's fine new housing project multiplied and spread across the desert.

And the company's graduates, by their foresight. With modern, convenient houses like these, they wonder how could their Arab workers be anything but content? Why, they were just like American homes!

And that was just the trouble. No one had stopped to think that homes designed for Americans would be completely unsuited to Arabs.

The workers refused to live in them. A tremendous investment was wasted.

A thousand miles to the south, a party of Texan tourists sat comfortably in the cool lounge of Nairobi's Norfolk Hotel, where the barefoot, white-robed waiters were more than usually attentive.

Why They Got Service

If the visitors had stopped to wonder why they were

U. S. and the West. Or it can do just the opposite.

Christians Breed Hate

Irritations quickly become resentment. Resentments can soon turn into hatred. The salesmen of communism begin to appear highly attractive by comparison. Then it is merely a matter of time before "Yankee, Go Home!" appears in the streets.

Teaching Americans about the world in which they live—and how to behave when they are turned loose in it—is one of the vital jobs of a unique graduate school which opened last September at the University of Pittsburgh.

In its international programs at least, the Graduate School of Public and International Affairs is dedicated to the proposition that sauce for the goose is not necessarily sauce for the gander. That what goes around may be



GLENN W. FERGUSON
Dean and assistant dean study class schedules.

DONALD C. STONE

he said, "particularly in the international area.

"I had tried to persuade people of this for years, but with only modest success. I felt the inadequacy of existing academic programs in this field."

school. The two men spent more than a year planning the work of the school and signing about two dozen top-flight professors and lecturers to its faculty.

Budget expert, organization and methods authority and behind-the-scenes planner for many stages in the

Formerly president of Springfield College, Mass., he also has served as head of the Public Administration Service and has directed more than a hundred surveys and reorganizations of city, county, state and national agencies.

Join us at the GSPIA Reception

Sunday, March 10, 6:30 – 7:30 p.m.
The Mayflower Hotel, Senate Room

CONNECT with us:

@GSPIA

/pittgspia

@pittgspia

gspia.pitt.edu

Monday Sessions MARCH 11

TRACKS: ● Public Finance ● Infrastructure ● Social Equity ● Public Service ● Global PA

SESSION	TIME	Room
ASPA Registration Open	7:00 a.m. – 6:00 p.m.	Promenade Foyer
● SWPA National Awards Breakfast (<i>ticketed event</i>)	7:45 a.m. – 9:15 a.m.	District Ballroom
● Presidential Panel—Managing our Country’s Watershed Infrastructure (<i>Infrastructure Focus</i>)	8:00 a.m. – 9:15 a.m.	Chinese Ballroom
● Strategies for Successful Emergency Management Performance	8:00 a.m. – 9:15 a.m.	New Jersey
● Infrastructure in Motion: Transportation Issues	8:00 a.m. – 9:15 a.m.	Suite 230
● Governance in the Era of Internet Technology: Examples from China and South Korea	8:00 a.m. – 9:15 a.m.	Virginia
● Advancing Public Service through Collaborative Technologies	8:00 a.m. – 9:15 a.m.	Rhode Island
● Systematic Explanations of Corruption	8:00 a.m. – 9:15 a.m.	Senate
● Environmental Pollution, Political Trust and Governance	8:00 a.m. – 9:15 a.m.	South Carolina
● Emerging Urban and Regional Governance Issues in China	8:00 a.m. – 9:15 a.m.	New Hampshire
● AIRMAP Session—Advancing in French Public Services	8:00 a.m. – 9:15 a.m.	Maryland
● New Thinking on Public Service Values: Considering the Role of Emotions and Empathy in Public Service	8:00 a.m. – 9:15 a.m.	New York
● Why Research Matters: Promoting Social Equity in a Responsive System of Governance	8:00 a.m. – 9:15 a.m.	North Carolina
● Public Service for All: Toward Equitable Organizations and Policy	8:00 a.m. – 9:15 a.m.	Pennsylvania
● With an Ardent Focus on Equity: New Scholars’ Approaches to Fairness and Justice Research, Practice and Instruction	8:00 a.m. – 9:15 a.m.	Independence
● Local Immigrant Integration and Its Relationship to Today’s Polarized Immigration Policy Debate	8:00 a.m. – 9:15 a.m.	Massachusetts
Exhibit Hall	9:00 a.m. – 3:00 p.m.	State and East Rooms
Donald C. Stone Lecture	9:30 a.m. – 11:00 a.m.	Grand Ballroom
● Presidential Panel—#MeToo: The Role of Universities in the MeToo Movement (<i>Social Equity Focus</i>)	11:15 a.m. – 12:30 p.m.	Chinese Ballroom
Founders’ Fellows Panel: Public Human Resource Management Practices and Strategies	11:15 a.m. – 12:30 p.m.	Virginia
● SKPA Panel—Advancing Public Services Learned from the Korean Government Cases	11:15 a.m. – 12:30 p.m.	New York
● Multifaceted Governance in Development: Structures, Processes and Impacts	11:15 a.m. – 12:30 p.m.	Rhode Island
● Citizen Engagement in the Age of Microblogging and Open Government	11:15 a.m. – 12:30 p.m.	North Carolina
● The Economics of Infrastructure	11:15 a.m. – 12:30 p.m.	New Hampshire
● Crisis Planning and Administration for a Safe Community	11:15 a.m. – 12:30 p.m.	New Jersey
● Igniting Passion for Public Service: A Regional Effort to Promote Public-Sector Careers and Increase Civic Engagement	11:15 a.m. – 12:30 p.m.	Suite 230
● Refining and Redefining Performance and Accountability of Local Governance	11:15 a.m. – 12:30 p.m.	Senate
● Human Resources Management: Utilizing Talent, Goals and Public Service Motivation to Meet Organizational Goals	11:15 a.m. – 12:30 p.m.	South Carolina
● Network Governance and Complex Systems in Public Administration: What Have We Learned, Where Are We Going and How Can We Best Inform Practice?	11:15 a.m. – 12:30 p.m.	Independence
● Lighting Up the Darkness: Building Awareness, Transparency and Action to Drive Away Marginalization	11:15 a.m. – 12:30 p.m.	Pennsylvania
● Equity in Community and Workplace	11:15 a.m. – 12:30 p.m.	Maryland
● From Theory to Practice: Emotional Labor in the Workplace	11:15 a.m. – 12:30 p.m.	Massachusetts
● Presidential Panel—America’s Infrastructure: Is a D+ Acceptable? (<i>Infrastructure Focus</i>)	12:45 p.m. – 2:00 p.m.	Chinese Ballroom

MARCH 11 Monday Sessions

TRACKS: ● Public Finance ● Infrastructure ● Social Equity ● Public Service ● Global PA

SESSION	TIME	Room
● Collaborative Disaster Governance in East Asia: A Comparative Approach	12:45 p.m. - 2:00 p.m.	New York
● Advancing Excellence in City and Community Management	12:45 p.m. - 2:00 p.m.	New Hampshire
● Defining "Publics" through Environmental Administration in New Areas: Through a Glass, Darkly	12:45 p.m. - 2:00 p.m.	Virginia
● Leadership and Governance in Times of Crisis	12:45 p.m. - 2:00 p.m.	New Jersey
● Critical Issues in Infrastructure Workforce and Policymaking	12:45 p.m. - 2:00 p.m.	Massachusetts
● International Perspectives on Effective Collaboration and Innovation in Good Governance	12:45 p.m. - 2:00 p.m.	Rhode Island
● Korean Association for Policy Studies (KAPS) Session	12:45 p.m. - 2:00 p.m.	Pennsylvania
● Civic Engagement and Public Participation	12:45 p.m. - 2:00 p.m.	Senate
● The Wave of 2018: The Rising Tide of New Leaders	12:45 p.m. - 2:00 p.m.	Suite 230
● Local Law Enforcement's Practices of Discretion and Discrimination: Human Rights and Ethics in Marginalized Communities	12:45 p.m. - 2:00 p.m.	North Carolina
● Ethics and Equity Issues Faced by Editors of Scholarly Journals	12:45 p.m. - 2:00 p.m.	South Carolina
● Equitable Care: Shifting Health Systems to Care for Vulnerable Populations	12:45 p.m. - 2:00 p.m.	Maryland
● Strengthening Women's Leadership in Middle Eastern Public Administration and Civil Society	12:45 p.m. - 2:00 p.m.	Independence
● Presidential Panel—Census 2020: A Count That Matters <i>(Social Equity Focus)</i>	2:15 p.m. - 3:30 p.m.	Chinese Ballroom
● Presidential Panel—Developing the Next Generation of Public Service Leaders <i>(Public Service Focus)</i>	3:45 p.m. - 5:00 p.m.	Chinese Ballroom
● Mentoring and the Use of Organizational Stories: Increasing Engagement in the New Workforce	3:45 p.m. - 5:00 p.m.	North Carolina
● 9th National Annual Capstone Panel	3:45 p.m. - 5:00 p.m.	Senate
● Ethical Issues	3:45 p.m. - 5:00 p.m.	Massachusetts
● Advancing Public Service: Values That Make a Difference in Theory and Practice	3:45 p.m. - 5:00 p.m.	Independence
● Reconceptualizing Public Administration: Toward a New Paradigm of Public Governance and Societal Inquiry	3:45 p.m. - 5:00 p.m.	Pennsylvania
● KAPA Session—Understanding Public Officials in Korea	3:45 p.m. - 5:00 p.m.	Rhode Island
● Infrastructure Changes for the Future in the Aftermath of a Major Disaster	3:45 p.m. - 5:00 p.m.	New Hampshire
● New Theoretical and Methodological Insights from the 2017 Hurricane Season: Transitioning from Relief to Long-Term Recovery	3:45 p.m. - 5:00 p.m.	New Jersey
● Public Branding at the Local Government Level	3:45 p.m. - 5:00 p.m.	Virginia
● Environmental Federalism and Its Discontents: Environmental and Natural Resource Administration When the Center and the Periphery Disagree	3:45 p.m. - 5:00 p.m.	Maryland
● Challenges, Initiatives and Insights: Visible and Not So Visible Biases and Barriers to Gender Equity in Public Service	3:45 p.m. - 5:00 p.m.	South Carolina
● Administrative Failures and Social Equity	3:45 p.m. - 5:00 p.m.	New York
SPLA Meeting	5:30 p.m. - 6:30 p.m.	Maryland
SPOD Meeting	5:30 p.m. - 6:30 p.m.	New Hampshire
Brigham Young University Ice Cream Social and Founders' Fellows Reception	6:30 p.m. - 7:30 p.m.	Pennsylvania
National Public Service Awards Reception	6:30 p.m. - 7:30 p.m.	New York
CU Denver, UCCS, CSU and Colorado Chapter of ASPA Reception <i>(RSVP required)</i>	6:30 p.m. - 7:30 p.m.	North Carolina

TRACKS: ● Public Finance ● Infrastructure ● Social Equity ● Public Service ● Global

SWPA National Awards Breakfast

7:45 a.m. - 9:15 a.m. District Ballroom
(Ticketed Event)

LECTURER

Susan T. Gooden

Professor and Interim Dean, L. Douglas Wilder School of Public Affairs, Virginia Commonwealth University

Presidential Panel

8:00 a.m. - 9:15 a.m. Chinese Ballroom

Managing Our Country's Watershed Infrastructure

Infrastructure

MODERATOR

John Kirlin

Distinguished Professor of Public Policy, University of the Pacific McGeorge School of Law

PRESENTERS

Carin Bisland

Associate Director, Office of Partnerships and Accountability, Environmental Protection Agency

James Davis-Martin

VaDEQ and Chair, Chesapeake Bay Program's Water Quality Goal Implementation Team

Mary Gattis

Local Engagement and Environmental Policy Strategist

Panels

8:00 a.m. - 9:15 a.m. New Jersey

Strategies for Successful Emergency Management Performance

Infrastructure

Endorsed By:

Section on Emergency and Crisis Management and
Section on Environmental and Natural Resources
Administration

MODERATOR/PRESENTER

Sean Hildebrand

Assistant Professor, Ball State University
*The Crossroads of Emergency Management: Indiana
and Emergency Management Policy Implementation*

PRESENTER

Young-hwan Jeon

Doctoral Student, University of North Texas
*Defining the Gap Between Emergency Law and
Academic Scholar: Meta-Analysis on Korean Emergency
Management Journals (1992-2018) and Korean
Emergency Management Special Laws (2008-2018)*

PRESENTERS/COAUTHORS

David Capelli

Co-Founder and Director of Business Development,
#SmartCohort
*Emergency Management Capacity Building for
Vulnerable Communities: Governance Opportunities and
Challenges*

Carla Mays

Co-Founder and Head of Research, #SmartCohort
*Emergency Management Capacity Building for
Vulnerable Communities: Governance Opportunities and
Challenges*

Panels *(continued)*

8:00 a.m. - 9:15 a.m.

Suite 230

Infrastructure in Motion: Transportation Issues

Infrastructure

Endorsed By:

Section on Environmental and Natural Resources Administration and Section on Transportation Policy and Administration

PRESENTERS

Myungjung Kwon

Associate Professor, California State University—Fullerton

Understanding the Impact of Smart Cities on the Success of Autonomous Vehicles

Nick Valla

MPA Candidate and Tuition Scholar, Villanova University
California High Speed Rail: An Expensive, Counter-Cultural Ride with No Destination in Sight

PRESENTERS/COAUTHORS

Qianli Yuan

Doctoral Student, University at Albany, The State University of New York
Creating Public Value in Co-Production of Public Service: Evidence from the Bike Sharing Program in Shanghai, China

Yunxiang Zhang

Assistant Professor, Shanghai Normal University
Creating Public Value in Co-Production of Public Service: Evidence from the Bike Sharing Program in Shanghai, China

8:00 a.m. - 9:15 a.m.

Virginia

Governance in the Era of Internet Technology: Examples from China and South Korea

Infrastructure

Endorsed By:

Section on Chinese Public Administration and Section on Science and Technology in Government

PRESENTER

Xiang Gao

Associate Professor, Zhejiang University
Mobilize Toward a Weberian Bureaucracy? A Case Study of ICT-Driven Government Reform in Zhejiang Province

PRESENTERS/COAUTHORS

Li-jun Chen

Professor, Zhejiang University
NIMBY Protests Under the Rise of Citizens' Environmental Awareness: A Successful Petition or a Reflection of Petition Dilemma?

Hyesu Im

Doctoral Student, Penn State Harrisburg
Technological Revolution and Citizen E-Participation: Tracking the Evolution of Channels, Applications and Policy

Sol Jeong

Doctoral Student, Yonsei University
The Enlarging Role and Polymorphic Decisionmaking of Local Governments: Youth-Related Ordinance in Korea

COAUTHORS

Yong Suk Jang

Professor, Yonsei University
The Enlarging Role and Polymorphic Decisionmaking of Local Governments: Youth-Related Ordinance in Korea

Younhee Kim

Associate Professor, Penn State Harrisburg
Technological Revolution and Citizen E-Participation: Tracking the Evolution of Channels, Applications and Policy

Hoa Thai

Student, Yonsei University
Technological Revolution and Citizen E-Participation: Tracking the Evolution of Channels, Applications and Policy

8:00 a.m. - 9:15 a.m.

Rhode Island

Advancing Public Service through Collaborative Technologies

Infrastructure

Endorsed By:

Section on Democracy and Social Justice, Section on Public Administration Research and Section on Science and Technology in Government

MODERATOR

Michael Ahn

Associate Professor, University of Massachusetts—Boston and Visiting Professor (2017-2018), Seoul National University

Panels *(continued)*

PRESENTERS

Yu-Che Chen

Professor and Director, University of Nebraska—Omaha
Leveraging Collaborative Technology for Performance: Insight from an Experimental Study

Akhlaque Haque

Professor, University of Alabama—Birmingham
Information Technology and Social Equity: How Databases Discriminate Minority Issues

Eli Turkel

Doctoral Student, University of Delaware
The Attributes of Civic Technology: Drawing Lessons from Various Levels of Governance

PRESENTERS/COAUTHORS

Georgette Dumont

Associate Professor, University of North Florida
Connecting Technology to Public Value

Xian Gao

Doctoral Student, University of Nebraska—Omaha
Leveraging Collaborative Technology for Performance: Insight from an Experimental Study

Veronica Junjan

Assistant Professor, University of Twente
Technology Investments in Local Governments: What Is Promised and What Is Delivered? A Comparative Analysis in Dutch Local Governments

Ryan McDonagh

Booz Allen Hamilton
Connecting Technology to Public Value

Rene Torenvlied

Professor, University of Twente
Technology Investments in Local Governments: What Is Promised and What Is Delivered? A Comparative Analysis in Dutch Local Governments

8:00 a.m. - 9:15 a.m.

Senate

Systematic Explanations of Corruption

Global Public Administration

Endorsed By:

International Chapter, Section on Chinese Public Administration and Section on Democracy and Social Justice

MODERATOR

David Jancsics

Assistant Professor, San Diego State University

DISCUSSANT

Paul Lagunes

Assistant Professor, Columbia University

PRESENTER

Yingyao Wang

Assistant Professor, University of Virginia
A Network-Exchange Approach to Corruption: An Analysis of a Chinese Corruption Network

PRESENTERS/COAUTHORS

Whitney Afonso

Assistant Professor, University of North Carolina—Chapel Hill
Ethics By Design: The Impact of Form of Government on Municipal Corruption

Can Chen

Assistant Professor, Florida International University
A Meta-Analysis of the Effects of Government Decentralization on Corruption

Stan Korotchenko

Doctoral Student, University of Central Florida
Post-Soviet Style of Making Business: Bribes as a Dispute Resolution Tool in Courts

Mingfeng Kuo

Assistant Professor, National Taiwan University
Drivers of Bureaucratic Corruptibility: Rational, Irrational and Beyond

Olga Pysmenna

Doctoral Student, University of Central Florida
Post-Soviet Style of Making Business: Bribes as a Dispute Resolution Tool in Courts

Panels *(continued)*

COAUTHORS

Taiping Ding

Doctoral Student, Sun Yat-sen University
Drivers of Bureaucratic Corruptibility: Rational, Irrational and Beyond

Jinyun Guo

Associate Professor, Sichuan University
Drivers of Bureaucratic Corruptibility: Rational, Irrational and Beyond

Jiahuan Lu

Assistant Professor, Rutgers University—Newark
A Meta-Analysis of the Effects of Government Decentralization on Corruption

Kimberly Nelson

Associate Professor, University of North Carolina—Chapel Hill
Ethics by Design: The Impact of Form of Government on Municipal Corruption

Yahong Zhang

Associate Professor, Rutgers University—Newark
Drivers of Bureaucratic Corruptibility: Rational, Irrational and Beyond

8:00 a.m. - 9:15 a.m.

South Carolina

Environmental Pollution, Political Trust and Governance

Global Public Administration

Endorsed By:

Association for Budgeting and Financial Management, Section on Chinese Public Administration, Section on Complexity and Network Studies, Section on Democracy and Social Justice and Section on Environmental and Natural Resources Administration

MODERATOR

Marc Holzer

Distinguished Professor, Suffolk University

DISCUSSANT

Hong Liu

Professor, Nanyang Technological University

PRESENTER

Shihong Weng

Associate Professor, East China Normal University
Key Actors in Civic Participation and Government Response: Comparative Case Studies of NIMBY in China

PRESENTERS/COAUTHORS

Timothy Durham

MPA Student, Penn State Harrisburg
Project Governance in Chinese Infrastructure Public-Private Partnerships

Fanrong Meng

Associate Professor, Xi'an Jiaotong University
Environmental Regulation Instruments and Industrial Environmental Efficiency: Policy Choices and Their Impacts

Long Wu

Doctoral Graduate Student, Xi'an Jiaotong University
Land Financing and Environmental Governance: Evidence from China

Libo Yang

Doctoral Student, Xi'an Jiaotong University
Why Did Voluntary Environmental Agreements Fail in China?

Wenxuan Yu

Professor, Xiamen University
Fiscal Transparency and Benevolent Public Officials in Urban China

Renxian Zhu

Professor, Xiamen University
Fiscal Transparency and Benevolent Public Officials in Urban China

COAUTHORS

Zitao Chen

Graduate Student, Shanghai Jiaotong University
Environmental Regulation Instruments and Industrial Environmental Efficiency: Policy Choices and Their Impacts

Xinyu Dong

Associate Professor, Xi'an Jiaotong University
Why Did Voluntary Environmental Agreements Fail in China?

Bing Ran

Associate Professor, Penn State Harrisburg
Project Governance in Chinese Infrastructure Public-Private Partnerships

Panels *(continued)*

Bo Yan

Associate Professor, Xi'an Jiaotong University
Land Financing and Environmental Governance: Evidence from China

8:00 a.m. - 9:15 a.m.

New Hampshire

Emerging Urban and Regional Governance Issues in China

Global Public Administration

Endorsed By:

International Chapter, Section on Chinese Public Administration, Section on Complexity and Network Studies, Section on Environmental and Natural Resources Administration and Section on Intergovernmental Administration and Management

MODERATOR/PRESENTER

Lin Ye

Professor, Sun Yat-sen University
Collaborative Governance in the Greater Bay Area in China

PRESENTER

Yuze Yang

Doctoral Student, Sun Yat-sen University and University of North Texas
The Rise of Regionalism in China: Case Studies of City Annexation

PRESENTERS/COAUTHORS

Bin Chen

Associate Professor, Baruch College and the Graduate Center, City University of New York
Interprovincial Collaboration in the Pan-Pearl River Delta: Symmetric or Asymmetric?

Shengli Guo

Professor, East China University of Science and Technology
Social Organization under the Logic of Administrative and Market: Analysis of Homeowners Committees' Associations

Jie Ma

Associate Professor, University of Electronic Science and Technology of China
Interprovincial Collaboration in the Pan-Pearl River Delta: Symmetric or Asymmetric?

Yongdong Shen

Associate Professor, Zhejiang University
A Comparative Analysis of Ad Hoc Air Quality Governance for Mega Events in China

Liming Suo

Professor, University of Electronic Science and Technology of China
Interprovincial Collaboration in the Pan-Pearl River Delta: Symmetric or Asymmetric?

Bo Yan

Associate Professor, Xi'an Jiaotong University
Public Service Delivery, Resource Acquisition and Innovation Performance of SMEs

Liang Zhang

East China University of Science and Technology
Social Organization under the Logic of Administrative and Market: Analysis of Homeowners Committees' Associations

Ye Zheng

Assistant Professor, Northwestern Polytechnical University
Public Service Delivery, Resource Acquisition and Innovation Performance of SMEs

COAUTHORS

Anna Ahlers

Professor, University of Oslo
A Comparative Analysis of Ad Hoc Air Quality Governance for Mega Events in China

Chunping Wang

Professor, Northwestern Polytechnical University
Public Service Delivery, Resource Acquisition and Innovation Performance of SMEs

8:00 a.m. - 9:15 a.m.

Maryland

AIRMAP Session—Advancing in French Public Services

Global Public Administration

Endorsed By:

Section on Ethics and Integrity in Governance

MODERATOR/PRESENTER

Pierre-Charles Pupion

Professor and Chairman, AIRMAP, Université De Poitiers, IPAG
Ethics: A Way to Improve the Administration in France

Panels *(continued)*

PRESENTERS

Laurent Bouchard

Senior Associate Professor, University of Poitiers
Advancing the Understanding Between Citizens and Public Administration: The Recognition in French Law of the Right for Users of Public Services to Make a Mistake

Yves Chappoz

Professeur des Universités, IaeLyon School of Management
Integrating ICT in Public Services: Toward a Multidimensional Approach

David Huron

Associate Professor and Vice Chair, AIRMAP, Université Côte D'Azur
Digitization of Smart Cities: The Research of Marketing Positioning and Public Service Improvement

Erick LeRoux

Associate Professor, University of Paris
French Universities and Sustainable Development: New Issues to Improve Transparency, Ethics and Efficiency?

PRESENTERS/COAUTHORS

Philippe Dorbaire

Chairman, Confucius Institute, Université De Poitiers, IPAG
Ethics: A Way to Improve the Administration in France and French Universities and Sustainable Development: New Issues to Improve Transparency, Ethics and Efficiency?

Laurence Morgana

Associate Professor, Conservatory of Industrial Sciences and Information Technology
Ethics: A Way to Improve the Administration in France

8:00 a.m. - 9:15 a.m.

New York

New Thinking on Public Service Values: Considering the Role of Emotions and Empathy in Public Service

Public Service

Endorsed By:

Section for Women in Public Administration, Section on Health and Human Services Administration, Section on Public Administration Research and Students and New Administration Professionals Section

MODERATOR/PRESENTER

Stephanie Dolamore

Research Analyst, University of Baltimore
The Role of Empathy in Public Service: A Case Study of the Court Navigators Program at the University of Baltimore

PRESENTERS

Lori Brainard

Associate Professor, George Washington University
Empathy and Dialogue about Privilege and Inclusion: Early Results from a New PA Course

Mariglynn Edlins

Assistant Professor, University of Baltimore
Developing a Model of Empathy for Public Administration

PRESENTERS/COAUTHORS

Shama Akhtar

Director, Institutional Research, Bowie State University
Training the 21st Century Administrator: Experiences from the Trenches

Einat Lavee

Assistant Professor, University of Haifa
The Emotional Labor of Frontline Public Service Providers for the Poor

Roni Strier

Associate Professor, University of Haifa
The Emotional Labor of Frontline Public Service Providers for the Poor

COAUTHOR

Angela Kline

Assistant Professor, Bowie State University
Training the 21st Century Administrator: Experiences from the Trenches

Panels *(continued)*

8:00 a.m. - 9:15 a.m. North Carolina

Why Research Matters: Promoting Social Equity in a Responsive System of Governance

Social Equity

Endorsed By:

Section for Women in Public Administration, Section on Democracy and Social Justice, Section on Environmental and Natural Resources Administration, Section on Ethics and Integrity in Governance and Section on Health and Human Services Administration

MODERATOR/PRESENTER

RaJade Berry-James

Associate Professor of Public Administration, North Carolina State University, School of Public and International Affairs

DISCUSSANT/PRESENTER

Soumya Bhat

Director, Early Childhood Equity Initiatives, The Policy Equity Group
Highlighting Our Spectrum of Opportunities to Promote Social Equity

PRESENTERS

Samuel Brown

Professor and Chair, Old Dominion University
Examining the Neighborhood Effect on Health Care Disparities

Harvey White

Professor, University of Delaware
Environmental Justice as a Social Equity

Blue Wooldridge

Professor, Virginia Commonwealth University
Why All Public Administrators Need to Be Competent in Social Justice and Social Equity and the Application of Organizational Justice

8:00 a.m. - 9:15 a.m.

Pennsylvania

Public Service for All: Toward Equitable Organizations and Policy

Social Equity

Endorsed By:

Association for Budgeting and Financial Management, Section on Democracy and Social Justice, Section on Ethics and Integrity in Governance and Section on Public Administration Research

MODERATOR/DISCUSSANT

Jonathan Justice

Professor, University of Delaware

PRESENTERS

Sara Friedman

Doctoral Student, Portland State University
Providing Equitable Access to the U.S. Workforce for Highly Skilled Immigrants: Exploring U.S. State Policies Facilitating English Language Proficiency and Re-Credentialing

Jillian Girard

Senior Research and Evaluation Analyst, Multnomah County, Oregon
Gendered Behavior as a Factor in Pay Equity

Sara Spiers

Researcher, Portland State University
Addressing Equity in Fire Service: Workplace Culture Assessment Study

Ben Tafoya

Director, Office of the State Auditor, Massachusetts
Case Studies on How Practitioners and Academics Can Promote Social Equity

PRESENTERS/COAUTHORS

Sarah Gilliland

Senior Research Librarian, U.S. Government Accountability Office
Bureaucratic Representation and Strategic Planning: Emphasizing Equity

Masami Nishishiba

Department Chair and Associate Professor, Portland State University
Developing Capacity for Equity Work Among Nonprofit Organizations: Assessment of the Year-Long Equity Initiative

Panels *(continued)*

Steven Putansu

Senior Social Science Analyst, U.S. Government
Accountability Office
*Bureaucratic Representation and Strategic Planning:
Emphasizing Equity*

8:00 a.m. - 9:15 a.m. Independence

With an Ardent Focus on Equity: New Scholars' Approaches to Fairness and Justice Research, Practice and Instruction

Social Equity

Endorsed By:

Section for Women in Public Administration, Section on Democracy and Social Justice, Section on Ethics and Integrity in Governance and Students and New Administration Professionals Section

MODERATOR/PRESENTER

Lindsey Evans

Assistant Professor, University of Louisville
An Appeal for HOPE: Social Equity Access and Georgia's Lottery Funded Scholarship

PRESENTERS

Angela Kline

Assistant Professor, Bowie State University
Teaching with Henrietta Lacks: Metacognitive Conversations on Privilege and Identity in Qualitative Research Methods Courses

Simone Martin

Assistant Professor, Long Island University
The Impact of Needle Exchange Programs on Drug Use and Criminal Activity: A Case Study of a Community-Based Organization in New York City

Anthony Starke

Doctoral Student, University of Nebraska
Examining the Impact of Policy Narratives on Policy Design: An Interpretivist Analysis of Bureaucrats' Narratives, U.S. Welfare Policy Reform and the Social Construction of Welfare Recipients

PRESENTERS/COAUTHORS

Barbara Patrick

Associate Professor, Eastern Michigan University
The Emergence of Social Media as a Tool for Law Enforcement Agencies to Promote More Equitable and Just Services

Aaron Rollins

Assistant Professor, University of Louisville
The Emergence of Social Media as a Tool for Law Enforcement Agencies to Promote More Equitable and Just Services

8:00 a.m. - 9:15 a.m.

Massachusetts

Local Immigrant Integration and Its Relationship to Today's Polarized Immigration Policy Debate

Social Equity

Endorsed By:

International Chapter, Section for Women in Public Administration, Section on Democracy and Social Justice and Section on Ethics and Integrity in Governance

PRESENTERS

Christine Brenner

Associate Professor, University of Massachusetts—Boston
Dismantling Refugee Resettlement Infrastructure: Trump's Impact on Local Community Capacity

Neil Hernandez

Assistant Professor, Baruch College
Immigration Expansion and Restriction: The Reorganization of the U.S. Immigration System, 1906-1913

Grant Rissler

Affiliate Faculty, Virginia Commonwealth University
Immigrant Equity in Practice: A Deeper Conceptual Model for Factors Driving Local Government Responses Toward Immigrants

PRESENTERS/COAUTHORS

Thomas Bryer

Professor, University of Central Florida
Non-Economic Factors of Emigration: Development of a Theoretical and Practical Intervention Framework

Angela Paez

Assistant Professor, Tennessee State University
Exploring How Hostile State Legal Contexts Influence Minorities' Decision to Vote

Linda Williams

Assistant Professor, University of Texas at Rio Grande Valley
Exploring How Hostile State Legal Contexts Influence Minorities' Decision to Vote

Exhibit Hall

9:00 a.m. - 3:00 p.m. State and East Rooms

Donald C. Stone Lecture

9:30 a.m. - 11:00 a.m. Grand Ballroom

Sponsored By:
University of Pittsburgh, Graduate School of Public and International Affairs

LECTURER

Sylvia M. Burwell

President, American University

MASTER OF CEREMONIES

J. Paul Blake

District IV Representative, ASPA National Council

Presidential Panel

11:15 a.m. - 12:30 p.m. Chinese Ballroom

#MeToo: The Role of Universities in the MeToo Movement

Social Equity

MODERATOR

Charles E. Menifield

Dean, Rutgers University—Newark

PRESENTERS

Rajade Berry-James

Associate Professor of Public Administration, North Carolina State University, School of Public and International Affairs

Nicole Elias

Assistant Professor, John Jay College of Criminal Justice, City University of New York

Donna Greco

Policy Director, Pennsylvania Coalition Against Rape

Mindy Weinstein

Acting Director, Equal Employment Opportunity Commission, Washington Field Office

Founders' Fellows Panel

11:15 a.m. - 12:30 p.m. Virginia

Public Human Resource Management Practices and Strategies

MODERATOR/PRESENTER

Nuri Heckler

Doctoral Student, University of Colorado Denver
Camaraderie, Color-Blindness and Work Trends: Whiteness in Public People Management

PRESENTERS

Edgar Bustos

Doctoral Student, Centro de Investigación y Docencia Económicas

The Effect of Reputation on Recruitment: The Case of the Constitutional Autonomous Agencies in Mexico

Emmy Hicks

MPA Student, Louisiana State University

Utilizing Collaborative Efforts across Multiple Disciplines in Higher Education as an Engine to Promote Social Change while Generating Interest in Higher Education Programs

Joseph Maya Rodríguez

MPA Student, Rutgers University—Newark

Representation and Technology: Challenges for Public Administration

Mustafa Sen

Doctoral Student, Mississippi State University

How Do Emergent Strategies Affect Strategic Planning in Public Sector?

Panels

11:15 a.m. - 12:30 p.m. New York

SKPA Panel—Advancing Public Services Learned from the Korean Government Cases

Global Public Administration

Endorsed By:

International Chapter, Section on Complexity and Network Studies

MODERATOR

Jooho Lee

Associate Professor, University of Nebraska—Omaha

Panels (continued)

PRESENTER

Jeehee Han

Doctoral Student, Syracuse University
More Than Just Food: Unintended Consequences of Universal Free Meals in the Case of South Korea

PRESENTERS/COAUTHORS

HyeonUk Bak

Doctoral Student, Virginia Commonwealth University
Unpacking the Transformational Leadership-Innovative Work Behavior Relationship: The Roles of Psychological Capital, Autonomy and Public Service Motivation

Soojin Kim

Assistant Professor, Nanyang Technological University
Why Contracting Back-In? Evidence from South Korea and Singapore

Seulki Lee

Doctoral Student, New York University
When Tensions Become Opportunities: Managing Accountability Demands in Collaborative Governance

Sonia Ospina

Professor, New York University
When Tensions Become Opportunities: Managing Accountability Demands in Collaborative Governance

Eunju Rho

Assistant Professor, Northern Illinois University
Why Contracting Back-In? Evidence from South Korea and Singapore

COAUTHORS

Myung Jin

Associate Professor, Virginia Commonwealth University
Unpacking the Transformational Leadership-Innovative Work Behavior Relationship: The Roles of Psychological Capital, Autonomy and Public Service Motivation

In Won Lee

Associate Professor, University of Seoul
Unpacking the Transformational Leadership-Innovative Work Behavior Relationship: The Roles of Psychological Capital, Autonomy and Public Service Motivation

11:15 a.m. - 12:30 p.m.

Rhode Island

Multifaceted Governance in Development: Structures, Processes and Impacts

Global Public Administration

Endorsed By:

Section on Chinese Public Administration

MODERATOR/PRESENTER

Shaoming Cheng

Associate Professor, Florida International University
Polycentric Development in China's Megaregions: Definitions, Measurement and Implications

DISCUSSANT

Allan Rosenbaum

Professor, Public Administration and Director, Institute for Public Management and Center for Democracy and Good Governance, Florida International University

PRESENTERS/COAUTHORS

Jingan Chen

Research Fellow and Vice President, Sichuan Academy of Social Sciences

Research on Government Behavior of Cultural Communication in the Construction of the Tibetan, Qiang and Yi Nationality Cultural Corridor

Shi Chen

Assistant Fellow, Sichuan Academy of Social Sciences

Research on Government Behavior of Cultural Communication in the Construction of the Tibetan, Qiang and Yi Nationality Cultural Corridor

Huaxing Liu

Assistant Professor, Shandong University
How Much Do Young Local Civil Servants Trust Citizens in China? Empirical Evidence from the Post-Reform and Opening-Up Generations

Kun Zhai

Research Assistant, Sichuan Academy of Social Sciences

Research on Government Behavior of Cultural Communication in the Construction of the Tibetan, Qiang and Yi Nationality Cultural Corridor

COAUTHORS

Qing Huang

Assistant Professor, Shandong University
How Much Do Young Local Civil Servants Trust Citizens in China? Empirical Evidence from the Post-Reform and Opening-Up Generations

Panels *(continued)*

Min Xiong

Doctoral Student, Florida International University
Polycentric Development in China's Megaregions: Definitions, Measurement and Implications

11:15 a.m. - 12:30 p.m.

North Carolina

Citizen Engagement in the Age of Microblogging and Open Government

Infrastructure

Endorsed By:

Section for Women in Public Administration, Section on Democracy and Social Justice, Section on Public Administration Research and Section on Science and Technology in Government

MODERATOR/DISCUSSANT

Georgette Dumont

Associate Professor, University of North Florida

PRESENTERS

Samantha Amazan

MPA Student, Long Island University—Brooklyn
The Impact of E-Government on the Effectiveness of Public Administration

Sherri Greenberg

Clinical Professor, University of Texas at Austin
Digital Inclusion for Social and Economic Mobility

PRESENTERS/COAUTHORS

Michael Ahn

Associate Professor, University of Massachusetts—Boston and Visiting Professor (2017-2018), Seoul National University
"The Medium is the Message": The Rise of Microblogging, Our Social Media Bubbles and 2016 Presidential Election

Iseul Choi

Doctoral Student, University at Albany, The State University of New York
The Impact of Open Data Presentation on Citizens' Decisionmaking and Perceived Transparency: Evidence from an Online Survey Experiment

Yueping Zheng

Assistant Professor, Sun Yat-sen University
Explaining Citizen Engagement through Social Media: Evidence from Chinese Cities

COAUTHORS

Vishakha Agarwal

Doctoral Student, University of Massachusetts—Boston
"The Medium is the Message": The Rise of Microblogging, Our Social Media Bubbles and 2016 Presidential Election

J. Ramon Gil-Garcia

Associate Professor and Research Director, University at Albany, The State University of New York
The Impact of Open Data Presentation on Citizens' Decisionmaking and Perceived Transparency: Evidence from an Online Survey Experiment

Younhee Kim

Associate Professor, Penn State Harrisburg
"The Medium is the Message": The Rise of Microblogging, Our Social Media Bubbles and 2016 Presidential Election

Liang Ma

Associate Professor, Renmin University of China
Explaining Citizen Engagement through Social Media: Evidence from Chinese Cities

Bianca Ortiz-Wythe

Doctoral Student, University of Massachusetts—Boston
"The Medium is the Message": The Rise of Microblogging, Our Social Media Bubbles and 2016 Presidential Election

11:15 a.m. - 12:30 p.m.

New Hampshire

The Economics of Infrastructure

Infrastructure

Endorsed By:

Association for Budgeting and Financial Management and Section on Chinese Public Administration

MODERATOR/PRESENTER

Zhirong Zhao

Associate Professor, University of Minnesota
Transparency in State Infrastructure Gap Disclosure

PRESENTERS

Yanbing Han

Doctoral Student, Florida International University
Does Bundling in Public-Private Partnership Improve Efficiency? A Quasi-Experimental Approach

Panels *(continued)*

Laicheng Wen

Professor, Central University of Finance and Economics
Down, But Not Out: The “Clean-Up” of Public-Private Partnerships in China

PRESENTERS/COAUTHORS

Camila Fonseca

Research Associate, Institute for Urban and Regional Infrastructure Finance
Transparency in State Infrastructure Gap Disclosure

Chang-Gyu Kwak

Assistant Professor, Sejong University
Interlocal Economic Development Collaboration in Rural Metropolitan Areas: A Network Approach to the Case of Municipalities in West Texas

Sung-Wook Kwon

Associate Professor, Texas Tech University
Interlocal Economic Development Collaboration in Rural Metropolitan Areas: A Network Approach to the Case of Municipalities in West Texas

Jie Tan

Doctoral Student, Zhejiang University
Explaining the Landing Rate of Public-Private Partnerships in China’s Provinces: A Transaction Cost Perspective
and
Transparency in State Infrastructure Gap Disclosure

COAUTHOR

Zhirong Zhao

Associate Professor, University of Minnesota
Explaining the Landing Rate of Public-Private Partnerships in China’s Provinces: A Transaction Cost Perspective

11:15 a.m. - 12:30 p.m.

New Jersey

Crisis Planning and Administration for a Safe Community

Infrastructure

Endorsed By:

Section on Emergency and Crisis Management and
Section on Public Administration Research

MODERATOR/PRESENTER

Namkyung Oh

Associate Professor, University of Akron
Building an Integrated Governance Model for Chemical Incident Management: Lessons from Cases and Best Practices

PRESENTER

Ryan J. Scott

Advanced Strategic Planning and Policy Program Fellow,
North Carolina State
Defending Against the Next Domestic Crisis: A New U.S. Military Decisionmaking Dilemma

PRESENTERS/COAUTHORS

Lisa Dillard

Response Branch Chief, U.S. Department of Health and Human Services
The Strategic National Stockpile: Leveraging Military Experience for Gains in Public Health Emergency Preparedness

Ron Ottem

Community Resilience Activity Chief, U.S. Department of Health and Human Services
The Strategic National Stockpile: Leveraging Military Experience for Gains in Public Health Emergency Preparedness

Jason Rivera

Assistant Professor, Buffalo State, The State University of New York
Humanitarian Logistics: A Case Study of Hurricane Maria Disaster Relief in Puerto Rico

Jason Stear

Lead Policy and Issues Management Analyst, U.S. Department of Health and Human Services
The Strategic National Stockpile: Leveraging Military Experience for Gains in Public Health Emergency Preparedness

Panels *(continued)*

Alexis Willard

MPA Alumna, Buffalo State, The State University of New York

Humanitarian Logistics: A Case Study of Hurricane Maria Disaster Relief in Puerto Rico

COAUTHORS

Scott Drexler

Lead Emergency Management Specialist, U.S. Department of Health and Human Services

The Strategic National Stockpile: Leveraging Military Experience for Gains in Public Health Emergency Preparedness

Junghyae Lee

Adjunct Faculty, Kent State University

Building an Integrated Governance Model for Chemical Incident Management: Lessons from Cases and Best Practices

Workshop

11:15 a.m. - 12:30 p.m.

Suite 230

Igniting Passion for Public Service: A Regional Effort to Promote Public-Sector Careers and Increase Civic Engagement

Public Service

Endorsed By:

Section for Women in Public Administration and Students and New Administration Professionals Section

MODERATOR

Ann Braga

Director, Talent Acquisition Management and Employment, City of Boston Office of Human Resources
Mindful Leadership: Bringing Competencies Together for 21st Century Leaders

MODERATORS/PRESENTERS

Juliet Lee

Director, Administration and External Relations, University of Southern California

Randi Kay Stephens

Associate Program Manager, Institute for Local Government

Panels

11:15 a.m. - 12:30 p.m.

Senate

Refining and Redefining Performance and Accountability of Local Governance

Public Service

Endorsed By:

Association for Budgeting and Financial Management, Section for Women in Public Administration, Section on Chinese Public Administration, Section on Democracy and Social Justice and Section on Public Performance and Management

MODERATOR/PRESENTER

Elaine Yi Lu

Professor and Director, John Jay College of Criminal Justice, City University of New York

The Role of Discretion in Performance Accountability: Evidence from Chinese Municipal Governments

DISCUSSANT

Katherine Willoughby

Golembiewski Professor of Public Administration, University of Georgia

PRESENTER

Liwei Zhang

Professor, Jilin University and University of Illinois—Urbana-Champaign

“Sharing Pot” Behavior in China’s Local Government: Rethinking the Governmental Relationship Among China’s Administrative Systems

PRESENTERS/COAUTHORS

Taiping Ding

Doctoral Student, Sun Yat-sen University
Community Governance and Citizens’ Satisfaction: A Multigroup Structural Equation Analysis

Mingfeng Kuo

Assistant Professor, National Taiwan University
Community Governance and Citizens’ Satisfaction: A Multigroup Structural Equation Analysis

Mei Lang

Associate Professor, Lanzhou University
The Factors Influencing Innovation Sustainability Among Under-Developed Local Governments and the Overlap Effect: A Story from the Northwest Region of China

Panels *(continued)*

Xukang Tang

Student, Lanzhou University

The Role of Discretion in Performance Accountability: Evidence from Chinese Municipal Governments

COAUTHORS

Guorong Chai

Professor, Lanzhou University

Provincial Public Policy and Governance Effectiveness of Workplace Accidents: Evidence from Chinese Local Government

Wensheng He

Dean and Professor, Lanzhou University

The Role of Discretion in Performance Accountability: Evidence from Chinese Municipal Governments

Yating Jiang

Professor, Inner Mongolia University

Provincial Public Policy and Governance Effectiveness of Workplace Accidents: Evidence from Chinese Local Government

11:15 a.m. - 12:30 p.m.

South Carolina

Human Resources Management: Utilizing Talent, Goals and Public Service Motivation to Meet Organizational Goals

Public Service

MODERATOR/PRESENTER

So Hee Jeon

Assistant Professor, Central Michigan University

Do Family-Friendly Policies Work for All? Breaking Down the Effects by Sectors and Employee Characteristics

PRESENTER

Kuo-Tai Cheng

Professor, National Tsing Hua University

The Dark Knight Rises in Public Service: Could Public Service Motivation Enhance Counterproductive Work Behavior?

PRESENTERS/COAUTHORS

Karabi Bezboruah

Associate Professor, University of Texas at Arlington

Recruitment of Public Managers: Does Public Service Motivation Matter?

Li-Yi Hsu

Provost and Professor, National Open University

A Study of the Moderating Effects of Emotional Intelligence on the Relationship Between Goal Congruence, Work Engagement and Organizational Deviance Behavior

Hyungjo Hur

Postdoctoral Researcher, Ohio State University

Do Family-Friendly Policies Work for All? Breaking Down the Effects by Sectors and Employee Characteristics

H. T. Liu

Associate Professor, Ming Chung University

A Study of the Moderating Effects of Emotional Intelligence on the Relationship Between Goal Congruence, Work Engagement and Organizational Deviance Behavior

11:15 a.m. - 12:30 p.m.

Independence

Network Governance and Complex Systems in Public Administration: What Have We Learned, Where Are We Going and How Can We Best Inform Practice?

Public Service

Endorsed By:

Section on Complexity and Network Studies, Section on Emergency and Crisis Management, Section on Intergovernmental Administration and Management and Section on Public Administration Research

MODERATOR

Michael Siciliano

Assistant Professor, University of Illinois—Chicago

PRESENTERS

Louise Comfort

Professor, University of Pittsburgh

Richard Feiock

Professor, Florida State University

Naim Kapucu

Professor and Director, University of Central Florida

Christopher Koliba

Professor, University of Vermont

H. Brinton Milward

Professor and Director, University of Arizona

Panels *(continued)*

Branda Nowell

Professor, North Carolina State University

11:15 a.m. - 12:30 p.m.

Pennsylvania

Lighting Up the Darkness: Building Awareness, Transparency and Action to Drive Away Marginalization

Social Equity

Endorsed By:

Section for Women in Public Administration and Section on Democracy and Social Justice

MODERATOR/PRESENTER

Hillary Knepper

Associate Professor and Interim Associate Provost for Academic Affairs, Pace University

At the Crossroads of Health Care and Immigration: An Examination of Latino Immigrants' Anxiety over Health Care with Lessons for Practitioners

DISCUSSANT

Paris Wilson

Trauma Programs Fellow, Baltimore City Health Department

PRESENTERS

Patricia Alt

Professor Emerita, Towson University

Maintaining Valuable Baby Boomer Skills and Resources

Lyndsay Bates

Doctoral Student, University of Baltimore

Redevelopment and Displacement: A Historical Look at the Planning of Baltimore City's Downtown Central Business District

COAUTHORS

Ashley Kuenneke

Outreach Coordinator, Partnerships for Parks in Manhattan and New York City Department of Parks and Recreation

Participatory Budgeting: A Tool for Social Equity? Evidence from New York City

Karina Moreno

Assistant Professor, Long Island University—Brooklyn

At the Crossroads of Health Care and Immigration: An Examination of Latino Immigrants' Anxiety over Health Care with Lessons for Practitioners

Gina Scutelnicu

Assistant Professor, Pace University

Participatory Budgeting: A Tool for Social Equity? Evidence from New York City

11:15 a.m. - 12:30 p.m.

Maryland

Equity in Community and Workplace

Social Equity

Endorsed By:

Section for Women in Public Administration, Section on Democracy and Social Justice, Section on Ethics and Integrity in Governance, Section on Public Administration Research and Students and New Administration Professionals Section

PRESENTERS

Aiden Irish

Doctoral Student, Ohio State University

Trust in the Process: A Framework for Trust in Collaborative Governance

Ethelbert Chinedu Nwokorie

Assistant Professor, University of Vaasa

Equitable Welfare and Effective Public Service Delivery through Digitization: A Study of VAASA Municipality in Finland

PRESENTERS/COAUTHORS

Lauren Edwards

Assistant Professor, University of Maryland—Baltimore County

From Diversity to Inclusion: Promoting Inclusive Practices in Public Affairs Departments

Maja Holmes

Chair and Associate Professor, West Virginia University

From Diversity to Inclusion: Promoting Inclusive Practices in Public Affairs Departments

Dongjae Jung

Associate Research Fellow, Korea Institute of Public Administration

Social Equity, Social Conflicts and Conflict Management Institutions: The Case for Social Conflict Index

Vanessa Lopez-Littleton

Assistant Professor, California State University—Monterey Bay

Equity in Public Unions: Anti-Racism and Social Justice Transformation in the California Faculty Association

Panels *(continued)*

COAUTHORS

Marie Alonzo

Graduate Student, California State University—Monterey Bay

Equity in Public Unions: Anti-Racism and Social Justice Transformation in the California Faculty Association

Natalie Bauer

Graduate Student, California State University—Monterey Bay

Equity in Public Unions: Anti-Racism and Social Justice Transformation in the California Faculty Association

June Park

Research Fellow, Korea Institute of Public Administration
Social Equity, Social Conflicts and Conflict Management Institutions: The Case for Social Conflict Index

Jessica Sowa

MPA Director and Associate Professor, University of Baltimore

From Diversity to Inclusion: Promoting Inclusive Practices in Public Affairs Departments

11:15 a.m. - 12:30 p.m.

Massachusetts

From Theory to Practice: Emotional Labor in the Workplace

Social Equity

Endorsed By:

Section for Women in Public Administration, Section on Democracy and Social Justice and Section on Health and Human Services Administration

MODERATOR/PRESENTER

Mary Guy

Professor, University of Colorado Denver

From Theory to Practice: Emotional Labor in the Workplace

PRESENTERS

John Ford

Professor, University of Maryland—University College
Identifying Emotional Labor Language Features

J. Peter Leeds

Professor, University of Baltimore

Emotional Fatigue and Exhaustion: Implications and Research Findings

Sharon Mastracci

Professor, University of Utah

Making the Affective Turn: Feelings in Theory and Practice

Sharon Roth

Senior Research Analyst, U.S. Merit Systems Protection Board

Emotional Labor and False Face: The Price of Pretending

Presidential Panel

12:45 p.m. - 2:00 p.m.

Chinese Ballroom

America's Infrastructure: Is a D+ Acceptable?

Infrastructure

MODERATOR

Wendy Haynes

Special Assistant to the Vice President for University Advancement, Bridgewater State University

PRESENTERS

Casey Dinges

Senior Managing Director, Infrastructure Initiatives, American Society of Civil Engineers

Brandye Hendrickson

Deputy Administrator, Federal Highway Administration, Department of Transportation

Paul Wiedefeld

General Manager and Chief Executive Officer, Washington Metropolitan Area Transit Authority

Panels

12:45 p.m. - 2:00 p.m.

New York

Collaborative Disaster Governance in East Asia: A Comparative Approach

Infrastructure

Endorsed By:

International Chapter, Section on Chinese Public Administration, Section on Complexity and Network Studies, Section on Emergency and Crisis Management, Section on Intergovernmental Administration and Management and Section on Public Administration Research

MODERATOR

Louise Comfort

Professor, University of Pittsburgh

PRESENTER

Ssu-Ming Chang

Professor, National Taipei University
Decommissioning Management of the Nuclear Power Plant I in Taiwan: Stakeholder Participation and Social Communication

PRESENTERS/COAUTHORS

Chao Huang

Associate Professor, Sichuan University
Present Status and Development Trends of the Crowdsourcing Model for Disaster Management in China

B. Joon Kim

Associate Professor, Kookmin University
Developing the Integrated Mediation Model for Disaster Governance: Cognition, Attitude and Behavior of Risk Communication in Nuclear Energy Between Korea and Japan

Barsha Manandhar

Doctoral Student, Florida International University
Governing the Collaborative Network: A Case Study of Post-Disaster Recovery of 2015 Nepal Earthquake

Chun-yuan Wang

Associate Professor, Central Police University
Effective Network Management Strategies in Collaborative Disaster Governance: A Comparative Study on the Cases of Taiwan and Japan

COAUTHORS

Wonjun Chung

Associate Professor, University of Suwon
Developing the Integrated Mediation Model for Disaster Governance: Cognition, Attitude and Behavior of Risk Communication in Nuclear Energy Between Korea and Japan

Jiaming Dong

Doctoral Student, Sichuan University
Present Status and Development Trends of the Crowdsourcing Model for Disaster Management in China

Fengchun Fan

Professor, Sichuan University
Present Status and Development Trends of the Crowdsourcing Model for Disaster Management in China

Nazife Ganapati

Associate Professor, Florida International University
Governing the Collaborative Network: A Case Study of Post-Disaster Recovery of 2015 Nepal Earthquake

Wu Jing

Sichuan University
Present Status and Development Trends of the Crowdsourcing Model for Disaster Management in China

Masao Kikuchi

Associate Professor, Meiji University
Effective Network Management Strategies in Collaborative Disaster Governance: A Comparative Study on the Cases of Taiwan and Japan

Mingfeng Kuo

Assistant Professor, National Taiwan University
Effective Network Management Strategies in Collaborative Disaster Governance: A Comparative Study on the Cases of Taiwan and Japan

Jing Wu

Secretary, Sichuan University
Present Status and Development Trends of the Crowdsourcing Model for Disaster Management in China

Zhiqiang Xia

Professor, Sichuan University
Present Status and Development Trends of the Crowdsourcing Model for Disaster Management in China

Panels *(continued)*

12:45 p.m. - 2:00 p.m.

New Hampshire

Advancing Excellence in City and Community Management

Infrastructure

Endorsed By:

Section on Complexity and Network Studies, Section on Environmental and Natural Resources Administration, Section on Science and Technology in Government and Section on Transportation Policy and Administration

PRESENTER

Paul Broussard

Student, North Carolina State University
Energy Efficiency and the Lessons of Chattanooga's HEU Program

PRESENTERS/COAUTHORS

Christopher Hawkins

Associate Professor, University of Central Florida
Functional Collective Action and Intra-City Networks in Urban Sustainability

Rachel Krause

Associate Professor, University of Kansas
Changes in Perception and Reality: Public Knowledge of Plug-In Electric Vehicles in 21 U.S. Cities (2011-2017) and
Functional Collective Action and Intra-City Networks in Urban Sustainability

James Melitski

Professor, Marist College
Smart Cities and Online Branding

Adam Sawyer

MAIR Student, Syracuse University
Changes in Perception and Reality: Public Knowledge of Plug-In Electric Vehicles in 21 U.S. Cities (2011-2017)

COAUTHORS

Morgan Higman

Sustainability Analyst and Doctoral Student, Florida State University
Sustainable, Resilient: City Policy Responses to Climate Change

Aroon P. Manoharan

Associate Professor, University of Massachusetts—Boston
Smart Cities and Online Branding

Saba Siddiki

Professor, Syracuse University
Changes in Perception and Reality: Public Knowledge of Plug-In Electric Vehicles in 21 U.S. Cities (2011-2017)

12:45 p.m. - 2:00 p.m.

Virginia

Defining "Publics" through Environmental Administration in New Areas: Through a Glass, Darkly

Infrastructure

Endorsed By:

Section for Women in Public Administration, Section on Democracy and Social Justice, Section on Ethics and Integrity in Governance and Section on Environmental and Natural Resources Administration

MODERATOR/DISCUSSANT

Mary Klein

Consultant

PRESENTERS

Zach Mahafza

Doctoral Student, Auburn University
Fracking, Disposal Wells and Earthquakes: Mapping the New Frontier in Environmental Regulation

Paul Manson

Senior Research Assistant, Portland State University
Construction of the Public in Marine Spatial Planning

Jeremiah Muhammad

Policy Associate, Little Village Environmental Justice Organization
The Absence of Environmental Health and Equity in Our Land Use Policies

PRESENTERS/COAUTHORS

Mohammed Alkhurayyif

Doctoral Student, University of North Texas
Policies for Adapting to Climate Change in Saudi Arabia: A Content Analysis

Jong Youl Lee

Professor, Incheon University
Peer Pressure, Filial Piety and the Party: The Impact of Confucian Norms on Environmental Management at the Local Level in China

Panels *(continued)*

Seong-Gin Moon

Assistant Professor, Inha University
Peer Pressure, Filial Piety and the Party: The Impact of Confucian Norms on Environmental Management at the Local Level in China

Jill Tao

Associate Professor, Incheon National University
Peer Pressure, Filial Piety and the Party: The Impact of Confucian Norms on Environmental Management at the Local Level in China

Bo Wang

Lecturer, Guangxi Nationalities University
Peer Pressure, Filial Piety and the Party: The Impact of Confucian Norms on Environmental Management at the Local Level in China

COAUTHORS

Saad Alkhourayif

Doctoral Student, University of North Texas
Policies for Adapting to Climate Change in Saudi Arabia: A Content Analysis

Simon Andrew

Professor, University of North Texas
Policies for Adapting to Climate Change in Saudi Arabia: A Content Analysis

12:45 p.m. - 2:00 p.m.

New Jersey

Leadership and Governance in Times of Crisis

Infrastructure

Endorsed By:

Section on Emergency and Crisis Management and Section on Environmental and Natural Resources Administration

MODERATOR/PRESENTER

Branda Nowell

Professor, North Carolina State University
Governing the "New Normal": The Evolution of Network Management of Wildfires in an Era of Climate Change

PRESENTERS/COAUTHORS

Brie Haupt

Visiting Professor, Florida Atlantic University
Crisis Communication and Nonprofits: Implications from a Case Study on Reputational Threat

Jeongmin Oh

Doctoral Student, Florida State University
Building Disaster Resilience through Trust in Government: Lessons from Citizens, Experts and Public Managers' Perspective

COAUTHORS

Lauren Azevedo

Assistant Professor, Penn State Harrisburg
Crisis Communication and Nonprofits: Implications from a Case Study on Reputational Threat

Kyujin Jung

Assistant Professor, SungKyunKwan University
Building Disaster Resilience through Trust in Government: Lessons from Citizens, Experts and Public Managers' Perspective

Daewoong Lee

Doctoral Student, SungKyunKwan University
Building Disaster Resilience through Trust in Government: Lessons from Citizens, Experts and Public Managers' Perspective

Honey Minkowitz

Doctoral Student, North Carolina State University
Governing the "New Normal": The Evolution of Network Management of Wildfires in an Era of Climate Change

12:45 p.m. - 2:00 p.m.

Massachusetts

Critical Issues in Infrastructure Workforce and Policymaking

Infrastructure

Endorsed By:

Section on Democracy and Social Justice, Section on Ethics and Integrity in Governance and Section on Transportation Policy and Administration

MODERATOR/PRESENTER

Becky Lutte

Assistant Professor, University of Nebraska—Omaha
Women in Aviation: A Workforce Study

PRESENTERS/COAUTHORS

Anthony Campbell

Assistant Professor, Tennessee State University
Pedestrian Infrastructure as Politics and Policy: A Qualitative Analysis of How Local Governments Conceptualize Pedestrian Spaces

Panels *(continued)*

Josephine Hazelton

Doctoral Student, University of Nebraska—Omaha
Road Rage: Countering Vehicular Weaponization in the United States

COAUTHORS

Adam Blair

Doctoral Student, Tennessee State University
Pedestrian Infrastructure as Politics and Policy: A Qualitative Analysis of How Local Governments Conceptualize Pedestrian Spaces

Jacqueline Luedtke

Professor, Embry-Riddle Aeronautical University
Women in Aviation: A Workforce Study

Shannon Morrison

Coordinator, Diversity and Inclusion, Ohio State University
Women in Aviation: A Workforce Study

Cara Robinson

Assistant Professor, Tennessee State University
Pedestrian Infrastructure as Politics and Policy: A Qualitative Analysis of How Local Governments Conceptualize Pedestrian Spaces

Gerard Wellman

Associate Professor, California State University—Stanislaus
Road Rage: Countering Vehicular Weaponization in the United States

12:45 p.m. - 2:00 p.m.

Rhode Island

International Perspectives on Effective Collaboration and Innovation in Good Governance

Global Public Administration

Endorsed By:

International Chapter, Section on Public Administration Research

PRESENTERS

Vivian Cueto

Doctoral Student, Florida International University
Mutually Beneficial Collaboration? A Cross-Sectional Study on Perceptions of Engagement Between Town and Gown

Jung Wook Lee

Professor, Yonsei University
Testing the Efficacy of Structural Insulation of Public Agencies: The Case of the Korean Central Government Agencies

Joshua Zaato

Assistant Professor, Zayed University
Challenges and Realities of Administrative Reforms in the Developmental State

PRESENTER/COAUTHOR

Keon Hyung Lee

Professor and Director, Florida State University
Examining the Impact of External and Internal Control on Social Enterprise's Public Value Creation

COAUTHOR

Donwe Choi

Doctoral Student, Florida State University
Examining the Impact of External and Internal Control on Social Enterprise's Public Value Creation

12:45 p.m. - 2:00 p.m.

Pennsylvania

Korean Association for Policy Studies (KAPS) Session

Global Public Administration

MODERATOR

Younhee Kim

Associate Professor, Penn State Harrisburg

DISCUSSANTS

Michael Ahn

Associate Professor, University of Massachusetts—Boston and Visiting Professor (2017-2018), Seoul National University

B. Joon Kim

Associate Professor, Kookmin University

PRESENTERS/COAUTHORS

Yongjin Choi

Doctoral Student, University at Albany, The State University of New York
Public Hearing Testimonies as Policy Evidence and Their Influence over Policymakers: The Case of Single-Payer Issue in New York State

Panels *(continued)*

Gayoung Imm

Graduate Student, Yonsei University
Does Political Competition Affect Local Governments' Regulatory Behaviors?

Kyungmin Kim

Doctoral Student, Yonsei University
Does One Size Fit All? A Critical Approach to Smart Work

COAUTHORS

Ashley Fox

Assistant Professor, University at Albany, The State University of New York
Public Hearing Testimonies as Policy Evidence and Their Influence over Policymakers: The Case of Single-Payer Issue in New York State

Sounman Hong

Associate Professor, Yonsei University
Does Political Competition Affect Local Governments' Regulatory Behaviors?

Sangyub Ryu

Assistant Professor, Yonsei University
Does One Size Fit All? A Critical Approach to Smart Work

12:45 p.m. - 2:00 p.m.

Senate

Civic Engagement and Public Participation

Public Service

Endorsed By:

Section on Democracy and Social Justice and Section on Intergovernmental Administration and Management

PRESENTERS

Sinah Kang

Doctoral Student, Rutgers University
Crowdsourcing and Citizenship: An Experimental Approach

Ricardo Morse

Associate Professor, University of North Carolina—Chapel Hill
Practitioner Perspectives on Citizen Engagement: Main Themes and What They Mean for Practice

PRESENTERS/COAUTHORS

Vickie Edwards

Assistant Professor, Western Michigan University
Civic Engagement, Community Attachment and the Limitations of Social Media

Seunghui Lee

Doctoral Student, Syracuse University
Examining the Effects of Direct Public Participation: Two Local Participatory Projects

A.J. Million

Postdoctoral Fellow, University of Michigan
Civic Engagement, Community Attachment and the Limitations of Social Media

Alina Parbtani

Assistant Director and Doctoral Student, Florida International University
Engaged University: Lessons Learned through the Carnegie Reclassification Process

Sofia Trelles

Student Ombudsman, Florida International University
Engaged University: Lessons Learned through the Carnegie Reclassification Process

COAUTHOR

Tina Nabatchi

Associate Professor, Syracuse University
Examining the Effects of Direct Public Participation: Two Local Participatory Projects

12:45 p.m. - 2:00 p.m.

Suite 230

The Wave of 2018: The Rising Tide of New Leaders

Social Equity

Endorsed By:

Section for Women in Public Administration and Section on Democracy and Social Justice

MODERATOR

Ann Braga

Director, Talent Acquisition Management and Employment, City of Boston Office of Human Resources

Panels *(continued)*

12:45 p.m. - 2:00 p.m. North Carolina

Local Law Enforcement's Practices of Discretion and Discrimination: Human Rights and Ethics in Marginalized Communities

Social Equity

Endorsed By:

Section for Women in Public Administration, Section on Democracy and Social Justice, Section on Ethics and Integrity in Governance and Section on Intergovernmental Administration and Management

PRESENTERS

Galia Cohen

Associate Director and Senior Lecturer, Justice Administration and Leadership Program, University of Texas at Dallas
From Warriors Guardians: Transforming Law Enforcement Culture through Training

Karina Moreno

Assistant Professor, Long Island University—Brooklyn
Latino Perceptions of Law Enforcement's Implementation of the Secure Communities Policing Program

Melvin Rogers

Dean, University of Central Florida
Public Administration and Ethical Practices When Interacting with Law Enforcement

PRESENTERS/COAUTHORS

Jason Anastasopoulos

Assistant Professor, University of Georgia
Policing and Place: Preliminary Results from a Survey Experiment

Tia Sheree Gaynor

Assistant Professor, University of Cincinnati
To Protect and Serve or Control and Marginalize: Local Law Enforcement and the Denial of Civil and Human Rights

Megan LePere-Schloop

Assistant Professor, Ohio State University
Policing and Place: Preliminary Results from a Survey Experiment

Samara Scheckler

Doctoral Student, University of Georgia
Policing and Place: Preliminary Results from a Survey Experiment

COAUTHORS

Brandi Blessett

Associate Professor, University of Cincinnati
To Protect and Serve or Control and Marginalize: Local Law Enforcement and the Denial of Civil and Human Rights

Brian N. Williams

Associate Professor, University of Virginia
Policing and Place: Preliminary Results from a Survey Experiment

12:45 p.m. - 2:00 p.m. South Carolina

Ethics and Equity Issues Faced by Editors of Scholarly Journals

Social Equity

Endorsed By:

Section for Women in Public Administration, Section on Democracy and Social Justice and Section on Ethics and Integrity in Governance

MODERATOR/PRESENTER

Carole Jurkiewicz

Professor, Ethics and Public Integrity, University of Colorado Colorado Springs and Affiliate and Principal, Jurkiewicz and Associates, LLC
Ensuring Diversity, Dealing with Plagiarism and Double-Dipping: The Ethics of Indicating

PRESENTERS

Mary Feeney

Associate Professor, Arizona State University

Heather Getha-Taylor

Associate Professor, University of Kansas
Learning the Ropes: How to Anticipate Challenges and Set the Stage for Success as an Editor in Chief

Patricia Shields

Professor, Texas State University
What Ethical and Equity Factors Play into the Decision to Accept, Reject or Recommend Revise and Resubmit

Jessica Sowa

MPA Director and Associate Professor, University of Baltimore
Ensuring Ethicality and Equity in the Blind Peer Review Process

Panels *(continued)*

Staci Zavattaro

Associate Professor, University of Central Florida
Ethical Issues in Dealing with Authors and Handling Complaints

12:45 p.m. - 2:00 p.m.

Maryland

Equitable Care: Shifting Health Systems to Care for Vulnerable Populations

Social Equity

Endorsed By:

Section on Democracy and Social Justice, Section on Ethics and Integrity in Governance, Section on Health and Human Services Administration and Section on Public Administration Research

PRESENTERS

Kimberly Bracey

Teacher and Graduate Student, Walden University
Implementation of the Affordable Care Act and the Experiences of Parents with Chronically Ill Children

Karolyn Campbell

Graduate Student, University of Utah
Intergroup Contact Theory and Disability

PRESENTERS/COAUTHORS

Jacqueline Chattopadhyay

Associate Professor, University of North Carolina—Charlotte
Deservingness of Medicaid Recipients: The Influence of Altruism and Social Construction on Public Perceptions

Vanessa Fenley

Assistant Professor, University of Nevada—Las Vegas
Tensions in Practice: Medicaid Funding and Service Implementation

SeungHoon Han

Assistant Professor, Chung-Ang University
The Causal Impact of Flat-Rate Outpatient Cost Policy on the Elderly's Health Outcomes in Korea

Jaelyn Piatak

Assistant Professor, University of North Carolina—Charlotte
Deservingness of Medicaid Recipients: The Influence of Altruism and Social Construction on Public Perceptions

Adrian Velazquez Vazquez

Associate Professor, University of La Verne
Public-Private Partnerships as Alternatives to Traditional Public Administration: Transnational Health Care Access for Migrants

COAUTHORS

Alexis Kennedy

Public Finance Consultant and Doctoral Student Research Assistant, University of Colorado Denver
Tensions in Practice: Medicaid Funding and Service Implementation

Jennifer Newman

Lecturer, California State University
Public-Private Partnerships as Alternatives to Traditional Public Administration: Transnational Health Care Access for Migrants

12:45 p.m. - 2:00 p.m.

Independence

Strengthening Women's Leadership in Middle Eastern Public Administration and Civil Society

Social Equity

Endorsed By:

Association for Budgeting and Financial Management, International Chapter, Section for Women in Public Administration, Section on Democracy and Social Justice, Section on Effective and Sound Administration in the Middle East and Section on Ethics and Integrity in Governance

MODERATOR

Aziza Zembrani

Associate Professor and Chair, University of Texas at Rio Grande Valley

PRESENTERS

Emma Alpert

Producer and Public Engagement Manager, Just Vision
Progress for Palestinian Communities through Women's Leadership, Film and Dialogue

Lyn Boswell

International Consultant and Monitoring and Evaluation Expert, City of Temple Terrace, Florida
#MeToo and the Aftermath of the Women's Rights Movement in the Middle East

PRESENTERS/COAUTHORS

Khaldoun AbouAssi

Assistant Professor, American University
Formal or Informal Cross-Sector Collaborations: Testing Propositions from Prevailing Theories

Panels *(continued)*

Zachary Bauer

Doctoral Student and Charles Levine Research Fellow,
American University
*Formal or Informal Cross-Sector Collaborations: Testing
Propositions from Prevailing Theories*

Maria D'Agostino

Associate Professor and Chair, Department of Public
Management, John Jay College of Criminal Justice, City
University of New York
*Characterization of Women and Leadership in Public
Administration*

Jocelyn Johnston

Associate Professor, American University
*Formal or Informal Cross-Sector Collaborations: Testing
Propositions from Prevailing Theories*

COAUTHORS

Helisse Levine

Professor and MPA Director, Long Island University—
Brooklyn
*Characterization of Women and Leadership in Public
Administration*

Meghna Sabharwal

Associate Professor, University of Texas at Dallas
*Characterization of Women and Leadership in Public
Administration*

Presidential Panel

2:15 p.m. - 3:30 p.m. Chinese Ballroom

Census 2020: A Count That Matters

Social Equity

MODERATOR

Susan T. Gooden

Interim Dean, L. Douglas Wilder School, Virginia
Commonwealth University

PRESENTERS

Albert E. Fontenot, Jr.

Associate Director, Decennial Census Programs, United
States Department of Commerce

Mary Jo Hoeksema

Co-Director, The Census Project and Director of
Government Affairs, Population Association of America

Beth Lynk

Census Counts Campaign Director, The Leadership
Conference on Civil and Human Rights

Arturo Vargas

Chief Executive Officer, National Association of Latino
Elected and Appointed Officials (NALEO) Educational
Fund

Presidential Panel

3:45 p.m. - 5:00 p.m. Chinese Ballroom

Developing the Next Generation of Public Service Leaders

Public Service

MODERATOR

Bill Valdez

Chief Executive Officer, Senior Executives Association

PRESENTERS

Angela Bailey

Chief Human Capitol Officer, U.S. Department of
Homeland Security

Dustin Brown

U.S. Office of Management and Budget

Angela Evans

Dean, LBJ School, University of Texas at Austin

Robert Goldenkoff

Director, Strategic Issues Team, U.S. Government
Accountability Office

Workshop

3:45 p.m. - 5:00 p.m. North Carolina

Mentoring and the Use of Organizational Stories: Increasing Engagement in the New Workforce

Public Service

PRESENTER

Kathleen Immordino

Adjunct Professor, Rutgers University

Panels

3:45 p.m. - 5:00 p.m.

Senate

9th National Annual Capstone Panel

Public Service

MODERATOR

Philip Nufrio

Professor, Metropolitan College of New York

DISCUSSANT

Pamela Ransom

Associate Professor, Metropolitan College of New York

PRESENTERS

Meril Antony

Doctoral Student, Rutgers University—Newark
Digital Activism: Characteristics Influencing the Likelihood of Success of Digital Activism Campaigns

Talia Beaulieu-Hains

MPA Student, Metropolitan College of New York
Constructive Action: Case Studies That Improve the Service Delivery of New York City Human Service Agencies

Leroy Perkins

MPA Student, Metropolitan College of New York
Constructive Action: Case Studies That Improve the Service Delivery of New York City Human Service Agencies

PRESENTER/COAUTHOR

Jerry Martinez

MPA Student, University of Texas at Rio Grande Valley
Entrepreneurial Ecosystem Asset Mapping: A Client-Based Approach

3:45 p.m. - 5:00 p.m.

Massachusetts

Ethical Issues

Public Service

Endorsed By:

Association for Budgeting and Financial Management, Section on Democracy and Social Justice and Section on Ethics and Integrity in Governance

PRESENTERS

Sun Young Kim

Assistant Professor, University of Georgia
Can Ethics Management Contribute to Organizational Performance? Linking Ethics and Performance in Public Organizations

Robert Smith

Dean, University of Illinois—Springfield
The Ethics Infrastructure of the 21st Century: Some Observations and Implications over the Past 40 Years

Kenneth Williams

Senior Military Fellow, Department of Ethics, National Defense University
Addressing Senior Leader Ethical Misconduct through Organizational Culture

PRESENTERS/COAUTHORS

Asiyati Lorraine Chiweza

Associate Professor, Chancellor College, University of Malawi
Entrenching Ethical Values through Codes of Conduct in the Malawi Public Service

Minsung Michael Kang

Doctoral Student, University at Albany, The State University of New York
Is the New Shield Effective? The Impact of the Whistleblower Protection Enhancement Act on Bureaucrats' Whistleblowing Intention

COAUTHORS

Jisang Kim

Doctoral Student, University at Albany, The State University of New York
Is the New Shield Effective? The Impact of the Whistleblower Protection Enhancement Act on Bureaucrats' Whistleblowing Intention

Yapikachi Msiska

Assistant Lecturer and MA Student, Chancellor College, University of Malawi
Entrenching Ethical Values through Codes of Conduct in the Malawi Public Service

3:45 p.m. - 5:00 p.m.

Independence

Advancing Public Service: Values That Make a Difference in Theory and Practice

Public Service

Endorsed By:

Section on Democracy and Social Justice

MODERATOR/PRESENTER

Leo Huberts

Professor, Vrije Universiteit Amsterdam
Integrity and Quality of Governance

Panels *(continued)*

PRESENTERS

Neal Buckwalter

Associate Professor, Grand Valley State University
Democratic Legitimacy: A Precarious Balance of Values

Melvin Dubnick

Professor, University of New Hampshire
Accountability and Its Metaphors: From Forum to Agora and Bazaar

Adam Masters

Professor, Australian National University
Flawed Values: The Bureaucratic Animosity of the State Toward Its Citizens

3:45 p.m. - 5:00 p.m.

Pennsylvania

Reconceptualizing Public Administration: Toward a New Paradigm of Public Governance and Societal Inquiry

Global Public Administration

Endorsed By:

Section on Emergency and Crisis Management, Section on Environmental and Natural Resources Administration and Section on Public Administration Research

MODERATOR/PRESENTER

Michelle (Charles) Dennis

Director of Finance (Retired) and Teaching Lecturer, City of Santa Monica and University of California—Los Angeles
The Para-Economic Paradigm: Implementation Strategies

DISCUSSANT

Curtis Ventriss

Professor Emeritus and University Scholar, University of Vermont

PRESENTER

Brian Nakamura

Teaching Lecturer, University of Arkansas
Fiscalization of Land Use, Economic and Social Determinants Impacting Sustainable and Resilient Communities

PRESENTERS/COAUTHORS

Juyong Jung

Assistant Professor, Korea National University of Transportation
Am I a Scientist or a Government Employee? The Occupational Identity of Researchers at Korean National Research Institutes

Taewoo Nam

Associate Professor, SungKyunKwan University
Am I a Scientist or a Government Employee? The Occupational Identity of Researchers at Korean National Research Institutes

Luis Antonio Pittol Trevisan

MPA Student and 1st Lieutenant, Universidade Do Estado De Santa Catarina and Policia Militar Santa Catarina
Brazilian "Critical Assimilation" in American Case Studies of Emergency Management and Community Policy

Lais Silveira Santos

Doctoral Student and Administrator, Universidade Do Estado De Santa Catarina and Universidade Federal Do Santa Catar
Brazilian "Critical Assimilation" in American Case Studies of Emergency Management and Community Policy

COAUTHORS

Gaylord Candler

Professor and MPA Director, University of North Florida
Brazilian "Critical Assimilation" in American Case Studies of Emergency Management and Community Policy

Eunju Rho

Assistant Professor, Northern Illinois University
Am I a Scientist or a Government Employee? The Occupational Identity of Researchers at Korean National Research Institutes

3:45 p.m. - 5:00 p.m.

Rhode Island

KAPA Session—Understanding Public Officials in Korea

Global Public Administration

MODERATOR

Dongwook Kim

KAPA President and Director, Intelligent Society and Policy Research Center, Seoul National University

Panels (continued)

PRESENTERS

Chae-Jeong Lee

Associate Research Fellow, National Assembly Futures Institutes

An Analysis of the Effects of the Government's Characteristics on Life Satisfaction

Sabinne Lee

Postdoctoral Student, Yonsei University
Individual, Organizational Antecedents of Public Service Motivation and Pro-Social Behaviors: A Meta-Analysis about Origin and Differences

PRESENTERS/COAUTHORS

Kyungdong Kim

Doctoral Student, Seoul National University
A Comparison of Predictive and Explanatory Models of Public Officials' Turnover: Is Machine Learning a Promising Solution?

Kilkon Ko

Professor, Seoul National University
A Comparison of Predictive and Explanatory Models of Public Officials' Turnover: Is Machine Learning a Promising Solution?

3:45 p.m. - 5:00 p.m.

New Hampshire

Infrastructure Changes for the Future in the Aftermath of a Major Disaster

Infrastructure

Endorsed By:

Section on Emergency and Crisis Management and Section on Environmental and Natural Resources Administration

MODERATOR/PRESENTER

James Thurmond

Director, MPA Program, University of Houston
Understanding Local Governance Networks Before, During and after an Emergency

PRESENTERS/COAUTHORS

Antoinette Christophe

Professor, Texas Southern University
Hurricane Harvey's Toxic Sewage: A Comparative Study

Xiangnan Hu

Doctoral Student, Xi'an Jiaotong University
Emergency Management Reforms in China: From the Wenchuan Earthquake to the Jiuzhaigou Earthquake

Rizwan Hussain

MPA Student, Texas Southern University
Coping with Damages in the City of Houston in the Aftermath of Harvey

COAUTHORS

Jovita Esechie

Visiting Professor, Texas Southern University
Hurricane Harvey's Toxic Sewage: A Comparative Study

Lynette Howe

Manager, City of Houston
Hurricane Harvey's Toxic Sewage: A Comparative Study

Naim Kapucu

Professor and Director, University of Central Florida
Emergency Management Reforms in China: From the Wenchuan Earthquake to the Jiuzhaigou Earthquake

Sarmistha Majumdar

Associate Professor, Texas Southern University
Coping with Damages in the City of Houston in the Aftermath of Harvey

Huizeng Zhao

Doctoral Student, Xi'an Jiaotong University
Emergency Management Reforms in China: From the Wenchuan Earthquake to the Jiuzhaigou Earthquake

Zhengwei Zhu

Dean, Xi'an Jiaotong University
Emergency Management Reforms in China: From the Wenchuan Earthquake to the Jiuzhaigou Earthquake

3:45 p.m. - 5:00 p.m.

New Jersey

New Theoretical and Methodological Insights from the 2017 Hurricane Season: Transitioning from Relief to Long-Term Recovery

Infrastructure

Endorsed By:

Section on Complexity and Network Studies, Section on Emergency and Crisis Management, Section on Environmental and Natural Resources Administration and Section on Public Administration Research

MODERATOR/PRESENTER

Fatih Demiroz

Assistant Professor, Sam Houston State University
How People Organize on Social Media for Disaster Relief: An Exploratory Analysis of Facebook Data after Hurricane Harvey

Panels *(continued)*

DISCUSSANT

Louise Comfort

Professor, University of Pittsburgh

PRESENTER

Naim Kapucu

Professor and Director, University of Central Florida
Role of Extending, Expanding and Emergent Networks in Response to Hurricanes in Florida

PRESENTERS/COAUTHORS

Brian Gerber

Associate Professor, Arizona State University
Community Unmet Needs and Mass Care Service Delivery Response by the Nonprofit Sector: Performance Evidence from Hurricane Irma in Florida

Thomas Haase

Assistant Professor, Sam Houston State University
From the Christmas Spirit to the Cowboy Café: Unpacking Rural Resilience in Texas after Hurricane Harvey

Omur Damla Kuru

Doctoral Student, Florida International University
Back to “The New Normal” in the Face of Rising Seas: Post-Hurricane Irma Relocation and Repopulation in Monroe County

COAUTHORS

Melanie Gall

Research Professor, Arizona State University
Community Unmet Needs and Mass Care Service Delivery Response by the Nonprofit Sector: Performance Evidence from Hurricane Irma in Florida

Nazife Ganapati

Associate Professor, Florida International University
Back to “The New Normal” in the Face of Rising Seas: Post-Hurricane Irma Relocation and Repopulation in Monroe County

Ashley Ross

Assistant Professor, Texas A&M University—Galveston
From the Christmas Spirit to the Cowboy Café: Unpacking Rural Resilience in Texas after Hurricane Harvey

Wen-Jiun Wang

Assistant Professor, Sam Houston State University
From the Christmas Spirit to the Cowboy Café: Unpacking Rural Resilience in Texas after Hurricane Harvey

3:45 p.m. - 5:00 p.m.

Virginia

Public Branding at the Local Government Level

Infrastructure

Endorsed By:

Section for Women in Public Administration

MODERATOR

Staci Zavattaro

Associate Professor, University of Central Florida

PRESENTERS

Jasper Eshuis

Associate Professor, Erasmus University
The Effects of Multiple Stakeholder Branding and Counterbranding of Public Places

Ulrich Jensen

Assistant Professor, Arizona State University
Getting the Message across: Charismatic Communication Strategies for Effective Social Media Use in Local Government

Danbee Lee

Doctoral Student, Rutgers University—Newark
Do You Buy My Words? The Effectiveness of Federal Agencies' Communication Strategies

Efe Sevin

Assistant Professor, Reinhardt University
Branding in the Shadows? Public Branding and Communication in Exurban Environments

Blair Thomas

Lecturer, University of Central Florida
Managing the Strategic Toolbox: How Florida's Cities Use Branding for Strategic Goals

PRESENTER/COAUTHOR

Darrin Wilson

Assistant Professor, Northern Kentucky University
Civic Pride in the Cocreation and Co-production of Community Branding

COAUTHORS

Elishia Chamberlain

City Administrator, City of Ludlow
Civic Pride in the Cocreation and Co-production of Community Branding

Thomas Elfers

MPA Student, Northern Kentucky University
Civic Pride in the Cocreation and Co-production of Community Branding

Panels *(continued)*

Marsha High

MPA Student, Northern Kentucky University
Civic Pride in the Cocreation and Co-production of Community Branding

James McManus

MPA Student, Northern Kentucky University
Civic Pride in the Cocreation and Co-production of Community Branding

Danielle Ott

MPA Student, Northern Kentucky University
Civic Pride in the Cocreation and Co-production of Community Branding

Ryan Salzman

Associate Professor, Northern Kentucky University
Civic Pride in the Cocreation and Co-production of Community Branding

Taylor Schafer

MPA Student, Northern Kentucky University
Civic Pride in the Cocreation and Co-production of Community Branding

Nikki Williams

MPA Student, Northern Kentucky University
Civic Pride in the Cocreation and Co-production of Community Branding

Jeremy Worley

MPA Student, Northern Kentucky University
Civic Pride in the Cocreation and Co-production of Community Branding

3:45 p.m. - 5:00 p.m.

Maryland

Environmental Federalism and Its Discontents: Environmental and Natural Resource Administration When the Center and the Periphery Disagree

Infrastructure

Endorsed By:

Section for Women in Public Administration, Section on Environmental and Natural Resources Administration and Section on Intergovernmental Administration and Management

PRESENTERS

Sarmistha Majumdar

Associate Professor, Texas Southern University
Environmental Federalism and Its Impacts on Fracking

Shin Kue Ryu

Assistant Professor, Idaho State University
Dancing to Different Tunes: Indonesia's Federalism in the Water Sector

PRESENTERS/COAUTHORS

Rabina Bissessar

Doctoral Student, North Carolina State University
The Impact of Utility Discretion on Residential Solar Requirements

Jonathan M. Fisk

Assistant Professor, Auburn University
Managing Production: Pennsylvania's Oil and Gas Enforcement from 2000-2015

AJ Good

Doctoral Student, Auburn University
Managing Production: Pennsylvania's Oil and Gas Enforcement from 2000-2015

Soren Jordan

Assistant Professor, Auburn University
Managing Production: Pennsylvania's Oil and Gas Enforcement from 2000-2015

Robert Reedy

Program Director, Grid Integration, University of Central Florida
The Impact of Utility Discretion on Residential Solar Requirements

Kelly Stevens

Assistant Professor, University of Central Florida
The Impact of Utility Discretion on Residential Solar Requirements

Yiwei Yu

Graduate Student, Nanjing University
Two Collaborative Modes under One Coordinative Structure: A Case of "Watershed Manager" of China

COAUTHOR

Hong Zhang

Doctoral Student, Lanzhou University
Two Collaborative Modes under One Coordinative Structure: A Case of "Watershed Manager" of China

Panels *(continued)*

3:45 p.m. - 5:00 p.m. South Carolina

Challenges, Initiatives and Insights: Visible and Not So Visible Biases and Barriers to Gender Equity in Public Service

Social Equity

Endorsed By:

Association for Budgeting and Financial Management, Section for Women in Public Administration, Section on Democracy and Social Justice and Section on Ethics and Integrity in Governance

DISCUSSANT/COAUTHOR

Hillary Knepper

Associate Professor and Interim Associate Provost for Academic Affairs, Pace University

Why Is the Research Productivity Gap Still Wide Between Men and Women Public Administration Academics?

PRESENTER

Michelle Evans

Assistant Professor, University of Tennessee—Chattanooga

An Examination of the Nonprofit Sector through a Gendered Lens

PRESENTERS/COAUTHORS

Nicole Elias

Assistant Professor, John Jay College of Criminal Justice, City University of New York

Gender Equity Initiatives in City Government: Discursive Frames and Policy

Gina Scutelnicu

Assistant Professor, Pace University

Why Is the Research Productivity Gap Still Wide Between Men and Women Public Administration Academics?

Shilpa Viswanath

Doctoral Student, Rutgers University—Newark

Gender Responsive Budgeting Research: Insights for Public Administration Research and Praxis

COAUTHORS

Maria D'Agostino

Associate Professor and Chair, Department of Public Management, John Jay College of Criminal Justice, City University of New York

Gender Equity Initiatives in City Government: Discursive Frames and Policy

Helisse Levine

Professor and MPA Director, Long Island University—Brooklyn

Gender Responsive Budgeting Research: Insights for Public Administration Research and Praxis

Meghna Sabharwal

Associate Professor, University of Texas at Dallas

Gender Responsive Budgeting Research: Insights for Public Administration Research and Praxis

Rebecca Tekula

Executive Director, Wilson Center for Social Entrepreneurship and Assistant Professor, Pace University

Why Is the Research Productivity Gap Still Wide Between Men and Women Public Administration Academics?

3:45 p.m. - 5:00 p.m.

New York

Administrative Failures and Social Equity

Social Equity

Endorsed By:

Association for Budgeting and Financial Management, Section for Women in Public Administration, Section on Democracy and Social Justice and Section on Ethics and Integrity in Governance

MODERATOR/DISCUSSANT

Blue Wooldridge

Professor, Virginia Commonwealth University

PRESENTERS

Sebawit Bishu

Assistant Professor, University of Colorado Denver

Traces of Masculine Advantages in Public Institutions

Brandi Blessett

Associate Professor, University of Cincinnati

The Enduring Legacy of Disenfranchisement: Administrative Responsibility and Citizen Engagement

Andrea Headley

Postdoctoral Fellow, University of California—Berkeley
When Race, Poverty and Governmental Fiscal Constraints Intersect

PRESENTER/COAUTHOR

Sara McClellan

Assistant Professor, Sacramento State University

Promise in California: Public Planning as a Means to Improved Police Accountability and Social Equity

Panels *(continued)*

COAUTHOR

Bryon Gustafson

Managing Partner, Org Management Group
Promise in California: Public Planning as a Means to Improved Police Accountability and Social Equity

Networking Events

6:30 p.m. - 7:30 p.m.

See Monday Overview
for Locations

(Open to all attendees)

Brigham Young University Ice Cream Social and Founders' Fellows Reception

National Public Service Awards Reception

CU Denver, UCCS, CSU and Colorado Chapter of ASPA Reception

(RSVP Required)

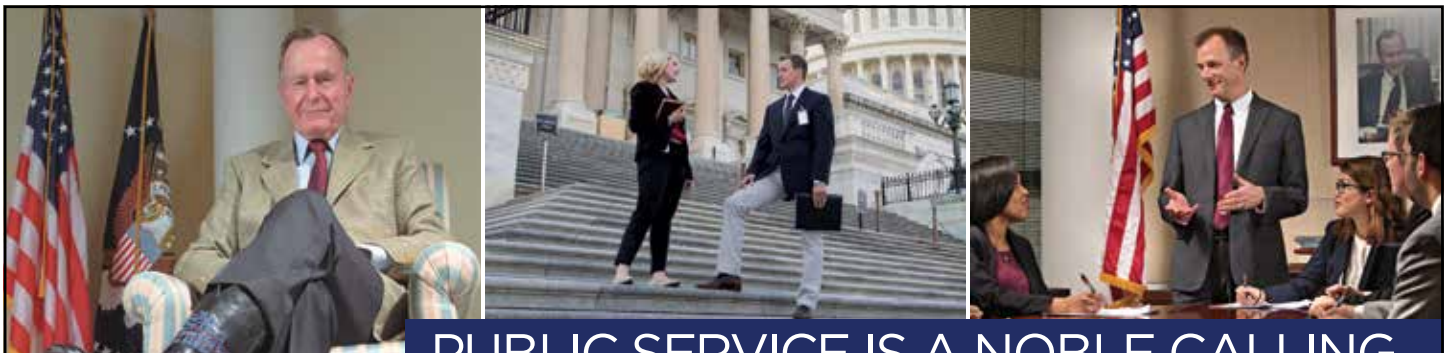

PUBLIC SERVICE IS A NOBLE CALLING

DEGREES

Master of Public Service
and Administration

Master of
International Affairs

Master of
International Policy

Executive Master of Public Service
and Administration (Online)

RESEARCH INSTITUTES, CENTERS, AND PROGRAMS

Institute for Science, Technology and Public Policy
Mosbacher Institute for Trade, Economics, and Public Policy
Scowcroft Institute for International Affairs
Albritton Center for Grand Strategy
Center for Nonprofits and Philanthropy
Cyber Policy, Security, and Strategy Program
Women, Peace, and Security Program

CERTIFICATE PROGRAMS

Advanced International Affairs
Homeland Security
Nonprofit Management
Public Management

FOR MORE INFORMATION:

bush.tamu.edu • 979.862.3469

The
Bush School
OF GOVERNMENT & PUBLIC SERVICE
TEXAS A&M UNIVERSITY 



SAVE THE DATE!



ASPA 2020

ANNUAL CONFERENCE

April 3-7, 2020

Anaheim, California

Hyatt Regency Orange County

TRACKS

Global Public Administration

Infrastructure

Public Finance

Public Service

Social Equity

[#ASPA2019](#)

TUESDAY SESSIONS

31 faculty members. 10 degree programs. 1 new campus.

The UCF School of Public Administration is a premier developer of public servants. Our new location, in the heart of downtown Orlando, allows our students to directly interact with the communities they serve.

We offer the following programs:

- Public Administration
- Nonprofit Management
- Research Administration
- Urban and Regional Planning
- Emergency Management & Homeland Security

#6 Emergency Management 

 **Nonprofit Management #12**



Other Rankings

- Public Finance and Budgeting
- Public Management and Leadership
- Public Policy Analysis
- Best Public Affairs Programs

U.S. News & World Report, 2018

Fall 2019

UCF Downtown Opens

Learn more at ccie.ucf.edu/public-administration



**School of Public
Administration**

UNIVERSITY OF CENTRAL FLORIDA

Tuesday Sessions MARCH 12

TRACKS: ● Public Finance ● Infrastructure ● Social Equity ● Public Service ● Global PA

SESSION	TIME	Room
ASPA Registration Open	7:00 a.m. – 10:30 a.m.	Promenade Foyer
● Presidential Panel—Significant Risks in Higher Education: The Future Is in Our Hands (<i>Public Finance Focus</i>)	8:00 a.m. – 9:15 a.m.	Chinese Ballroom
● Building the Next Generation of Federal Leaders: Developing Leadership for Uncertain Times	8:00 a.m. – 9:15 a.m.	Palm Court
● From Direct Assaults to Malign Neglect: Experts, Policy and Administration in the Era of Trump	8:00 a.m. – 9:15 a.m.	Pennsylvania
● To Serve as a Model Employer: Understanding Federal Employees' Experiences with Discrimination, Harassment and Assault	8:00 a.m. – 9:15 a.m.	Senate
● Network Governance: Theories, Frameworks and Applications	8:00 a.m. – 9:15 a.m.	South Carolina
● Ferrel Heady Roundtable	8:00 a.m. – 9:15 a.m.	East Room
● The Political Dynamics of Administrative Behaviors	8:00 a.m. – 9:15 a.m.	State
● Social Equity Concerns in the Opioid Crisis	8:00 a.m. – 9:15 a.m.	Georgia
● Can Public Interactions and Outreach Affect Equitable Participation and Service Delivery?	8:00 a.m. – 9:15 a.m.	Massachusetts
● Equitable Opportunities for Women in Pay, Promotion, Career and Entrepreneurship Choices	8:00 a.m. – 9:15 a.m.	Rhode Island
● Overcoming "Governance Syndrome" with Theories, Methods, Measures and Case Analyses	9:30 a.m. – 10:45 a.m.	Palm Court
● University of Seoul Session—Seoul's Policies for Urban Management	9:30 a.m. – 10:45 a.m.	South Carolina
● KAPA Session—Understanding Public Officials in Korea: Understanding Policy Behaviors	9:30 a.m. – 10:45 a.m.	New Jersey
● Developing the Next Generation of Public Service Leaders	9:30 a.m. – 10:45 a.m.	Pennsylvania
● Stories Managers Tell: Using Qualitative Inquiries to Improve Public Management Research	9:30 a.m. – 10:45 a.m.	Senate
● The Diverse Perspectives of Resilience and Public Governance	9:30 a.m. – 10:45 a.m.	State
● Understanding Diversity and Differences: Seizing Equity in Education	9:30 a.m. – 10:45 a.m.	Georgia
● Gender and Diversity in the Workplace	9:30 a.m. – 10:45 a.m.	Rhode Island
● Risks and Opportunities as Nonprofits Tackle Social Equity	9:30 a.m. – 10:45 a.m.	Massachusetts
Closing Plenary	11:00 a.m. – 1:00 p.m.	Grand Ballroom

MARCH 12 Tuesday Sessions

TRACKS: ● Public Finance ● Infrastructure ● Social Equity ● Public Service ● Global

Presidential Panel

8:00 a.m. - 9:15 a.m. Chinese Ballroom

Significant Risks in Higher Education: The Future Is in Our Hands

Public Service

MODERATOR

Cynthia Vitters

Risk and Financial Advisory Managing Director, Deloitte & Touche

PRESENTERS

Michael Dean

Chief Risk Officer and Senior Executive Head of Portfolio, Risk and Data, U.S. Department of Education, Federal Student Aid

Luke Figora

Senior Associate Vice President, Chief Risk and Compliance Officer, Northwestern University

Julia Zobel

Assistant Vice President, Safety, Emergency and Enterprise Risk Management, George Mason University

Workshop

8:00 a.m. - 9:15 a.m. Palm Court

Building the Next Generation of Federal Leaders: Developing Leadership for Uncertain Times

Public Service

Endorsed By:

Section for Women in Public Administration

PRESENTERS

David Bray

Executive Director, People-Centered Internet Coalition

Brenda Kole

Assistant Director of Operations, Drake University
Cultivating Talent, Passion and Leadership Skills in Tomorrow's Public Leaders

Allyson Miller

Undergraduate Chief of Staff, Drake University
Cultivating Talent, Passion and Leadership Skills in Tomorrow's Public Leaders

Theresa Whelan

Principal Deputy Assistant Secretary of Defense, Office of the Secretary of Defense

Vicky Wilkins

Dean, American University

Susan Yarwood

Chief, Human Capital and Security, U.S. Secret Service

Panels

8:00 a.m. - 9:15 a.m. Pennsylvania

From Direct Assaults to Malign Neglect: Experts, Policy and Administration in the Era of Trump

Public Service

Endorsed By:

Association for Budgeting and Financial Management and Section on Environmental and Natural Resources Administration

MODERATOR/DISCUSSANT

John Marvel

Assistant Professor, George Mason University

PRESENTERS

James Conant

Professor, George Mason University
Targeting EPA: The Trump Administration's War on Scientific and Administrative Expertise in Environmental Protection

Priscilla Regan

Professor, George Mason University
Algorithmic Decisionmaking and Information Privacy: Who Are the Experts?

Jessica Terman

Assistant Professor, George Mason University
Silencing Administrators: A Constitutional Argument

PRESENTERS/COAUTHORS

Michelle Buehlmann

Doctoral Student, George Mason University
Experts on Top, on Tap or Down the Tubes? The Declining Influence of Expertise in Congressional Policymaking

Panels *(continued)*

Timothy Conlan

Professor, George Mason University
Experts on Top, on Tap or Down the Tubes? The Declining Influence of Expertise in Congressional Policymaking

8:00 a.m. - 9:15 a.m.

Senate

To Serve as a Model Employer: Understanding Federal Employees' Experiences with Discrimination, Harassment and Assault

Public Service

Endorsed By:
Section on Ethics and Integrity in Governance

MODERATOR/COAUTHOR

James Tsugawa

Deputy Director, Policy and Evaluation, U.S. Merit Systems Protection Board
Preventing and Addressing Sexual Harassment in the Federal Workplace

PRESENTERS/COAUTHORS

Rachel Clare

Senior Research Psychologist, Center for Health and Resilience Research, Office of People Analytics, Department of Defense
Assessing Equal Opportunity Organizational Climate in the U.S. Military

Armando Estrada

Assistant Professor, Temple University
Results of the 2017 Work Environment Survey of the National Park Service

Cynthia Ferentinos

Senior Research Analyst, Office of Policy and Evaluation, U.S. Merit Systems Protection Board
Preventing and Addressing Sexual Harassment in the Federal Workplace

Ashlea Klahr

Director, Center for Health and Resilience Research, Office of People Analytics, Office of People Analytics, Department of Defense
Workplace and Gender Relations Research within the Department of Defense

Christine Rush

Associate Professor, Mississippi State University
Characterizing Non-Sexual Harassment: Federal-Sector Experience with the Hidden Form of Workplace Discrimination

COAUTHORS

Rachel Breslin

Senior Applied Social Scientist, Office of People Analytics, Department of Defense
Workplace and Gender Relations Research within the Department of Defense

Ellen Rubin

Associate Professor, University at Albany, The State University of New York
Characterizing Non-Sexual Harassment: Federal-Sector Experience with the Hidden Form of Workplace Discrimination

8:00 a.m. - 9:15 a.m.

South Carolina

Network Governance: Theories, Frameworks and Applications

Public Service

Endorsed By:
Section on Complexity and Network Studies, Section on Intergovernmental Administration and Management and Section on Public Administration Research

PRESENTERS

Younhee Kim

Associate Professor, Penn State Harrisburg
The Price of Citizen Participation in Collaborative Governance

Safiya Prysmakova

Doctoral Student, University of Central Florida
The Use of Network Responsiveness to Client Needs as Whole Network Outcome Measurement

Jeffrey Thorsby

Senior Administrative Analyst, Office of the Board of Supervisors, County of Nevada, California
A Case Study on the Role of Local Governance in Complex Multijurisdictional Networks in Wildfire Mitigation Public Policy

Aaron Wachhaus

Assistant Professor, University of Baltimore
Healthy Partnerships? Assessing Local Health Care Networks: A Comparative Analysis

Panels *(continued)*

PRESENTER/COAUTHOR

Jie Tao

Doctoral Student, University of North Texas
Do Traditional Citizen Participation and E-Participation Make a Difference in Terms of Their Effects on Citizen Satisfaction?

COAUTHOR

Brian Collins

Chair, Associate Professor and MPA Coordinator, University of North Texas
Do Traditional Citizen Participation and E-Participation Make a Difference in Terms of Their Effects on Citizen Satisfaction?

8:00 a.m. - 9:15 a.m.

East Room

Ferrel Heady Roundtable

Global Public Administration

MODERATOR

Raymond Cox

Professor Emeritus, University of Akron

DISCUSSANTS

Demetrios Argyriades

Professor, John Jay College of Criminal Justice, City University of New York

Aroon P. Manoharan

Associate Professor, University of Massachusetts—Boston

Heidi Jane Smith

Professor, Universidad Iberoamericana

George Vernardakis

Professor, Middle Tennessee State University

8:00 a.m. - 9:15 a.m.

State

The Political Dynamics of Administrative Behaviors

Global Public Administration

Endorsed By:

Section on Chinese Public Administration

MODERATOR/COAUTHOR

Liang Ma

Associate Professor, Renmin University of China
With the King Like a Tiger: Explaining the Length of Ministerial Tenure in China

DISCUSSANT/COAUTHOR

Tom Christensen

Professor, University of Oslo
With the King Like a Tiger: Explaining the Length of Ministerial Tenure in China

PRESENTERS

Tianfeng Li

Doctoral Student, Florida State University
Politicization of City Managers and Municipal Performance in China: Testing the Moderating Role of Political Turnover and Competition for Promotion

Daan Wang

Doctoral Student, City University of Hong Kong
Fitting the Person to the Job or to the Organization? Evaluating the Process of Civil Service Selection in Shenzhen Municipality

Nandiyang Zhang

Associate Professor, Renmin University of China
Administrative Levels, Executive Orders and Policy Implementation Deficits: Evidence from China's Administrative Reform

PRESENTERS/COAUTHORS

Sicheng Chen

Postdoctoral Research Fellow, Tsinghua University
With the King Like a Tiger: Explaining the Length of Ministerial Tenure in China

Chenguang Li

Lecturer, Nankai University
A Comparative Analysis on the Urban Transformation in the United Kingdom and China: The Case of Manchester and Hangzhou

Xinze Li

Student, University of Glasgow
A Comparative Analysis on the Urban Transformation in United Kingdom and China: The Case of Manchester and Hangzhou

Panels *(continued)*

8:00 a.m. - 9:15 a.m.

Georgia

Social Equity Concerns in the Opioid Crisis

Social Equity

Endorsed By:

Section on Democracy and Social Justice, Section on Emergency and Crisis Management, Section on Ethics and Integrity in Governance and Section on Health and Human Services Administration

MODERATOR

Shannon Portillo

Assistant Vice Chancellor and Associate Professor, University of Kansas

DISCUSSANT

Rosie Bryant

Community Organizer, Faith in Indiana

PRESENTERS

Kionte Bryant

Community Activist

Moral Panics in the War On Drugs and Sex Trafficking

Morgan Farnworth

Doctoral Student, University of Kansas

To Whom Does Zero Tolerance Apply? Lessons for the Opioid Crisis

Jyleesa Hampton

Doctoral Student, University of Kansas

Why Didn't We See this Coming?! Situating Racialized Policing and Punitive Approaches to Drug Use

Cassandra Osei

Doctoral Student, University of Kansas

Public Health and the Racialization of Addiction

PRESENTERS/COAUTHORS

Amy Cook

Associate Professor, Virginia Commonwealth University
Opioid Use Risk and Protective Factors Among Inmates in a Virginia Jail: Implications for Policy

Nancy Ann Morris

Associate Professor, Virginia Commonwealth University
Opioid Use Risk and Protective Factors Among Inmates in a Virginia Jail: Implications for Policy

8:00 a.m. - 9:15 a.m.

Massachusetts

Can Public Interactions and Outreach Affect Equitable Participation and Service Delivery?

Social Equity

Endorsed By:

Section on Democracy and Social Justice, Section on Ethics and Integrity in Governance and Section on Health and Human Services Administration

PRESENTERS

Ayesha Masood

Assistant Professor, Lahore University of Management Science

Cursed to Care: Care in the Work of Street-Level Bureaucrats

Changgeun Yun

Assistant Professor, Ajou University

Policy Entrepreneurship for Non-Entrepreneurs: The Role of Policy Entrepreneurs in the Adoption of a New Policy

PRESENTERS/COAUTHORS

Seungho An

Assistant Professor, Texas Tech University

Citizen Participation in Public Service Delivery: The Role of Citizen Participation in Promoting Social Equity

Beomgeun Cho

Doctoral Student, University at Albany, The State University of New York

Policy Entrepreneurship for Non-Entrepreneurs: The Role of Policy Entrepreneurs in the Adoption of a New Policy

Abdul Samad

Doctoral Student, Florida International University

Citizen Participation and Marginalized Groups: What Have We Learned about the Participation of Marginalized Groups?

COAUTHORS

Nazife Ganapati

Associate Professor, Florida International University

Citizen Participation and Marginalized Groups: What Have We Learned about the Participation of Marginalized Groups?

Kenneth Meier

Distinguished Scholar in Residence, American University
Citizen Participation in Public Service Delivery: The Role of Citizen Participation in Promoting Social Equity

Panels *(continued)*

8:00 a.m. - 9:15 a.m. Rhode Island

Equitable Opportunities for Women in Pay, Promotion, Career and Entrepreneurship Choices

Social Equity

Endorsed By:

Section for Women in Public Administration, Section on Democracy and Social Justice, Section on Ethics and Integrity in Governance and Students and New Administration Professionals Section

PRESENTERS

Rebecca Reyes

Graduate Student, University of Texas at Dallas
Are Women Leaders Falling Off the Glass Cliff?: The Gendered Nature of Leadership in Local Government

Helen Yu

Assistant Professor, University of Hawaii—Manoa
All Boy's Club? Male Officers' Perceptions of Female Officers' Workplace Experiences in Federal Law Enforcement

PRESENTERS/COAUTHORS

Muge Finkel

Assistant Professor and Co-Director, Gender Inequality Research Lab, GSPIA, University of Pittsburgh
On the Move? How a Lack of Mobility Affects Women's Career Advancement in Danish Public Administration

Caroline Howard Gron

Associate Professor, Crown Prince Frederik Center for Public Leadership, Aarhus University
On the Move? How a Lack of Mobility Affects Women's Career Advancement in Danish Public Administration

Ivan Lee

Doctoral Student, Rutgers University—Newark
Citizens' Perceptions of Closing the Gender Pay Gap: An Experimental Study

JiWon Suh

Assistant Professor, University of Texas at Arlington
The Effect of Perceived Fairness on Female Managers' Perception of Glass Ceiling and Job Satisfaction: A Study Across Sectors

COAUTHORS

Madinah Hamidullah

Associate Research Professor, Rutgers University—Newark
Citizens' Perceptions of Closing the Gender Pay Gap: An Experimental Study

Imane Hijal-Moghrabi

Assistant Professor, University of Texas at Permian Basin
The Effect of Perceived Fairness on Female Managers' Perception of Glass Ceiling and Job Satisfaction: A Study across Sectors

Melanie Hughes

Professor, University of Pittsburgh
On the Move? How a Lack of Mobility Affects Women's Career Advancement in Danish Public Administration

Norma Riccucci

Board of Governors Distinguished Professor, Rutgers University—Newark
Citizens' Perceptions of Closing the Gender Pay Gap: An Experimental Study

Panels

9:30 a.m. - 10:45 a.m. Palm Court

Overcoming "Governance Syndrome" with Theories, Methods, Measures and Case Analyses

Global Public Administration

Endorsed By:

Section for Women in Public Administration, Section on Complexity and Network Studies and Section on Public Administration Research

MODERATOR/COAUTHOR

Jungwon Yeo

Assistant Professor, University of Central Florida
Collaborative Governance, Cliché or Abstruse? The State of Governance Research in Public Administration Since 2010

DISCUSSANT/PRESENTER

Triparna Vasavada

Associate Professor, Pennsylvania State University
Structures and Processes of Collaborative Governance: A Case Study of Community Advisory Boards' Networks for Nurse-Family Partnership Programs in Pennsylvania

Panels *(continued)*

PRESENTERS/COAUTHORS

Ralph Brower

Professor, Florida State University
The Dynamics of Collaborative Network Fragmentation and Sustainability in Rural Coastal Communities

Taeyeon Hwang

Doctoral Student, SungKyunKwan University
Casual Mechanisms of Collaborative Governance: What is Behind the Social Coordination?

Mysungsuk Lee

Professor, SungKyunKwan University
Measuring Collaborative Governance: A Case Study of Social Coordination for Organ Transplantation in South Korea
 and
Collaborative Governance, Cliché or Abstruse? The State of Governance Research in Public Administration Since 2010

Wen-Chi Shie

Doctoral Student, Florida State University
The Dynamics of Collaborative Network Fragmentation and Sustainability in Rural Coastal Communities

Eunsil Yoo

Doctoral Student, Penn State Harrisburg
Structures and Processes of Collaborative Governance: A Case Study of Community Advisory Boards' Networks for Nurse-Family Partnership Programs in Pennsylvania

Jungmo Yoo

Doctoral Student, SungKyunKwan University
Measuring Collaborative Governance: A Case Study of Social Coordination for Organ Transplantation in South Korea

COAUTHORS

Changmook Han

Doctoral Student, SungKyunKwan University
Collaborative Governance, Cliché or Abstruse? The State of Governance Research in Public Administration Since 2010

Mincheol Hong

Doctoral Student, SungKyunKwan University
Measuring Collaborative Governance: A Case Study of Social Coordination for Organ Transplantation in South Korea

Myungseok Lee

Professor, SungKyunKwan University
Casual Mechanisms of Collaborative Governance: What is Behind the Social Coordination?
 and
Measuring Collaborative Governance: A Case Study of Social Coordination for Organ Transplantation in South Korea

Jooyeon Song

Doctoral Student, SungKyunKwan University
Casual Mechanisms of Collaborative Governance: What is Behind the Social Coordination?

9:30 a.m. - 10:45 a.m.

South Carolina

University of Seoul Session—Seoul's Policies for Urban Management

Global Public Administration

Endorsed By:

International Chapter and Section on Science and Technology in Government

CONVENER

Shin Lee

Professor and Director, Master's Program, University of Seoul

CONVENER/DISCUSSANT

Chun Ho Yeom

Professor and Deputy Director, Seoul Case Study Program, University of Seoul

MODERATOR

Thomas O'Toole

Professor and Executive Director, Cornell University

DISCUSSANT

Jonathan Justice

Professor, University of Delaware

PRESENTERS/COAUTHORS

David Bodway

Graduate Student, Portland State University
A Comparative Analysis of Transparent and Efficient Budgeting Processes via E-Government

Joshua Houston

Student, University of Georgia
Electrifying Seoul's City Bus System: A Cost-Benefit Analysis

Panels *(continued)*

Glenn Johnson

Student, University of Texas at Dallas
An Assessment of the Seoul Fire Service through Comparisons with United States Practices

COAUTHORS

Doug Goodman

Professor, University of Texas at Dallas
An Assessment of the Seoul Fire Service through Comparisons with United States Practices

Sun Young Kim

Assistant Professor, University of Georgia
Electrifying Seoul's City Bus System: A Cost-Benefit Analysis

Junghee Lee

Associate Professor, Portland State University
A Comparative Analysis of Transparent and Efficient Budgeting Processes via E-Government

9:30 a.m. - 10:45 a.m.

New Jersey

KAPA Session—Understanding Public Officials in Korea: Understanding Policy Behaviors

Global Public Administration

MODERATOR

Wonhee Lee

KAPA President-Elect, Hankyung University

PRESENTERS/COAUTHORS

Kyunghoon Cho

Professor, Korean National Open University
A Study on the Change of Recognition of Location of Non-Favorable Facilities

Madinah Hamidullah

Associate Research Professor, Rutgers University—Newark
An Analysis of Gender Differences in Public Administration Doctoral Dissertation Research

Jisoo Kim

Associate Research Fellow, Korea Research Institute for Local Administration
A Study on the Change of Recognition of Location of Non-Favorable Facilities

Sunwoo Lee

Professor, Korean National Open University
A Study on the Change of Recognition of Location of Non-Favorable Facilities

Lindsey McDougle

Associate Professor, Rutgers University—Newark
An Analysis of Gender Differences in Public Administration Doctoral Dissertation Research

Claire Jung Ah Yun

Assistant Professor, Kean University
An Analysis of Gender Differences in Public Administration Doctoral Dissertation Research

9:30 a.m. - 10:45 a.m.

Pennsylvania

Developing the Next Generation of Public Service Leaders

Public Service

Endorsed By:

Section for Women in Public Administration, Section on Ethics and Integrity in Governance and Section on Public Administration Education

MODERATOR/DISCUSSANT

Gregg Buckingham

Former Manager, NASA and Lecturer, University of Central Florida

PRESENTERS

Olivia Cook

Doctoral Student, Auburn University
What's the Most Important Skill to Learn?

Brittany Keegan

Doctoral Student, Virginia Commonwealth University
Preparing Students for Client-Centered Service Learning

L. Frances Liddell

Interim Chair (Retired), Associate Professor and Adjunct Professor, Jackson State University
Strategies to Enhance Ethical and Moral Practices for Entry-Level and Future Public Administrators

Tricia Nolfi

Program Director and Assistant Professor II, Rider University
Theory to Practice: Adult Learning Strategies to Promote the Development of Public Leaders

Panels *(continued)*

Nancy Stutts

Associate Professor and Director, Nonprofit Studies,
Virginia Commonwealth University
Public Leadership and Social Equity

9:30 a.m. - 10:45 a.m.

Senate

Stories Managers Tell: Using Qualitative Inquiries to Improve Public Management Research

Public Service

Endorsed By:

Section on Public Law and Administration

MODERATOR

Hon Chan

Professor, City University of Hong Kong

DISCUSSANT

David Rosenbloom

Distinguished Professor, American University and
Chinese Thousand Talents Program Professor, Renmin
University of China

PRESENTERS

Jie Gao

Assistant Professor, National University of Singapore
*Politics, Law and Administrative Discretion: The Case of
Work Safety Regulation in China*

Huishan Yang

Doctoral Student, Virginia Tech
*Public Service Motivation in China: An Inductive
Approach and an Empirical Test*

PRESENTERS/COAUTHORS

Qian Luo

Doctoral Student and Research Associate, The George
Washington University
*Mixed Methods Research in Public Administration and
Public Policy: The State of the Art*

Naon Min

Doctoral Student, Florida State University
Felt Publicness and Its Dimensions: A Grounded Theory

Zoë Thorkildsen

Doctoral Student and Research Scientist, The George
Washington University and CNA
*Mixed Methods Research in Public Administration and
Public Policy: The State of the Art*

Taewon Yoon

Doctoral Student, Florida State University
*What Does Goal Ambiguity Really Mean: A Grounded
Theory*

Kaifeng Yang

Dean and Professor, School of Public Administration and
Policy, Renmin University of China

9:30 a.m. - 10:45 a.m.

State

The Diverse Perspectives of Resilience and Public Governance

Public Service

Endorsed By:

Section on Chinese Public Administration, Section
on Complexity and Network Studies, Section on
Emergency and Crisis Management and Section on Public
Administration Research

MODERATOR/PRESENTER

Chunmeng Lu

Associate Professor and Department Chair, Tunghai
University
*Redefining Economic Resilience in the Era of Public
Governance*

PRESENTER

Chin-Chih Chu

Dean and Professor, Central Police University
*Psychological Resilience and Adversity Overcoming: A
Study on Police*

PRESENTERS/COAUTHORS

Roger Chen

Associate Professor, Chinese Culture University
*Utilizing Social Network Analysis to Explore the
Attributes and Relation of Disaster Collaborative
Decisionmaking: The Case of Taiwan*

Fan-shien Meng

Doctoral Student, Central Police University
*The Roles and Functions of Technology on the Building
of Safe and Resilient Community: The Case of Smart
Policing*

COAUTHORS

Tzung-Shiun Li

Professor and Chairman, Central Police University
*Utilizing Social Network Analysis to Explore the
Attributes and Relation of Disaster Collaborative
Decisionmaking: The Case of Taiwan*

Panels *(continued)*

Hong-Cheng Liu

Chair and Professor, I-Shou University
The Roles and Functions of Technology on the Building of Safe and Resilient Community: The Case of Smart Policing

Chun-yuan Wang

Associate Professor, Central Police University
The Roles and Functions of Technology on the Building of Safe and Resilient Community: The Case of Smart Policing

9:30 a.m. - 10:45 a.m.

Georgia

Understanding Diversity and Differences: Seizing Equity in Education

Social Equity

Endorsed By:

Section for Women in Public Administration, Section on Democracy and Social Justice, Section on Ethics and Integrity in Governance and Students and New Administration Professionals Section

PRESENTER/COAUTHOR

Patricia Alt

Professor Emerita, Towson University
Educational Inequity: A Discussion of Minority Education in the United States

PRESENTERS

Antwain Leach

Assistant Professor, Fisk University
School Boards and Participation: Assessing the Activities of School Board Members and Their Influence on Civic Culture

Jack Underhill

Consultant
Improving Post-Secondary Graduation Results for Low-Income Students

Karen Wallace

Doctor of Philosophy, Walden University
#BlackGirls Matter: The Consequences of Exclusionary Discipline for African American Girls

PRESENTERS/COAUTHORS

Stacy Drudy

Data Center Director, Network of Schools of Public Policy, Affairs, and Administration
NASPAA's Ph.D. Pathways Initiative

Truemenda Green

Project Manager and Doctoral Student, Intervention Associates and Walden University
Educational Inequity: A Discussion of Minority Education in the United States

Cassandra Henson

Assistant Professor, Towson University
Educational Inequity: A Discussion of Minority Education in the United States

David Marshall

Membership Director, Network of Schools of Public Policy, Affairs, and Administration
NASPAA's Ph.D. Pathways Initiative

Najmah Thomas

Professor, University of South Carolina—Beaufort
Stemming Stereotype Threat: Recruitment, Retention and Degree Attainment for Undergraduates from Underrepresented Backgrounds

9:30 a.m. - 10:45 a.m.

Rhode Island

Gender and Diversity in the Workplace

Social Equity

Endorsed By:

Section on Democracy and Social Justice, Section on Ethics and Integrity in Governance and Students and New Administration Professionals Section

PRESENTERS

Pamela Ransom

Associate Professor, Metropolitan College
Challenges and Opportunities in Engendering Monitoring and Evaluation of Environmental Projects

Valeriya Utkina

Senior Lecturer, National Research University Higher School of Economics
Gender Segregation in the Workplace of Russian Civil Service

PRESENTERS/COAUTHORS

Zhongnan Jiang

Doctoral Student, Ohio State University
Mitigating the Unintended Effects of Diversity in Public Organizations: Can We Make People Like Each Other?

Panels *(continued)*

Shannon Portillo

Assistant Vice Chancellor and Associate Professor,
University of Kansas
Gender Integration in Special Forces: An Exploration of Coded Language as a Form of Institutional Resistance to Change

Beth Rauhaus

Assistant Professor and MPA Graduate Coordinator,
Texas A&M University—Corpus Christi
The Invisible Challenges: Gender Differences Among Public Administration Faculty

Isla Schuchs Carr

Assistant Professor, Texas A&M University—Corpus Christi
The Invisible Challenges: Gender Differences Among Public Administration Faculty

COAUTHORS

Leisha DeHart-Davis

Associate Professor, University of North Carolina
Mitigating the Unintended Effects of Diversity in Public Organizations: Can We Make People Like Each Other?

Alesha Doan

Associate Professor, University of Kansas
Gender Integration in Special Forces: An Exploration of Coded Language as a Form of Institutional Resistance to Change

Shahidul Hassan

Associate Professor, Ohio State University
Mitigating the Unintended Effects of Diversity in Public Organizations: Can We Make People Like Each Other?

9:30 a.m. - 10:45 a.m.

Massachusetts

Risks and Opportunities as Nonprofits Tackle Social Equity

Social Equity

Endorsed By:

Section on Democracy and Social Justice and Section on Ethics and Integrity in Governance

PRESENTER

Yali Pang

Doctoral Student, Virginia Commonwealth University
Gender Equity Implications of Nonprofit Youth Programs: A Case Study of Three African American-Led Nonprofits

PRESENTERS/COAUTHORS

Lauren Azevedo

Assistant Professor, Pennsylvania State University
Community Foundation Board Representation and the Impact on Funding LGBTQ+

Robert Forbis

Assistant Professor, Texas Tech University
Nonprofits as Agents of Social Change: The Role of Community-Based Organizations in Advancing Environmental Policies

Tia Sheree Gaynor

Assistant Professor, University of Cincinnati
Community Foundation Board Representation and the Impact on Funding LGBTQ+

Mirae Kim

Assistant Professor, Georgia State University
Welcoming America Network: Testing Competing Theories of Nonprofit-Government Relationships

Nathaniel Wright

Assistant Professor, Texas Tech University
Nonprofits as Agents of Social Change: The Role of Community-Based Organizations in Advancing Environmental Policies

COAUTHOR

Cathy Yang Liu

Associate Professor, Georgia State University
Welcoming America Network: Testing Competing Theories of Nonprofit-Government Relationships

Closing Plenary

11:00 a.m. - 1:00 p.m.

Grand Ballroom

SPEAKER

Vice President Joseph R. Biden, Jr.

Former Vice President of the United States

College of Public Affairs and Administration

The College of Public Affairs and Administration is dedicated to the belief that effective public affairs education, significant public affairs scholarship, and active service to the community will improve government and public policy in Illinois, the nation and the world.

CPAA is pleased to welcome Dr. Kenneth Kriz to our faculty as a Distinguished Professor of Public Administration. Dr. Kriz is a nationally-recognized scholar in the field of Public Finance, with areas of research in municipal debt policy and management, public pension fund management, public financial risk management, and economic development finance. Dr. Kriz has consulted with several states, cities, and nonprofit organizations, and has served on the board of trustees for numerous pension funds. Dr. Kriz has published more than 40 peer-reviewed academic journal articles and book chapters, has published a textbook on quantitative methods, edited a forthcoming book on tax increment finance, and been a Fulbright Scholar and Fulbright Senior Specialist. Dr. Kriz is looking forward to joining the CPAA faculty, which has strong record of academic achievement in Public Finance.



Degrees and Programs

Doctorate Degree

- Public Administration, DPA

Graduate Degrees

- Environmental Studies, MA and MS
- Legal Studies, MA
- Political Science, MA
- Public Administration, MPA *
- Public Affairs Reporting, MA
- Public Health, MPH

* NASPAA accredited program

Online Graduate Degrees

- Environmental Studies; MA and MS
- Legal Studies; MA
- Political Science; MA
- Public Administration; MPA
- Public Health with Concentration in Environmental Health; MPH

Graduate Certificates

- Community Health Education
- Community Planning
- Emergency Preparedness and Homeland Security
- Environmental Health
- Environmental Risk Assessment
- Epidemiology
- Geographic Information Systems
- Management of Nonprofit Organizations
- Practical Politics
- Public Sector Labor Relations

Undergraduate Degrees

- Criminology & Criminal Justice
- Environmental Studies
- Global Studies
- Legal Studies
- Political Science
- Public Administration
- Public Policy



ASPA thanks our volunteer leadership for its contributions to the Annual Conference. Without you, this event would not have been possible. Your dedication and commitment enables ASPA to advance its mission every day.

Conference Content Leads

Global Public Administration

Rich Callahan
Marilyn Rubin

Infrastructure

John Kirlin
Wendy Haynes

Public Finance

Judy England-Joseph

Public Service

Judy England-Joseph

Social Equity

Susan T. Gooden
Charles E. Menifield

Track Reviewers

Michael Ahn
Ines Beecher
Erin Borry
Marc Holzer
Chryshanna Jackson
Shayne Kavanagh
Carla Kimbrough
Claire Knox
Salta Liebert
Elaine Yi Lu
Sharon Mastracci
Chad Miller
John Pearson
Andrew Podger
Grant Rissler
Randi Kay Stephens
Bryan Sullivan

ASPA National Office

Garret Bonosky
La Shawn Boston
Phillip Carlisle
Karen E. T. Garrett
LaVonda Humphries
Amy Omang
William Shields, Jr.
Asmait Tewelde
Patricia Yearwood

ADVERTISERS

American University, School of Public Affairs	Inside Cover
Arizona State University, School of Public Affairs	104
California State University—San Bernardino	215
<i>City on the Line</i>	157
Cleveland State University, Maxine Goodman Levin College of Urban Affairs	131
Doyle Printing	67
Florida International University	44
George Mason University, Schar School of Policy and Government	158
The George Washington University, Trachtenberg School of Public Affairs	Friday Session Tab
Indiana University, School of Public and Environmental Affairs	35
John Jay College of Criminal Justice, City University of New York	74
New York University, Wagner Graduate School of Public Service	216
Ohio State University, John Glenn School of Public Affairs	69
Portland State University, Hatfield School of Government	24
Routledge	4
Rutgers University—Newark, School of Public Affairs and Administration	Back Cover
Sage Publishing	62
Section on Personnel Administration and Labor Relations (SPALR)	73
Syracuse University, Maxwell School of Citizenship and Public Relations	27
Tarleton State University	66
Texas A&M University, Bush School of Government and Public Service	191
Texas Southern University, Barbara Jordan-Mickey Leland School of Public Affairs	12
University of Central Florida, School of Public Administration	Tuesday Session Tab
University of Delaware, Biden School of Public Policy and Administration	Special Events and Activities Tab
University of Georgia	Saturday Session Tab
University of Houston	132
University of Illinois—Springfield	204
University of Kansas, School of Public Affairs and Administration	11
University of Minnesota, Humphrey School of Public Affairs	14
University of Missouri—Columbia, Harry S Truman School of Public Affairs	Plenaries and Lectures Tab
University of Nebraska at Omaha	36
University of North Carolina—Chapel Hill	103
University of Pittsburgh, Graduate School of Public and International Affairs	Monday Session Tab
University of Southern California, Sol Price School of Public Policy	Sunday Session Tab
Valdosta State University	61
Virginia Commonwealth University, L. Douglas Wilder School of Public Affairs	Inside Back Cover

PRESENTER DIRECTORY

Khaldoun AbouAssi	183	Angela Bailey	184	Ann Braga	173, 181
Romeo Abraham	125, 135	Margo Bailey	140	Lori Brainard	166
Osama Abufarraj	83	Alikhan Baimenov	96, 130	David Bray	194
Sawsan Abutabenjeh	92, 102	HyeonUk Bak	170	Christine Brenner	168
Jason Ackleson	145	Guoxian Bao	146	Rachel Breslin	195
Issifu Adulai Amadu	83	Haixu Bao	146	Alex Brillantes, Jr.	143
Whitney Afonso	163	Katherine Barrett	149	Tanya Brinkley	79
Vishakha Agarwal	171	John Bartle	118, 146	Paul Broussard	178
Saman Aghaebrahim	142	Rumki Basu	87	Ralph Brower	119, 199
Juan Pablo Aguirre Quezada	145	Lyndsay Bates	175	Alex Brown	94
Anna Ahlers	165	Peter Batsa	115	Curtis Brown	149, 153
Michael Ahn	120, 162, 171, 180	Daniel Bauer	93	Dustin Brown	184
Shama Akhtar	166	Michael W. Bauer	85	Samuel Brown	167
Mohamed Alaa Abdel-Moneim	81	Natalie Bauer	176	Trevor Brown	102
Austin Aldag	89, 126	Zachary Bauer	184	James Brunet	99
Chad Aldeman	95	Cory Baumhardt	94	Kionte Bryant	197
Diana Al-Fayez	135	Brian Beachkofski	98	Rosie Bryant	197
Ahmed Al-Wani	82	Abigail Beatty	129	Thomas Bryer	168
Susannah Ali	92, 119	Talia Beaulieu-Hains	185	Gregg Buckingham	100, 200
Haris Alibasic	89, 126	Richard Beck	113	Neal Buckwalter	186
Mohamad Alkadry	92	Michael Bednarczuk	107	Michelle Buehlmann	194
Mohammed Alkhourayyif	136, 178	David Bell	108	Justin Bullock	130
Saad Alkhourayyif	136, 179	Ricardo Bello-Gomez	82	Mallory Bulman	91, 99
Laura Allen	120	Abraham Benavides	87, 136	Brendan Burke	119
Marie Alonzo	176	Evan Berman	139	Christopher Burks	97
Saud Alotoaibij	92	Frances Berry	97, 113	Sylvia M. Burwell	169
Emma Alpert	183	RaJade Berry-James	140, 167, 169	Edgar Bustos	169
Patricia Alt	175, 202	Karabi Bezboruah	174	Cathleen Buzan	129
Samantha Amazan	171	Soumya Bhat	167	Theodore Byrne	112
Anna Amirkhanyan	129	Joseph R. Biden, Jr.	203	Zeshan Cai	78
Seongho An	77, 197	Raed Bin Shams	93	Rich Callahan	114
Jason Anastasopoulos	182	Sebawit Bishu	89, 190	Crystal Calarusse	128
Staffan Andersson	138	Carin Bisland	161	Hannah Cameron	149
Simon Andrew	95, 137, 179	Rabina Bissessar	189	Susan Camilleri	79
Frank Anecharico	138	Adam Blair	180	Anthony Campbell	179
Lachezar Anguelov	90, 93, 126	Anita Blair	143	Karolyn Campbell	183
Taryn Anthony	142	J. Paul Blake	81, 107, 142, 149, 169	Kevin Campbell	148
Meril Antony	185	Robert Bland	101	Gaylord Candler	186
David Arellano-Gault	141	Brandi Blessett	126, 130, 142, 155, 182, 190	Xianqiang Cao	116
Demetrios Argyriades	130, 196	Simpson Boateng	115	David Capelli	161
Karina Arias	95	Candice Bodkin	112	Jered Car	91
Maria Aristigueta	94	David Bodway	199	Julia Carboni	130
Hugo Asencio	112	Lyn Boswell	183	Tony Carrizales	144
Shena Ashley	85	Laurent Bouchard	166	John Carroll	128
Emrah Atar	83	Geert Bouckaert	150	Daniel Castro	110
Claudia Avellaneda	82	Heather Boushey	94	Atta Cessay	82
Pallavi Awasthi	87, 125	Sharon Bowen	101	Guorong Chai	174
Tayfun Ayazma	99	James Bowman	139	Paul Chalekian	123
Lauren Azevedo	179, 203	Aaron Boyd	97	Elishia Chamberlain	188
Aisha Azhar	88	Emily Boykin	93	Hon Chan	137, 201
Shahinshah Azim	111	Kimberly Bracey	183	Nittam Chandel	148
Matt Bagwell	98			Kaiju Chang	147

PRESENTER DIRECTORY

Ssu-Ming Chang	177	Roddrick Colvin	143	Stephanie Dolamore	166
Yves Chappoz	166	Louise Comfort	174, 177, 188	Jiaming Dong	177
Matthew Chase	124	James Conant	194	Wenlan Dong	116
Jacqueline Chattopadhyay	183	Stephen Condrey	122, 130, 145	Xinyu Dong	150, 164
Ariane Chebel D'Apollonia	126	Timothy Conlan	195	Philippe Dorbaire	166
Daniele Checchi	86	Amy Cook	197	David Dornisch	153
Bin Chen	165	Brian Cook	125, 138	Rashida Dorsey	140
Can Chen	146, 163	Olivia Cook	200	Nakeina Douglas-Glenn	142
Jiandong Chen	78	Terry Cooper	125	Mortimer Downey	130
Jingan Chen	170	David Copeland	101	Karla Drenner	154
Li-jun Chen	162	Guadalupe Correa-Cabrera	145	Scott Drexler	118, 173
Roger Chen	201	Mauricio Covarrubias	144	Stacy Drudy	202
Shi Chen	170	Michelle Covi	152	Ida Drury	96
Sicheng Chen	196	Raymond Cox	86, 101, 196	Melvin Dubnick	123, 186
Wendy Chen	97	Wesley Crichlow	156	Georgette Dumont	163, 171
Ximeng Chen	111	Andrew Crosby	123	Pamela Dunning	100
Yu-Che Chen	80, 163	Peter Cruise	120	Nicole DuPuis	153
Zitao Chen	164	Selene Cruz	87	Timothy Durham	164
Kuo-Tai Cheng	174	Vivian Cueto	180	Suparna Dutta	82, 97
Li Cheng	128	Maria D'Agostino	184, 190	Adam Eckerd	154
Shaoming Cheng	170	Carl Dahlstrom	84	Steffen Eckhard	85
Yuan (Daniel) Cheng	113	Neil Danberg	117	Mariglynn Edlins	166
Dan Chenok	100	Paul Danczyk	107	Frannie Edwards	154
Bradley Chilton	118	Tane Danger	143	Lauren Edwards	175
Asiyati Lorraine Chiweza	185	Joseph Darmoe	115	Vickie Edwards	181
Beomgeun Cho	84, 197	Jourdan Davis	129	Jörn Ege	85
Ki Woong Cho	148	Dovie Dawson	101	Deborah Eichhorn	81
Kyunghoon Cho	200	Renzo de la Riva Aguero	88	Thomas Elfers	188
Minhyuk Cho	108	Celso De Souza	108	Nicole Elias	126, 156, 169, 190
Donwe Choi	97, 107, 113, 180	Michael Dean	194	Abu Elias Sarkar	83
Eunmi Choi	128	Pandit Deendayal	85	Rachel Emas	98, 100
Iseul Choi	171	Aaron Deslatte	90	Melissa Emerson	110
NakHyeok Choi	110	John Decker	102	Christopher Emrich	147
Yongjin Choi	180	Leisha DeHart-Davis	203	Walter English	153
Rashmi Chordiya	80, 87, 126, 139	Megan DeMasters	152	Adrian Ermurachi	130
Meng-Hsuan Chou	85, 86	Mehmet Demircioglu	84	Jovita Esechie	187
Tom Christensen	137, 196	Fatih Demiroz	187	Jasper Eshuis	100, 188
Cary Christian	110	Kathryn Denhardt	141	Robert Eskridge	112
Antoinette Christophe	187	Dwight Denison	124	Roberto Moreno Espinosa	144
Chin-Chih Chu	201	Michelle (Charles) Dennis	186	Tammy Esteves	100
David Chu	130	Michael D'Italia	156	Armando Estrada	195
Mengran Chu	137	Liya Di	151	Amelia Estwick	135
Wonjun Chung	177	Lisa Dicke	156	Jae Ho Eun	108
Beverly Cigler	94	Jeffrey Diebold	99	Nathan Eva	122
Rachel Clare	195	Schnequa Diggs	125	Angela Evans	184
Charles M. Clark	97	Lisa Dillard	172	Lindsey Evans	80, 168
Eric Click	110	Ana-Maria Dimand	93	Michelle Evans	190
Galia Cohen	182	Taiping Ding	164, 173	Andrew Ewoh	79
Nissim Cohen	99	Casey Dinges	176	Patrick Exmeyer	139
Brian Collins	136, 196	Suzanne Discenza	110	Joseph Fahrney	155
Kathy Colville	79	Alesha Doan	202	Matthew Fairholm	118

PRESENTER DIRECTORY

Fengchun Fan	177	Adela Ghadimi	118	SeungHoon Han	183
Ali Farazmand	85, 121, 130, 154	J. Ramon Gil-Garcia	77, 171	Xu Han	114
Morgan Farnworth	197	Sarah Gilliland	167	Yanbing Han	171
Naya Farrell	79	Jillian Girard	167	Akhlaque Haque	163
Peter Federman	148	Klaus H. Goetz	85	M. Shamsul Haque	81, 83, 86
Mary Feeney	182	AJ Good	90, 189	James Harrington	119, 145
Richard Feiock	91, 98, 174	Susan T. Gooden	130, 149, 161, 184	G.L.A. Harris	155
Alice Feldesman	148	Paul Goodfellow	112	Nathaniel Harris Graham	90
Andrew Feldman	91	Doug Goodman	200	Latika Hartmann	102
Daniel Feldman	141	Amanda Goolden	154	Peter Haruna	78, 87
Vanessa Fenley	183	Robert Goldenkoff	184	Mohamed Hasan Al Sabba	93
Cynthia Ferentinos	195	Jocelyn Gordon	155	Shahidul Hassan	203
Xavier Fernández-i-Marín	85	Lori Gordon	125	William Hatcher	155
Luke Figora	194	Pllar Gorordo	114	Alex Hathaway	102, 109
Hruza Filip	84	John Grathwol	154	Brie Haupt	179
Muge Finkel	198	Garret Graves	94	Stephanie Hawke	144
Jonathan M. Fisk	90, 189	Donna Greco	169	Christopher Hawkins	178
Casey Fleming	112	Truemenda Green	202	Michael Hayes	79
B.J. Fletcher	99	Sherri Greenberg	171	Wendy Haynes	135, 176
Colin Foard	154	Celeste Greene	144	Josephine Hazelton	180
Camila Fonseca	172	Richard Greene	149	Lanping He	151
Albert E. Fontenot, Jr.	184	Heron Greenesmith	141	Wensheng He	78, 174
Robert Forbis	203	Thomas Greitens	123	Andrea Headley	190
John Ford	176	Michael Grewe	143	Nuri Heckler	80, 155, 169
Michael Ford	113	Rick Grimm	93, 138	Roy Heidelberg	153
James Foreman	155	George Grob	95	Megan Heim-LaFrombois	90
Luke Fowler	152	Caroline Howard Gron	198	Alexander Henderson	80, 139
Ashley Fox	181	Denis Guimarães	116	Brandye Hendrickson	176
Howard Frank	110	Chao Guo	77	Cassandra Henson	202
Lora Frecks	125	Chuanyi Guo	124	Neil Hernandez	168
Elizabeth Fredericksen	152	David Hai Guo	78, 110	Emmy Hicks	169
Sara Friedman	167	Jinyun Guo	164	Marsha High	189
Liping Fu	151	Shengli Guo	165	Morgan Higman	178
Marc Fudge	101	Xuesong Guo	82, 137	Imane Hijal-Moghrabi	123, 140, 198
Ludmila Gajdosova	96, 130	Yue Guo	147	Sean Hildebrand	161
Christopher Galik	152	Bryon Gustafson	191	W. Bartley Hildreth	109
Melanie Gall	188	Mary Guy	88, 149, 176	Christopher Hill	156
Samuel Gallaher	148	Hyesong Ha	84	Hunter Hill	98
Nazife Ganapati	177, 188, 197	Thomas Haase	188	Thelma Hite-Harris	143
Sukumar Ganapati	77	Merl Hackbart	109	Trang Hoang	124
Stefan Gänzle	85	Joseph Hafer	99	Mary Jo Hoeksema	184
Jie Gao	137, 201	Yvonne Haigh	84, 143	Katherine Hoffman	144
Xian Gao	163	Jeremy Hall	118, 138	A. Bryce Hoflund	98
Xiang Gao	162	Madinah Hamidullah	198, 200	Kristina Hoghova	108
Jean-Claude Garcia-Zamor	88, 126	Stephen Hamill	99	Maja Holmes	175
Mary Gattis	161	Heather Hamilton	128	Sarah Holmes	95
Tia Sheree Gaynor	126, 182, 203	Roger Hamlin	96	Marc Holzer	77, 115, 164
Beth Gazley	113	Jyleesa Hampton	197	George Homsy	152
Brian Gerber	188	Ahreum Han	79	Mincheol Hong	199
Teresa Gerton	124	Changmook Han	199	Quan-Jing Hong	122
Heather Getha-Taylor	148, 182	Jeehee Han	170	Sophia Hong	128

PRESENTER DIRECTORY

Sounman Hong	181	So Hee Jeon	139, 174	Adrian Kay	86
Yichen Hong	128	Young-hwan Jeon	137, 161	Brittany Keegan	142, 200
Jennifer Hooker	144	Bok Jeong	93	Robin Kempf	129
Stephanie Hoopes	94	Jihoon Jeong	119	Daniel Kenealy	108
Catherine Horiuchi	154	Sol Jeong	162	Alexis Kennedy	183
Farhad Hossain	82, 83, 88, 140	Alessandra Jerolleman	147	Donald Kettl	121
Yilin Hou	118	Yating Jiang	174	Odkhuu Kh.	84
Richard Hough	125	Ying Jiang	102	Namhoon Ki	91
Sam Houghteling	90	Zhongnan Jiang	202	John Kiefer	147, 154
Joshua Houston	199	Mi Jianing	122	Masao Kikuchi	177
Lynette Howe	187	Myung Jin	96, 170	B. Joon Kim	177, 180
Chih-Wei Hsieh	89	Zeyu Jin	78	Dohyeong Kim	148
Jun Yi Hsieh	122	Ning Jing	115	Dongwook Kim	186
Li-Yi Hsu	174	Wu Jing	177	Hanbit Kim	84
Qian Hu	148	Yijia Jing	88	Hwayeon Kim	108
Xiangnan Hu	83, 187	Ernita Joaquin	124	Hyun Joon Kim	114
Xinli Hu	145	Morgen Johansen	143	Jisang Kim	185
Biao Huang	123	Brad Johnson	102	Jisoo Kim	200
Chao Huang	177	Glenn Johnson	200	Koomin Kim	77
Irving Huang	146	Lin Johnson	117	Kyungdong Kim	187
Kun Huang	116, 122	Per Johnson	110	Kyungmin Kim	181
Qing Huang	170	Richard Johnson	141, 155	Kyungwoo Kim	95
Leo Huberts	138, 141, 185	Jocelyn Johnston	184	Mingil Kim	108
Victor Hugg	91	John Jones	99	Minhee Kim	101
Melanie Hughes	198	Soren Jordan	90, 189	Minjung Kim	108
Holly Hull Miori	145	Philip Joyce	149	Mirae Kim	203
Nicole Humphrey	125	Dongjae Jung	108, 175	Na Yeon Kim	114
Hyungjo Hur	174	Juyong Jung	186	Pan Suk Kim	131
Hyunkang Hur	139	Kwangho Jung	122	Soojin Kim	170
David Huron	166	Kyujin Jung	148, 179	Soonee Kim	85
Rizwan Hussain	187	Veronica Junjan	84, 88, 163	Soonhee Kim	111
Taeyeon Hwang	199	Carole Jurkiewicz	125, 141, 182	Soyoung Kim	91
Diana-Camelia Iancu	88, 96	Jonathan Justice	123, 167, 199	Sun Hee Kim	114
Hyesu Im	162	Bridgit Kabah	83	Sun Young Kim	185, 200
Tobin Im	109	Syeda Lasna Kabir	112	Taehyung Kim	84
Gayoung Imm	181	Rym Kaki	78	Yoonho Kim	113
Kathleen Immordino	184	Vaiva Kalesnikaite	77	Younhee Kim	162, 171, 180, 195
Imoh Imoh-Ita	135	Kalu Kalu	93	Yun Kwon Kim	108
Aiden Irish	175	John Kamensky	125, 149	Yusun Kim	118
Kazuyuki Ishida	93	David Kanaan	118	John Kincaid	91
Benoy Jacob	89, 91	Ki Eun Kang	152	Stephen King	118
Jahi Jahija	130	Minsung Michael Kang	185	John Kirlin	161
Ishtiaq Jamil	112	Ning Kang	87, 139	Ashlea Klahr	195
David Jancsics	116, 163	Seong Kang	99	William Klay	117
Saltanat Janenova	88, 96, 131	Sinah Kang	181	Mary Klein	178
Hee Soun Jang	119	Youngwoong Kang	144	Angela Kline	166, 168
Sungkyu Jang	110	Naim Kapucu	82, 83, 137, 148, 174, 187, 188	Donald Klingner	144
Yong Suk Jang	162	Eric Katz	97	Hillary Knepper	175, 190
Wilma Jansen	116	Juniper Katz	99	Jack Knott	142
Stéphane Jean	114	Shayne Kavanagh	120	Claire Knox	147, 154
Ulrich Jensen	188			Kilkon Ko	86, 187

PRESENTER DIRECTORY

Kouliga Koala	92	Jun Ki Lee	117	Jared Llorens	154
Nina Kolabashkina	89	Jung Wook Lee	180	Vanessa Lopez-Littleton	175
Brenda Kole	194	Junghee Lee	200	Chunmeng Lu	201
Christopher Koliba	153, 174	Junghyae Lee	173	Elaine Yi Lu	114, 137, 173
Aleksey Kolpakov	153	Keon Hyung Lee	80, 180	Jiahuan Lu	92, 124, 164
Sara Konrath	81	Minho Lee	109	Xiaojun Lu	88
Stan Korotchenko	163	Mysunguk Lee	199	Yana Lu	119
Rachel Krause	178	Sabinne Lee	187	John Lubin	91
Jessica Kritz	115	Seulki Lee	170	Makysova Lucia	84
Ella Krivitchenko	117	Seung Jong Lee	144	Jacqueline Luedtke	180
Kenneth Kriz	127	Seunghui Lee	181	Juan Lugo	147
Mark Kroeker	114	Shin Lee	199	Luis Luna-Reyes	77
Skip Krueger	118	Sunwoo Lee	200	Qian Luo	201
Dolores Kuchina-Musina	102	Taejun Lee	117	Becky Lutte	179
Ashley Kuenneke	175	Wonhee Lee	200	Cynthia Lynch	98, 120
Nadja S. Kühn	85	Wonkang Lee	94	Thomas Lynch	120
Anthony S. Kumasey	83	J. Peter Leeds	176	Beth Lynk	184
Mingfeng Kuo	163, 173, 177	Robin Lemaire	121	Hyeon Suk Lyu	109
Volodymyr Kuprii	131	Megan LePere-Schloop	182	Ben Ma	152
Omur Damla Kuru	188	Erick LeRoux	166	Jie Ma	165
Rita Kusi	115	Helisse Levine	101, 184, 190	Liang Ma	114, 171, 196
Chang-Gyu Kwak	172	Chenguang Li	123, 196	Xiang Ma	146
Myungjung Kwon	162	Huafang Li	113, 151	Vincent Mabillard	100
Sung-Wook Kwon	172	Hui Li	127	Michael Macaulay	141
Chantelle Lafontant	113	Ling Li	151	Dave Mader	94, 130
Paul Lagunes	116, 163	Qian Li	109	Zach Mahafza	178
Harry Lambright	85	Shijun Li	145	Sarmistha Majumdar	187, 189
Meeyoung Lamothe	112	Tianfeng Li	196	Nadeen Makhoulouf	81
Karen Landale	102	Tzung-Shiun Li	201	Aminu Mamman	83, 88, 140
David Landsbergen	154	Xinze Li	196	Barsha Manandhar	177
Mei Lang	146, 173	Yan Li	137	Aroon P. Manoharan	77, 86, 87, 178, 196
Jennifer Lanterman	153	Zhichao Li	121	Paul Manson	128, 178
Jennica Larrison	127	Jiagi Liang	114	Qingduo Mao	152
Sarah Larson	124	Xuefeng Liang	109	David Marshall	202
Einat Lavee	166	Yuguo Liao	140	James Davis-Martin	161
D.J. LaVoy	94	Benjamin Licht	129	Simone Martin	168
Antwain Leach	202	L. Frances Liddell	200	Thomas Martin	101
Kirk Leach	155	Saltanat Liebert	80, 127	Victoria Martin-Nammour	150
Deborah LeBlanc	140	Paul C. Light	142	Jennifer Martinez	97
Hannah Lebovits	155	Hyunwoo Lim	95, 137	Jerry Martinez	185
Chae-Jeong Lee	187	Kuotsai Liou	122, 145	John Marvel	194
Daewoong Lee	136, 179	Carl Lipo	111	Kevin Mason	100
Danbee Lee	188	Bingsheng Liu	151	Ayesha Masood	197
DoSuk Lee	108	Cathy Yang Liu	150, 203	Adam Masters	141, 186
Hakyeon Lee	124	H. T. Liu	174	Sharon Mastracci	89, 176
Hyun Jung Lee	88	Hong Liu	164	Mathew Mathews	143
In Won Lee	170	Hong-Cheng Liu	202	Paola Mattei	86
Ivan Lee	198	Huaxing Liu	170	Sara Mattingly-Jordan	143
Jaeyong Lee	96	Shiwei Liu	116	Marcus Mauldin	97
Jong Youl Lee	178	Shuhua Monica Liu	84	Joseph Maya Rodriguez	169
Jooho Lee	111, 169	Yinxi Liu	78	Carla Mays	161
Juliet Lee	173	Panayiotis Liverakos	130	Voris McBurnette	140

PRESENTER DIRECTORY

Sean McCandless	80, 126, 141	Shannon Morrison	180	Amanda Olejarski	81
John McCaskill	145	Ricardo Morse	181	Johabed Olvera	83
Sara McClellan	190	Donald Moynihan	149	Ray Oman	95
Clifford McCue	93	Tom Mroz	102	Petra Ophoff	90, 126
Ryan McDonagh	163	Yapikachi Msiska	185	Bianca Ortiz-Wythe	171
Bruce McDonald	101, 138	Rui Mu	137	Cassandra Osei	197
Lindsey McDougle	138, 200	Jeremiah Muhammad	178	Sonia Ospina	170
Kenyan McDuffie	101	Edin Mujkic	112	Thomas O'Toole	199
Laurel McFarland	124	Kamila Mukhamedhanova	89	Danielle Ott	189
Kate McGovern	96	Lauren Bock Mullins	120	J. Steven Ott	107
Megan McGuffey	99	Terry Murphy	139	Ron Ottem	172
Katherine McIntire Peters	97	Kyle Murray	100	Paula Overby	141
Lauren McKeague	121	Jennifer Murtazashvili	89	Elizabeth Overman	155
James McManus	189	Assel Mussagulova	150	Michael Overton	101
Marcia McNutt	124	Tina Nabatchi	130, 181	Amy Owen	150
Alejandra Medina	99	Ahmad Nader Nadery	131	Angela Paez	168
Pamela Medina	88	Irene Nafisatu Okhade	83	Henadzi Palchyk	131
Kenneth Meier	129, 197	Brian Nakamura	186	Lakshmi Pandey	102
James Melitski	144, 178	Jiwon Nam	112	Yali Pang	203
Maggie Mello	143	Taewoo Nam	186	Liting Panv	84
Fan-shien Meng	201	Ilham Nasser	82	Alina Parbtani	92, 181
Fanrong Meng	164	Lorenda Naylor	141	Chul Hyun Park	77
Charles E. Menifield	141, 169	Tonya Neaves	144, 152	HyungGun Park	117, 118
Shelley Metzenbaum	142, 149	Kimberly Nelson	80, 116, 164	Jaehee Park	96
Qing Miao	95	Milena Neshkova	77	Ji Hyung Park	79
Adam Miles	129	Chester Newland	130	Jinsol Park	124
Allyson Miller	194	Alexander Newman	122	June Park	176
Annie Miller	96	Jennifer Newman	183	Pooja Paswan	87, 150
Chad Miller	120, 146	Khanh Nguyen	156	Barbara Patrick	168
Geri Miller-Fox	89	Linda Nguyen	117	Ronny Patz	85
Cynthia Miller-Idriss	82	Ashley Nickels	155, 156	William Pelfrey	147
A.J. Million	181	Masami Nishishiba	167	Jesus Pena	87
H. Brinton Milward	174	Marina Nistotskaya	84	Shuyang Peng	140
Byung Hee Min	79	Xuejiao Niu	146	Leroy Perkins	185
Naon Min	201	Ozoemena Nnamadim	117	Robert Persichitte	148
Honey Minkowitz	179	Shihyun Noh	79	Stefan Perun	138
Roseanne Mirabella	94, 141, 156	Fron Nahzi	114	Saulat Pervez	82
Pamela Mischen	111	Tricia Nolfi	200	B. Guy Peters	86
David Mitchell	154	Douglas Noonan	136	James Pfiffner	121
Priti Mody-Pan	129	Zeeshan Noor	118	Jaclyn Piatak	183
Rakesh Mohan	95, 149	Kris Norman-Major	141	Christopher Pierce	81
Alisa Moldavanova	80	Stephen Northam	153	Jon Pierre	86
Astrid Molenveld	90	Katrina Norvell	155	Stephanie Pink-Harper	98
Kim Moloney	81, 86, 89, 143	Branda Nowell	175, 179	Jane Pisano	81, 107
Mehnaaz Momen	87	Philip Nufrio	94, 185	Mark Pisano	94, 120
M. Jae Moon	77, 84	Ethelbert Chinedu Nwokorie	175	Luis Antonio Pittol Trevisan	186
Seong-Gin Moon	179	John O'Brien	113	Cimone Philpotts	97
Goktug Morcol	111	Janine O'Flynn	138	Geoff Plimmer	140
Karina Moreno	175, 182	Rosemary O'Leary	91	Andrew Podger	82, 122
Laurence Morgana	166	Dongjin Oh	92	Shannon Portillo	197, 203
John Morris	92, 102	Jeongmin Oh	179	Thomas Poulin	140
Nancy Ann Morris	197	Namkyung Oh	172	Amelia Pridemore	107

PRESENTER DIRECTORY

Eric Prier	93	Sangyub Ryu	181	Todd Slater	138
Safiya Prysmakova	195	Shin Kue Ryu	189	Heidi Jane Smith	127, 196
Pierre-Charles Pupion	165	Meghna Sabharwal	87, 88, 139, 140, 184, 190	Robert Smith	185
Gabriel Puron Cid	78	Abdul-Akeem Sadiq	135	Jooyeon Song	199
Steven Putansu	168	Gwendolyn Saffran	156	Weiwei Song	115
Olga Pysmenna	163	Rauf Salahodjaev	89	Suparna Soni	84
Ahmad Qaisi	135	Ryan Salzman	189	Lucy Sorensen	129
Zhao Qi	109	Abdul Samad	197	Ismail Soujaa	136
Laura Quinby	95	Jose Cetina Sanchez	91	Jessica Sowa	138, 140, 176, 182
Jos Raadschelders	121, 127	Gopal Sanghaik	113	Sara Spiers	167
Hein Raat	116	Christina Sarrafian	125	Arwiphawee Srithongrung	97
Brooks Rainwater	91	Adam Sawyer	178	Anurag Kumar Srivastava	85
Bing Ran	111, 115, 164	Hiroki Sayama	111	Odd Stalebrink	127
Pamela Ransom	185, 202	Taylor Schafer	189	J. Allen Staley	146
Sukumar Rao	125	Samara Scheckler	182	Cristina M. Stanica	88, 96
Beth Rauhaus	112, 203	Steve Scheinert	153	Anthony Starke	168
Pragati Rawat	152	Lisa Schmidhuber	78	Jason Stear	172
Diane Raynes	154	Tracy Schober	117	Joshua Steinfeld	92, 102
Sara Reed	111	Rahel M. Schomaker	85	Carl Stenberg	89
Robert Reedy	189	Isla Schuchs Carr	203	John Stephens	149
Christopher J. Rees	83	Gary Schwarz	122	Randi Kay Stephens	173
Priscilla Regan	194	Ryan J. Scott	90, 172	Jeffrey Stern	135
Vincent Reitano	127	Gina Scutelnicu	123, 175, 190	Kelly Stevens	189
Christa Remington	135	Lydia Segal	139	Camille Stewart	135
Mei Ren	78	Mustafa Sen	169	Bethany Stich	154
Juanita Rendon	92	Efe Sevin	188	Merrett Stierheim	120
Rene Rendon	102, 103	Saahir Shafi	111	Eric Stokan	102
Rebecca Reyes	198	Aminata Shah	83	Roni Strier	166
Eunju Rho	170, 186	Shabana Shaheen	142	Rebekkah Stuteville	110
Norma Riccucci	130, 198	Razilya Shakirova	119	Nancy Stutts	201
Jay Rickabaugh	89, 90	Hongtao Shen	109	JiWon Suh	198
Grant Rissler	168	Yongdong Shen	165	Eddie Summers	101
Jason Rivera	82, 172	Jia Shi	82, 137	Jingran Sun	101
Charlene M. L. Roach	88, 139	Yu Shi	117	Qingqing Sun	78
Alasdair Roberts	86, 138	Wen-Chi Shie	199	Rusi Sun	92, 140
Gary Roberts	112	Margie Shields	95	Tao Sun	123
Cara Robinson	180	Patricia Shields	149, 182	Zongfeng Sun	116
Kent Robinson	128	William Shields, Jr.	80, 131	Liming Suo	165
Cristina Rodriguez-Acosta	108	Geiguen Shin	128	Christopher Surfus	141
Melvin Rogers	182	Tom Shoop	97	Kohei Suzuki	84
Stephen Rolandi	114	Alik Shpekbayer	131	James Svava	139
Aaron Rollins	168	Manoj Shrestha	95	Lina Svedin	108
Allan Rosenbaum	96, 150, 156, 170	Iuliia Shybalkina	123	Anne Swafford	111
David Rosenbloom	121, 128, 145, 201	Michael Siciliano	91, 153, 174	Wallace Swan	143
Ashley Ross	188	Saba Siddiki	178	Jennifer Swann	107, 155
Sharon Roth	176	Shariq Siddiqui	82	David Swindell	91
Ellen Rubin	195	Lais Silveira Santos	186	Richard Sylves	154
Marilyn Rubin	77	Lilia Silverio Minaya	124	Ben Tafoya	167
Wawrzyniec Rudolf	100	Anna Simonati	141	Jie Tan	172
Carol Rusaw	80	Shawn Skelly	107	Na Tang	128
Christine Rush	195	Thomas Skuzinski	90, 126	Shui-Yan Tang	77, 120
Jisun Ryu	95, 136			Tian Tang	98

PRESENTER DIRECTORY

Xukang Tang	174	Arnold Vedlitz	136	Paul Wiedefeld	176
Michele Tantardini	127	Adrian Velazquez Vazquez	183	Denis Wiering	117
Jie Tao	107, 136, 196	Curtis Ventress	186	Vicky Wilkins	194
Jill Tao	179	George Vernardakis	196	Alexis Willard	173
Geert Teisman	90	Shilpa Viswanath	87, 88, 190	Andrew Williams	153
Rebecca Tekula	190	Cynthia Vitters	194	Anthony Williams	107
Tao Teng	151	Morgan Vogel	96	Brian D. Williams	153
Jessica Terman	98, 194	Heidi Voorhees	107	Brian N. Williams	99, 130, 182
Hoa Thai	84, 162	Renaud Vuignier	100	Kaila Williams	144
Justin Theal	155	Lina Vyas	82	Kenneth Williams	185
Adam Thiel	135	Aaron Wachhaus	195	Linda Williams	168
Blair Thomas	188	Nora Wagner	85, 86	Nikki Williams	189
Najmah Thomas	202	Vanessa Walker Harris	142	Anne Williamson	100
Allison Thompson	129	Karen Wallace	202	Chauncia Willis	153
James Thompson	99	Sally Wallace	102	Katherine Willoughby	114, 173
Zoë Thorkildsen	201	Bo Wang	179	Darrin Wilson	188
Jeffrey Thorsby	195	Chongying Wang	123	Paris Wilson	175
Svanhildur Thorvaldsdottir	86	Chun-yuan Wang	177, 202	Wilson Wong	86
James Thurmond	187	Chunping Wang	165	Zachary Wood	156
Yuan Ting	119	Daan Wang	196	James Woods	118
Robert Tobias	129	Fei Wang	129	Alexandra Woodward	129
Rene Torenvlied	163	Hongchuan Wang	150	Blue Wooldridge	167, 190
Ador Torneo	89	Huanming Wang	138	Kitty Wooley	81
Shahnoza Tosheva	89	Qiushi Wang	121	Jeremy Worley	189
Evelyn Trammell	93	Weijie Wang	92	Nathaniel Wright	203
Rhonda Trautman	110	Wen-Jiun Wang	147, 188	Robert Wright	140
Sofia Trelles	181	Xiaoheng Wang	146	Alfred Muluau Wu	82, 127
Maren Trochmann	96	Xiaohu Wang	98	Jiannan Wu	98, 122
Jarle Trondal	85	Xuejun Wang	146	Jing Wu	177
Kuan-Chiu Tseng	92	Yingyao Wang	163	Liangfu Wu	155
James Tsugawa	195	Zhenzhen Wang	127	Long Wu	164
Krishna Tummala	87	Ziqi Wang	146	Viviana Chiu-Sik Wu	78
Eli Turkel	163	Leland Ware	94	Xi Xi	140
Jenna Tyler	136	Mildred Warner	90, 126	Zhiqiang Xia	177
Jack Underhill	202	Peter Warren	143	Jingjing Xiao	151
Mihai Ungureanu	88	Federickia Washington	119	Yan Xiao	118
Shahrin Upoma	150	Kathryn Webb Farley	112	Zhe Xiao	115
Valeriya Utkina	202	Shu Wei	115	Xiaoyu Xing	137
Bill Valdez	107, 184	Yuming Wei	147	Min Xiong	102, 171
Jesus N. Valero	119	Mindy Weinstein	169	Yao Xiong	121
Nick Valla	162	Gerard Wellman	180	Chengwei Xu	127
Arwin van Buuren	90	Laicheng Wen	172	Judy Xu	116, 121
Martijn van der Steen	90	Shihong Weng	164	Mengmeng Xu	122
Zeger van der Wal	86	Jared Wesley	100	Bo Yan	98, 165
Amy Van Grieken	117	Jonathan West	139	Huishan Yang	201
Jitske van Popering-Verkerk	90	Laura Wheeler	110	Kaifeng Yang	77, 98, 113, 123, 137, 145, 150, 201
David Van Slyke	130	Theresa Whelan	194	Lang (Kate) Yang	79
Montgomery Van Wart	148	Travis Whetsell	103, 153	Libo Yang	151, 164
Arturo Vargas	184	Harvey White	167	Qiaoyun Yang	147
Triparna Vasavada	198	Joe Wholey	95	Seung-Bum Yang	89
Leila Vaughan	152	Serena Wider	100		

PRESENTER DIRECTORY

Sunny Yang	116	Changgeun Yun	197	Yi Zhang	109
Yuze Yang	165	Claire Jung Ah Yun	200	Ying Zhang	109
Susan Yarwood	194	Shamshod Yunusov	89	Youlang Zhang	136
Franklin Yayra Adorsu-Djentuh	83, 87	Wie Yusuf	152	Yunxiang Zhang	162
Lin Ye	165	Joshua Zaato	180	Diyang Zhangnan	137
Jungwon Yeo	127, 148, 153, 198	Staci Zavattaro	100, 138, 183, 188	Huizeng Zhao	136, 187
Chun Ho Yeom	199	Urszula Zawadzka-Pak	117	Jianzhi Zhao	92, 124
Srinivas Yerramsetti	125	Tatiana Zaytseva	121	Zhirong Zhao	103, 122, 151, 171, 172
Eunsil Yoo	111, 199	Eric Zeemering	79	Lianhu Zheng	137
Jungmo Yoo	199	Aziza Zembrani	93, 120, 183	Ye Zheng	165
Kun Yoon	109	Jingjing Zeng	145	Yueping Zheng	171
Nara Yoon	97	Kun Zhai	170	Hui Zhou	143
Taewon Yoon	201	Yu Zhai	151	Na Zhou	127
Helen Yu	198	Guoxing Zhang	146	Qian Zhou	135
Jianxing Yu	123	Hong Zhang	146, 189	Ling Zhu	143
Junli Yu	109, 150	Liang Zhang	165	Renxian Zhu	164
Wenxuan Yu	164	Liwei Zhang	173	Zhengwei Zhu	187
Yiwei Yu	189	Nandiyang Zhang	196	Hejia Zhuo	151
Meng Yuan	145	Pengju Zhang	79	Asim Zia	148
Qianli Yuan	162	Weiwen Zhang	150	Julia Zobel	194
Zhang Yue	116	Yahong Zhang	116, 164	Corri Zoli	135

WE DEFINE THE Future

Advance your career with a Master of Public Administration Degree from Cal State San Bernardino

- Nationally Accredited by NASPAA
- Committed to Ethical Public Service
- Online or On-campus
- Optional Concentrations in:
 - Leadership
 - Public Financial Management
 - Cyber Security (classes on-campus only)

Montgomery Van Wart, Professor

NASPAA ACCREDITED
The Commission on Peer Review & Accreditation

jhbc.csusb.edu/mpa

CALIFORNIA STATE UNIVERSITY SAN BERNARDINO
Jack H. Brown College
Business and Public Administration



NYU | WAGNER

**TURN
YOUR
PASSION
INTO
ACTION**

**Make an effective
and lasting impact
on cities across the world.**

OUR DEGREE PROGRAMS

Using the thriving setting of NYC as an urban laboratory, NYU Wagner offers an interdisciplinary and innovative curriculum that allows you to hit the ground running when you graduate.



9th OVERALL

- **#1** in Health Policy & Management
- **#2** in Urban Policy
- **#6** in Nonprofit Management
- **#6** in Public Finance & Budgeting
- **#7** in Social Policy
- **#7** in Local Government Management
- **#10** in Public Management & Leadership

MASTER OF PUBLIC ADMINISTRATION

Public & Nonprofit Management & Policy
Health Policy & Management

MASTER OF URBAN PLANNING

MASTER OF SCIENCE IN PUBLIC POLICY

EXECUTIVE MASTER OF PUBLIC ADMINISTRATION

NEW! **ONLINE MASTER OF
HEALTH ADMINISTRATION**

wagner.nyu.edu

For more information: wagner.admissions@nyu.edu

ASPA LIFE MEMBERS

F. Daniel Ahern	Andrew Ewoh	Naomi Lynn	H. Arthur Sauer
Myrta Anderson	Louis Filik	Keith Martensen	Oliver Schepers
Jeffrey Ashley	Michael Fischetti	Robert Maslyn	Helen Schlichte
Robert Lee Averett	Patricia Florestano	Audrey Mathews	Donna Shalala
Wayne Bailey	Barry Friedman	Linda McNish	Frank Sherwood
John Bartle	Edmund Fulker	Donald Menzel	Bruce L. R. Smith
Julia Beckett	Jean-Claude Garcia-Zamor	Betty Meyer	Christine Gibbs Springer
Larry Beckon	Susan T. Gooden	Michael Milakovich	Robert Sprinkle
RaJade Berry-James	Doug Goodman	Hugh Miller	Thomas Stanton
Guido Bertucci	James Grant	Richard Miller	Douglas Stark
Beverlee Bickmore	Mary Hamilton	William Miller	Richard Stillman
Don Blandin	Lenneal Henderson	Matthew Mingus	Ronald Stupak
Nanette Blandin	Charles Henry	Mary Lou Mogenhan	Dorothy Sullivan
Pamela Bloomfield	Laurin Henry	Robert Montjoy	James Svara
Harold Boldt	Kathryn Hensley	M. Jae Moon	Kurt Thurmaier
James Bowman	Adam Herbert	John Morris	Krishna Tummala
Ann Hess Braga	Harlan Hobgood	Ricardo Morse	Edward Twardy
Cheryle Broom	Marc Holzer	Claire Mostel	David Twigg
Richard Callahan	Dwight Ink	Patrick Mullen	James Ward
James Carr	D.C. Jensen	Lisa Nelson	H.G. Webb
Paul Chalekian	Prabhakar Joshi	Chester Newland	David Weimer
Yu-Che Chen	Herbert Kaufman	Kenneth Nichols	Danny Weiss
Beverly Cigler	Lawrence Keller	James Nordin	Harvey White
Doreen Clifford	Roger Kemp	Charles Norris	Charles Wilcox
Jerrell Coggburn	Anne Osborne Kilpatrick	Philip Nufrio	Dona Wolf
Jeanne-Marie Col	Donald Klingner	Rosemary O'Leary	Patricia Yearwood
Margery Coulson-Clark	Heidi Koenig	Elaine Orr	Alfred Zuck
Belle Davis	Philip Kronenberg	Shelly Pepper	
Wallace Davis	William Lambert	Cary Racine	
Patria de Lancer Julnes	G. Zhiyong Lan	Leonard J. Richards	
Linda deLeon	Jamie Langlie	William Roberts	
Leonard Desautelle	William Lardie	Randy Robinson	
Craig Donovan	Wendell Lawther	Kathy Boyd Rochedieu	
Melvin Dubnick	Deborah LeBlanc	Allan Rosenbaum	
Frances Edwards	Cynthia Lynch	Antoinette Samuel	
Mona Elien	Thomas Lynch	Dolph Santello	

ASPA CHARTER MEMBERS

Lyndon Abbott
Clark D. Ahlberg
George C.S. Benson
David S. Brown
Weldon Cooper
John Corson
Winston W. Crouch
J. Lyle Cunningham
Manilio F. DeAngelis
Marshall E. Dimock
William O. Farber
James Fesler
Arthur S. Flemming
Donald D. Fowler
Bernard L. Gladieux
Ernest S. Griffith
Clifford S. Gross
Luther H. Gulick
Lowell H. Hattery

Julia Henderson
Janet L. Hoffman
George W. Lawson
Verne B. Lewis
Kent Mathewson
Elwyn A. Mauck
E.W. Meisenhelder
James M. Mitchell
Frederick C. Mosher
Lionel V. Murphy
Milton Musicus
Enar B. Olson
William W. Parsons
Frank Piskor
Joseph Pois
Donald K. Price
John R. Provan
Albert R. Rathert
Robert H. Rawson

Emmett S. Redford
Harold Seidman
Irving E. Sheffel
Lewis B. Sims
Elmer B. Staats
O. Glenn Stahl
John Stanford
David T. Stanley
Edwin O. Stene
Donald C. Stone
Harold A. Stone
Carl W. Tiller
Paul Van Riper
Richard W. Van Wagenen
Robert A. Walker
Hardy Wickwar
Edgar G. Young
Virgil B. Zimmerman

ASPA MEMBERS CELEBRATING 50 YEARS

Larry Beckon
Robert Denhardt
Bond Faulwell
Edmund Fulker
Parris Glendening

Lloyd Hara
Linda McNish
David Rosenbloom
Alan Sager
H. Arthur Sauer

Douglas Stark
H. G. Webb
Robert Wheland
Charles Wise
Dona Wolf

ASPA MEMBERS CELEBRATING 25 YEARS

James Brunet
Yong Cho
Javier Font
Edward French
David Gattis
John Gillison
Jennifer Glazer-Moon

Akhlaque Haque
Robin Larson
L. Frances Liddell
Sarmistha Majumdar
Mary Maloney
Charles Mitchell
Brian Pabst

Alasdair Roberts
James Shuler
Christopher Simon
Kendra Stewart
Carol Traut
Steven Whitlock

The ASPA Annual Conference is built on an important framework: Bringing together those committed to the public good is an important purpose that supports the Society's mission of *advancing excellence in public service*. A freeflowing exchange of ideas and educational interchange are important and necessary for advancing the art, study, teaching and practice of public administration, as well effective professional development for those invested in our field.

In support of these goals, ASPA is committed to providing a safe, welcoming and inclusive environment for all conference participants. We also are committed to providing an environment that is free from harassment or discrimination in all its forms, including age, race, ethnicity, national origin, religion, language, sexual orientation, gender identity or expression, disability, health, socioeconomic status, marital status, domestic status, parental status, physical appearance or body size. Such conduct is contrary to ASPA's values and high standards of ethical practice. These standards include the principles of treating all persons with fairness, justice and equality; respecting individual differences, rights and freedoms; and promoting affirmative action and other initiatives to reduce unfairness, injustice and inequality in society.

Further, such conduct is contrary to ASPA's Code of Ethics, which all members promise to support. Specifically, it violates the principles of promoting democratic participation; strengthening social equity; demonstrating personal integrity; and advancing professional excellence.

This Code of Conduct outlines the expectations by which all participants shall abide during the ASPA Annual Conference, conference-related activities, social events and other ASPA-sponsored events in which participants are gathered. Participants include but are not limited to member and non-member attendees, speakers, public officials, staff, contractors, vendors, exhibitors, sponsors, awardees, guests and volunteers.

Expected Behavior

ASPA expects all participants to:

1. Present themselves, interact and communicate in a professional and constructive manner, whether in person or virtually.
2. Handle dissent or disagreement with courtesy, dignity and an open mind. Be respectful when providing feedback.
3. Be sensitive to and respectful of cultural contexts that vary among regions within the United States and abroad, reflecting ASPA's global membership and reach.
4. Wear their conference badge during all conference-related programming and present it upon request by staff or other event personnel.
5. Be honest and truthful about any questionable behavior they witness on the part of any meeting participant when reporting it to ASPA staff or leadership. Report behavior as soon as possible after witnessing it.

Unacceptable Behavior

1. Harassment, intimidation or discrimination in any form will not be tolerated.
 - a. *Harassment* consists of a single or multiple persistent or pervasive acts that are demeaning, abusive, offensive or create a hostile professional environment. It may include unwelcome sexual solicitation, physical advances or verbal or non-verbal conduct that is sexual in nature; threatening, intimidating or hostile acts; circulation of written or graphic material denigrating or showing hostility toward an individual or group; or epithets, slurs or negative stereotyping based on group identity. Harassment may take place either in person or through digital channels including social media outlets.
 - b. *Sexual harassment* includes, but is not limited to, unwelcome sexual advances, requests for sexual favors, and other verbal or physical conduct of a sexual nature. Behavior and language that are welcome or acceptable to one person or culture may be unwelcome and offensive to another. Examples of behavior that, when unwelcome, constitute sexual harassment include sexual flirtations, advances, or propositions; verbal comments or physical actions of a sexual nature, including sexually degrading words used to describe an individual; making unwelcome comments about someone's physical appearance; a display of sexually suggestive objects or pictures; sexually explicit jokes; unwanted touching; and persistent and unwelcome solicitation of emotional or physical intimacy. Sexual harassment may take place either in person or through digital channels including social media outlets.
2. Verbally or physically abusive behavior toward others during the ASPA conference will not be tolerated. This behavior includes bullying, profanity directed toward

others, property damage, deliberate intimidation or stalking, harassing photography or recording, physical assault, real or implied threat of physical harm.

3. Disruption of speakers, presenters or any individuals engaged in the public presentation of conference-related content.

Consequences of Unacceptable Behavior

1. Engaging in unacceptable behavior as described in this Code of Conduct may result in being asked to leave the event and/or being barred from future events.
2. Anyone requested to cease unacceptable behavior is expected to comply immediately. ASPA staff, hotel personnel or security may take any action deemed necessary and appropriate. If necessary, law enforcement will be engaged.
3. Infractions of the Code of Conduct on the part of ASPA members may be referred to the ASPA Executive Committee and/or the Ethics and Standards Implementation Committee for review and resolution. As stated in the bylaws, the National Council may terminate membership or impose other sanctions on members following investigation and recommendation by the Ethics and Standards Implementation Committee for a serious violation of the Society's Code of Ethics. Infractions of this Code of Conduct may be interpreted to also violate several tenets of the Code of Ethics, including but not limited to promoting democratic participation, strengthening social equity, demonstrating personal integrity and advancing professional excellence. In order to be acted upon in a timely fashion, infractions must be reported within 90 days of the occurrence in order for a review to take place.

Reporting Unacceptable Behavior

The safety and security of our attendees is our most important priority. If you are the subject of unacceptable or inappropriate behavior at the conference, notice that someone else is being harassed or have any other concerns, please notify an ASPA staff member immediately. They will be available to assist in contacting hotel/venue security or local law enforcement, provide escorts or otherwise assist those experiencing harassment to feel safe for the duration of the event. In the case of emergency, or if you cannot locate an ASPA staff member, please contact a hotel or venue staff member or security. We expect participants to be honest and truth about any questionable behavior they witness on the part of any meeting participant when reporting it to ASPA staff or leadership. Please report behavior as soon as possible after experiencing or witnessing it so that ASPA can take prompt remedial action.

Staff can be located at the event registration desk throughout operating hours, the ASPA membership booth during exhibit hall hours, and in all plenary sessions, Presidential Panels and officially sponsored receptions. Staff wear badges with a visible Staff ribbon. You also may email aspaconference@aspanet.org for assistance.

Please refrain from reporting unacceptable behavior through social media channels, as ASPA's channels are not monitored 24/7 and your report may not be seen in a timely fashion.



VCU

L. Douglas Wilder School of
Government and Public Affairs

The VCU Wilder School

Leading at ASPA and Beyond

FACULTY



Susan T. Gooden
Interim Dean

**2019 JOAN FISS BISHOP
LEADERSHIP AWARD**

Presented by ASPA's Section for Women in Public Administration, the Fiss Bishop Award recognizes an honoree's continuous commitment

to the promotion of women's participation in the public sector and a defined contribution to professional service.



Blue Wooldridge
Professor

**2019 PAUL VAN RIPER AWARD
FOR EXCELLENCE AND
SERVICE**

Presented by ASPA, the Van Riper Award honors a nationally recognized leader and innovator in the practice

and teaching of personnel administration.



Myung H. Jin
Associate Professor

Newly elected **REPRESENTATIVE
FOR DISTRICT II OF ASPA'S
NATIONAL COUNCIL**. In October,

Jin was awarded the NASPAA Phi Alpha Alpha Chapter Advisor Award of Excellence.

We salute the Wilder School faculty and students who will be recognized at this year's annual conference of the American Society for Public Administration for their outstanding scholarly and professional contributions.

DOCTORAL CANDIDATES

Sombo Chunda

**2019 WALTER MODE
SCHOLARSHIP
RECIPIENT**

Awarded by the ASPA Endowment, the Mode Scholarship provides support for a graduate student with a demonstrated commitment to public service. Chunda, who has a distinguished record in international development, studies corruption, accountability and gender.



Suparna Dutta

FOUNDERS' FELLOW

Dutta has been selected as a 2019 ASPA Founders' Fellow. She studies social equity and inclusion in the context of organizational behavior and community development.



Located just blocks from the Virginia Capitol and a two-hour drive from the nation's capital, the Wilder School offers undergraduate, graduate and doctoral degrees in criminal justice, homeland security and emergency preparedness, public administration, public policy and administration, and urban and regional studies and planning, plus graduate certificates in related fields. The school ranks among the top 50 of the nation's best graduate public affairs programs—moving up 12 places to No. 44 in the 2019 U.S. News & World Report rankings.

Recent Influential Research from Rutgers SPAA

PUBLIC FINANCE AND BUDGETING



Cleopatra Charles, PhD
Associate Professor

"Nonprofit Arts Organizations: Debt Ratio Does Not Influence Donations – Interest Expense Ratio Does," *The American Review of Public Administration*



Charles Menifield, PhD
Dean

The Basics of Public Budgeting and Financial Management: A Handbook for Academics and Practitioners (3rd Edition), Hamilton Books



Jongmin Shon, PhD
Assistant Professor

"State-Local Sales Tax, Spillover, and Economic Activity: Examining County Governments in the U.S.," *Local Government Studies*



Pengju Zhang, PhD
Assistant Professor

"The Unintended Impact of Tax and Expenditure Limitations on the Use of Special Districts: the Politics of Circumvention," *Economics of Governance*

NONPROFIT MANAGEMENT



Weiwei Lin, PhD
Assistant Teaching Professor

"Revisiting Revenue Diversification in Nonprofit Organizations: A Meta-Analysis," Association for Research on Nonprofit Organizations and Voluntary Action (ARNOVA) Conference



Jiahuan Lu, PhD
Assistant Professor

"Does Population Heterogeneity Really Matter to Nonprofit Sector Size? Revisiting Weisbrod's Demand Heterogeneity Hypothesis," *Voluntas: International Journal of Voluntary and Nonprofit Organizations*



Lindsey McDougale, PhD
Associate Professor

"Experiential Philanthropy," *Global Encyclopedia of Public Administration, Public Policy, and Governance*



Lois Warner, PhD

Assistant Teaching Professor
"Cultural Participation and Community Development: 21st Century Newark, NJ," Northeast Conference on Public Administration (NECoPA)

PUBLIC MANAGEMENT AND LEADERSHIP



Sebastian Jilke, PhD
Assistant Professor

"Behavioral Public Administration: Combining Insights from Public Administration and Psychology," *Public Administration Review*



Suzanne Piotrowski, PhD
Associate Professor

"Levels of Value Integration in Federal Agencies' Missions and Value Statements: Is Open Government a Performance Target of U.S. Federal Agencies?" *Public Administration Review*



Norma Riccucci, PhD
Board of Governors Distinguished Professor

Public Personnel Management: Current Concerns, Future Challenges (6th Edition), Routledge



Gregg Van Ryzin, PhD
Professor

"Prospects for Experimental Approaches to Research on Bureaucratic Red Tape," *Experiments in Public Management Research: Challenges and Contributions*